

**Copyright**

**By**

**Scott Jacob McCord**

**2012**

The Thesis committee for Scott Jacob McCord  
Certifies that this is the approved version of the following thesis:

**Testing of Emergency Wood Shoring Towers for use in Urban Search  
and Rescue Operations**

**APPROVED BY  
SUPERVISING COMMITTEE:**

---

**Michael D. Engelhardt, Co-Supervisor**

---

**Dan L. Wheat, Co-Supervisor**

**Testing of Emergency Wood Shoring Towers for use in Urban Search  
and Rescue Operations**

by

**Scott Jacob McCord, B.S.**

**Thesis**

Presented to the Faculty of the Graduate School of  
The University of Texas at Austin  
in Partial Fulfillment  
of the Requirements  
for the Degree of

**Master of Science in Engineering**

**The University of Texas at Austin**

**May 2012**

## **Dedication**

To God, through whom all things are possible, and all good things emanate from.

To my wife Jaimee, her unfailing love and support saw me through this accomplishment.

To my parents, the catalysts for which my life was shaped.



## **Acknowledgements**

First, I would like to thank the Department of Homeland Security and Protection Engineering Consultants for providing the funding for my project and master's education. Both have been very rewarding.

The professors and staff at Ferguson Laboratory who have impacted me both in the classroom and through professional mentoring. These individuals in coordination with the technicians at Ferguson have provided a unique learning opportunity for students to better the field of engineering. In particular, I want to thank the professors on my project, Dr. Mike Engelhardt, and Dr. Dan Wheat. Both have contributed significantly to the progress and success of this project, for which I am appreciative. In addition, I would like to extend a special thank you to Dr. Mike Engelhardt who was an amazing resource over the course of the research and also became invested in my success as future design engineering. Dr. Engelhardt assisted with this thesis and made numerous contributions to the project over the past two years, but most importantly he was a mentor throughout the project scope. Dr. Engelhardt was very active in my search for employment, providing references to many firms and much advice. Also, the project benefited many times from the instrumentation expertise of Eric Shell. Eric programmed and controlled the actuators for every test and his small inventions helped streamline the testing procedure.

I have enjoyed working with the many great students at Ferguson, especially Steven Blair and Whitney Lee who worked tirelessly with me on this project without funding.

It is difficult to condense my wife's and my family's encouragement into only a few words. So, I will simply state that their love and support have made me who I am today and provided me with the strength to endure the difficult times and the confidence to accomplish this lifetime achievement. Thank you.

May 2012

# **Testing of Emergency Wood Shoring Towers for use in Urban Search and Rescue Operations**

by

Scott Jacob McCord, M.S.E.

The University of Texas at Austin, 2012

SUPERVISORS: Michael Engelhardt and Dan Wheat

Emergency wood shoring towers are utilized by Urban Search & Rescue (US&R) specialists to temporarily stabilize a damaged structure. Standardized designs for wood shoring towers have been developed and are published in manuals for use in US&R operations. These designs have been validated largely through past testing under simplified vertical loading. Research was conducted to provide additional insight into the performance of two common types of shores, the laced post (LP) shore and the plywood laced post (PLP) shore, under non-ideal (other than vertical) loading scenarios. Shores were tested under vertical load only, under lateral load only, and under combined vertical and lateral load. For lateral loading, some shores were tested under monotonic lateral load (lateral load applied in one direction only) and some were tested under cyclic lateral loading. Each specimen was tested to failure, and the documented capacity compared to the FEMA specified shore design capacity. Early warning signs of shore distress known as “fuses” characterized by audible cracking sounds, cupping of the wedges, or cracking

of members were also evaluated during testing for their effectiveness and consistency. The performances of the laced post and plywood laced post shores were compared and recommendations made.

## Table of Contents

<b>CHAPTER 1 INTRODUCTION</b>	<b>1</b>
1.1 US&R Wood Shoring Background.....	1
1.2 Research Objectives.....	2
1.2.1 Shore Capacity under Non-Ideal Loading Scenarios.....	2
1.2.2 Evaluate Performance under Combined Vertical and Lateral Loading.....	2
1.2.3 Evaluate Performance under Load-Control versus Displacement Control Tests.....	3
1.2.4 Identify Design Weaknesses and Recommend Improvements.....	4
1.2.5 Evaluate Emergency Fuses.....	4
1.2.6 Compare LP and PLP Designs.....	4
1.3 Project Overview and Scope of Thesis.....	5
<b>CHAPTER 2 BACKGROUND</b>	<b>7</b>
2.1 Material Properties of Wood.....	7
2.1.1 Classifications of Wood.....	7
2.1.2 Cellular Structure of Wood.....	8
2.1.3 Wood as an Orthotropic Material.....	8
2.1.4 Impact of the Visual Grading System.....	9
2.1.5 Design Properties.....	11
2.1.6 Environmental Factors.....	12
2.1.7 Loading Rate of Wood.....	12
2.2 Defining Emergency Shoring.....	12
2.3 Types of US&R Shores.....	14
2.3.1 Standard Laced Post Shore.....	18
2.3.2 Plywood Laced Post Shore.....	19

2.4	Fuses: Early Overload Detection .....	21
2.5	Shore Design Capacity.....	24
2.5.1	Summary of Bearing Capacity Design Calculations .....	24
2.5.2	Buckling Capacity Design Calculations .....	24
2.5.3	Buckling versus Bearing Design Loads.....	25
2.6	Connection Properties and Capacities .....	25
2.6.1	2x4 Brace Connection: 3 Nails .....	26
2.6.2	Plywood Brace Connection: 14 Nails.....	28
2.7	Previous Testing by US&R.....	29
2.7.1	FEMA StS-2 Training: Testing and Results - March 2001 - March 2005 .....	30
2.7.2	FEMA StS-2 Training: Testing and Results - November 2005 - May 2006 .....	32
2.7.3	FEMA StS-2 Training: Testing and Results - May 2007 - May 2010.....	35
2.7.4	Summary of FEMA StS-2 Training Test Results .....	36
<b>CHAPTER 3 EXPERIMENTAL SETUP</b>		<b>41</b>
3.1	Loading Requirements .....	41
3.1.1	Vertical Loading .....	41
3.1.2	Lateral Loading.....	42
3.1.3	Loading Interface .....	42
3.1.4	Tilt versus Level Loading.....	42
3.2	Loading System .....	43
3.2.1	Loading Frame and Actuators.....	43
3.2.2	Concrete Slab Design.....	45
3.2.3	Safety Features.....	46
3.2.4	Limitations of the Test Setup.....	50

3.2.5	Specimen Slip Brackets .....	51
3.3	Instrumentation and Documentation.....	52
3.3.1	Actuator Data .....	52
3.3.2	Structural Response Data Collection .....	52
3.3.3	Photographic and Video Documentation .....	53
3.4	Test Matrix and Loading Scenarios .....	55
3.4.1	Loading Scenario A .....	57
3.4.2	Loading Scenario B.....	57
3.4.3	Loading Scenario C.....	58
3.4.4	Loading Scenario D .....	58
3.4.5	Loading Scenario E.....	58
3.4.6	Loading Scenario F.....	59
<b>CHAPTER 4 SPECIMEN DESIGN AND CONSTRUCTION</b>		<b>60</b>
4.1	Key Test Specimen Features.....	60
4.1.1	Dimensional Restrictions .....	60
4.1.2	Lumber Species.....	60
4.2	Nail Requirements .....	62
4.3	Specimen Design .....	63
4.3.1	Laced Post Shore Design .....	64
4.3.2	Plywood Laced Post Shore Design.....	70
4.4	Review of Fuses.....	75
4.5	Shore Construction Process .....	77
4.5.1	Laced Post Fabrication Process .....	77
4.5.2	Plywood Laced Post Fabrication Process .....	83
4.5.3	Construction Observations.....	88

<b>CHAPTER 5 TEST RESULTS</b>	<b>89</b>
5.1 Test Specimen 1 .....	91
5.2 Test Specimen 2 .....	96
5.3 Test Specimen 3 .....	100
5.4 Test Specimen 4 .....	105
5.5 Test Specimen 5 .....	110
5.6 Test Specimen 6 .....	117
5.7 Test Specimen 7 .....	122
5.8 Test Specimen 8 .....	127
5.9 Test Specimen 9 .....	133
5.10 Test Specimen 10 .....	139
5.11 Test Specimen 11 .....	144
5.12 Test Specimen 12 .....	150
5.13 Test Specimen 13 .....	154
 <b>CHAPTER 6 OBSERVATIONS AND ANALYSIS</b>	 <b>161</b>
6.1 Summary of Capacities .....	161
6.2 Comparison to FEMA US&R Test Results .....	162
6.3 Effects of Non-cyclic Lateral Displacement .....	164
6.4 Effects of Cyclic Loading .....	166
6.5 Effects of Vertical Loading Rates .....	167
6.6 Impact of Initial Out-of-Plumb .....	169
6.7 Performance of Laced Post (LP) versus Plywood Laced Post (PLP) .....	171

6.7.1	Comparison of Vertical Capacity.....	172
6.7.2	Comparison of Lateral Stability.....	172
6.7.3	Comparison of Cyclic Load Performance.....	173
6.8	Performance and Reliability of Emergency Fuses.....	174
6.9	Connection Failures .....	177
6.9.1	LP Brace Connection Failures .....	177
6.9.2	PLP Brace Connection Failures .....	179
<b>CHAPTER 7 CONCLUSIONS</b>		<b>181</b>
7.1	Behavior under Vertical Loading.....	182
7.2	Behavior under Lateral and Combined Vertical/Lateral Loading .....	183
7.3	Laced Post (LP) versus Plywood Laced Post (PLP) Design.....	184
7.4	Performance and Reliability of Emergency Fuses.....	184
7.5	Further Research Needs .....	185
<b>APPENDIX A DESIGN CALCULATIONS FOR SHORES AND CONNECTIONS</b>		<b>187</b>
A1.	Bearing Capacity: Southern Yellow Pine No. 1 Dense .....	187
A2.	Bearing Capacity: Southern Yellow Pine No. 1 (Used in this Investigation).188	
A3.	Bearing Capacity: Douglas Fir-Larch No. 1 .....	188
A4.	Buckling Capacity: Southern Yellow Pine No. 1 (Used in this Investigation): .....	188
A5.	2x4 Brace Connection Design Calculations (3 Nails): Single Shear .....	190
A6.	2x4 Brace Connection Design Calculations (3 Nails): Withdrawal .....	192
A7.	Plywood Brace Connection Design Calculations (14 Nails): Single Shear....	193
A8.	Plywood Brace Connection Design Calculations (14 Nails): Withdrawal .....	195



<b>APPENDIX B LOADING FRAME DETAILS</b>	<b>197</b>
<b>REFERENCES</b>	<b>200</b>

## List of Tables

Table 2-1 Table of Results for Laced Post Shores (Hammond, 2011) .....	37
Table 2-2 Table of Results for 4ft x 4ft Plywood Laced Post Shores (Hammond, 2011) .....	37
Table 2-3 Table of Results for 2ft x 4ft Plywood Laced Post Shores (Hammond, 2011) .....	38
Table 3-1 Test Matrix .....	56
Table 4-1: Comparison of the Material Properties of Douglas Fir-Larch and Southern Yellow Pine .....	61
Table 4-2 Procedure Used to Construct a Laced Post Shore .....	77
Table 4-3 Procedure Used to Construct a Plywood Laced Post Shore .....	83
Table 5-1 Details for Test Specimen 1 .....	91
Table 5-2 Details for Test Specimen 2 .....	96
Table 5-3 Details for Test Specimen 3 .....	100
Table 5-4 Details for Test Specimen 4 .....	105
Table 5-5 Details for Test Specimen 5 .....	110
Table 5-6 Details for Test Specimen 6 .....	117
Table 5-7 Details for Test Specimen 7 .....	122
Table 5-8 Details for Test Specimen 8 .....	128
Table 5-9 Details for Test Specimen 9 .....	133
Table 5-10 Details for Test Specimen 10 .....	139
Table 5-11 Details for Test Specimen 11 .....	144

Table 5-12 Details for Test Specimen 12 .....	150
Table 5-13 Details for Test Specimen 13 .....	154
Table 6-1 Summary of Vertical Capacities.....	162
Table 6-2 Comparison of Vertically Loaded LP Shore Capacities.....	163
Table 6-3 Comparison of Vertically Loaded PLP Shore Capacities .....	163
Table 6-4 Non-Cyclic Lateral Displacement Test Results .....	165
Table 6-5 Cyclic Loading Test Results.....	167
Table 6-6 Comparison of PLP Vertical Displacements at Peak Load .....	168
Table 6-7 Loading Rate Test Results.....	168
Table 6-8 Initial Out-of-Plumb Comparison Data .....	170
Table 6-9 Comparison of Non-ideal Loading Sequence Results for LP and PLP .....	172
Table 6-10 Force Required to Displace Laterally.....	172
Table 6-11 Cyclic Loading Sequence Performance Comparison .....	173
Table 6-12 Qualitative Analysis of Emergency Fuses.....	175
Table 6-13 Vertical Deformations at Peak Capacity .....	176

## List of Figures

Figure 2.1 Longitudinal (L), Radial (R) and Tangential (T) Directional Axes .....	9
Figure 2.2 Common Types of Growth Imperfections.....	10
Figure 2.3 Table 4B Reference Values for Southern Yellow Pine (NDS 2005) .....	11
Figure 2.4 Conceptual Diagram of the Double Funnel Principle (O'Connell, 2006) .....	14
Figure 2.5 Standard Class 1 Shore (USACE FOG 2009).....	15
Figure 2.6 Laced Post Class 2 Shore (Left) and Plywood Laced Post Class 2 Shore (Right), (USACE FOG 2009).....	16
Figure 2.7 Standard Laced Post Class 3 Shore (USACE FOG 2009) .....	17
Figure 2.8 Computer Generated Model of a Laced Post Shore .....	18
Figure 2.9 Plywood Laced Post Shore Specifications, 4ft x 4ft Base (Left), 2ft x 4ft Base (Right), (USACE FOG 2011) .....	20
Figure 2.10 Wedge Design Details and Photographs A) Installed Wedge with No Load B) Installed Wedge Cupping Under Load .....	22
Figure 2.11 Split Header Due to Overload, (FEMA StS2 Summary- Testing of Laced Post & Plywood Laced Posts, 2011) .....	23
Figure 2.12 Brace Nailing Patterns A) 2x4 Connection B) 24in Plywood Brace Connection .....	26
Figure 2.13 Connection Yield Modes (Figure I1 NDS 2005) .....	27
Figure 2.14 OARF Loading Apparatus (FEMA StS2 Summary- Testing of Laced Post & Plywood Laced Posts, 2011).....	30
Figure 2.15 Three LP Test Designs A) Reverse K B) Standard K C) Two Bay Parallel Diagonals (FEMA StS2 Summary- Testing of Laced Post & Plywood Laced Posts, 2011) .....	31

Figure 2.16 Examples of PLP Designs Tested A) 2-12in Braces B) 3-12in Braces C) 1-24in Brace D) 2-24in Braces (FEMA StS2 Summary- Testing of Laced Post & Plywood Laced Posts, 2011).....	33
Figure 2.17 Lateral Torsional Buckling of Plywood Braces (FEMA StS2 Summary- Testing of Laced Post & Plywood Laced Posts, 2011).....	34
Figure 2.18 Buckling of Individual Plies in Plywood Braces (FEMA StS2 Summary- Testing of Laced Post & Plywood Laced Posts, 2011).....	35
Figure 2.19 Examples of PLP Specimen Designs (FEMA StS2 Summary- Testing of Laced Post & Plywood Laced Posts, 2011).....	36
Figure 2.20 Highest Capacity (LP-63), Proposed Standard PLP Design (PLP-84,85).....	38
Figure 2.21 Standard 2ft x 4ft Plywood Laced Post Shore (USACE FOG 2011).....	39
Figure 3.1 Loading Frame A) Front (Plan) View B) Side View .....	43
Figure 3.2 Loading Frame A) Computer Generated Model of Loading Frame B) Photograph of Frame C) Photograph of Horizontal Actuator.....	45
Figure 3.3 Concrete Slab Detail A) Front View B) Side View .....	46
Figure 3.4 Locations of Lateral Braces A) Plan View B) Side View .....	47
Figure 3.5 Photographs of Lateral Bracing A) Side View B) Strong Wall Attachment C) L-frame Attachment .....	48
Figure 3.6 Safety Shore A) Design Drawing B) Photograph of Shore in Place .....	49
Figure 3.7 Emergency Shutoff Switches A) Locations of Switches B) Photograph of Emergency Shutoff Switch.....	50
Figure 3.8 Slip Brackets A) Seven Locations B) Photograph of Header Brackets C) Photograph of Sole Bracket .....	51
Figure 3.9 Secondary Data Collection A) Example of String Potentiometer Locations B) Photograph of a Lateral Potentiometer C) Vertical Potentiometer Offset.....	53

Figure 3.10 Member Identification Code Designations.....	54
Figure 3.11 Example of a Member ID Code: Shore #1, Base Plate, Ground Level, Back Side - Facing the Back.....	55
Figure 4.1 Nailing Patterns used for Laced Post Shores.....	63
Figure 4.2 Nailing Patterns used for a Plywood Laced Post Shores.....	63
Figure 4.3 US&R FOG Laced Post Shore Design Details.....	65
Figure 4.4 Design Drawing of the Base of a LP Shore.....	67
Figure 4.5 Wedge Design A) Drawing Detail B) Photograph of Wedge .....	68
Figure 4.6 Laced Post As-Built Drawing.....	69
Figure 4.7 Photographs of Constructed LP Shores.....	70
Figure 4.8 Design Drawing of the Header of a PLP Shore.....	71
Figure 4.9 Design Drawing for the Base of a PLP Shore .....	72
Figure 4.10 Wedge Design A) Drawing Detail B) Photograph of Wedge .....	72
Figure 4.11 Plywood Laced Post As-Built Drawing .....	74
Figure 4.12 Photographs of Constructed PLP Shores in Test Frame A) 5ft Clear Span PLP B) 4ft Clear Span PLP.....	75
Figure 4.13 Photographs of Cupping Wedges A) Initial Cupping Under Smaller Loads B) Extreme Cupping Under High Loads.....	76
Figure 4.14 Fabrication of LP Photographs A) Layout of Main Elements B) Layout of Braces C) Using the First Side as a Guide for the Assembly of the Second Side.....	80
Figure 4.15 Fabrication of LP Photographs A) Assembly of Third Side B) Rolling the Shore C) Fully Assembled LP Shore .....	81

Figure 4.16 Design Detail for Laced Post Shore .....	82
Figure 4.17 Fabrication of PLP Photographs A) Toe-nail Posts B) Double Gusset Plate C) Install Interior Half-Gusset Plates.....	85
Figure 4.18 Completed PLP Shores A) 4ft and 5ft Clear Space PLP B) Side View of a 5ft Clear Space PLP .....	86
Figure 4.19 Design Detail for Plywood Laced Post Shore .....	87
Figure 5.1 Typical Vertical Load-Displacement Plot.....	90
Figure 5.2 Test 1 Wedge Performance A) Right Side Cupping B) No cupping at Front Left C) Minor Cupping of Back Right.....	92
Figure 5.3 Load-Displacement Curve for Specimen 1 .....	93
Figure 5.4 Test 1 A) First Failure and Bowing of Posts B) All Post Failures .....	93
Figure 5.5 Final Failed Condition at the End of Test 1 .....	94
Figure 5.6 Post Failures A) Back-Left B) Back-Right C) Front-Left D) Front-Right.....	94
Figure 5.7 Connection Failures A) Pull Through B) Pullout C) Post Splintering D) Half-Gusset Rotation and Pull Through .....	95
Figure 5.8 Test Specimen 2 Wedge Cupping .....	96
Figure 5.9 Load-Displacement Curve for Specimen 2 .....	97
Figure 5.10 Specimen 2 A) Left Post Buckling B) First Failure .....	98
Figure 5.11 Specimen 2 A) Second Failure B) Third Failure C) End of Test Condition.....	98
Figure 5.12 Post Failures A) Back Left B) Back Right C) Front Left.....	99
Figure 5.13 Samples of Minor Pullout from Specimen 2 .....	100

Figure 5.14 Specimen 3 Wedge Photos A) Cupping at Approx. 60 kips B) Back Right Wedge at End of Test C) Front Left Wedge Cupping and Post Bearing .....	101
Figure 5.15 Specimen 3 A) Bowing of Right Posts before Failure B) End of Test Condition C) Close-up of All Four Post Failures .....	102
Figure 5.16 Load-Displacement Curve for Specimen 3 .....	103
Figure 5.17 Post Failures A) Back Left B) Back Right C) Front Left D) Front Right.....	103
Figure 5.18 Photographs of the Five Brace Connection Failures at End of Test.....	104
Figure 5.19 Connection Failure Photographs A) Nail Pullout from Split Brace B) Nail Pullout from Post .....	105
Figure 5.20 Specimen 4 Wedges A) Wedges at Failure B) Back-left Wedge Cupping.....	106
Figure 5.21 Load-Displacement Curve for Specimen 4 .....	107
Figure 5.22 Specimen 4 Failure Photographs at Conclusion of Test.....	107
Figure 5.23 Post Failures A) Back-Left B) Back-Right C) Front-Left D) Front-Right.....	108
Figure 5.24 Locations of Connection Failures on Specimen 4.....	109
Figure 5.25 Specimen 4 Connection Failures A) Nail Pullout B) Nail Pullout Holes C) Partial Pullout on Left Side.....	109
Figure 5.26 Photographs of Wedges at the End of Test .....	111
Figure 5.27 Specimen 5 Displacement Phases A) 2in Left B) 2in Right C) 4in Left D) 4in Right .....	112
Figure 5.28 Horizontal Load-Displacement Plot with 32kip Vertical Load.....	113
Figure 5.29 Horizontal Load-Displacement Plot with 48kip Vertical Load.....	113



Figure 5.30 Comparison of Horizontal Load-Displacement Cycles for each Vertical Load .....	114
Figure 5.32 Load-Displacement Curve for Specimen 5 .....	115
Figure 5.31 Specimen 5 Failure Progression A) Bowing of Posts B) Back Posts Fail C) Front Posts Fail D) Final Condition at End of Test .....	115
Figure 5.33 Post Failures A) Back-Left B) Back-Right C) Front-Left D) Front-Right.....	116
Figure 5.34 Connection Failure Examples from Specimen 5 .....	117
Figure 5.35 Condition of Wedges after Loading .....	118
Figure 5.36 Loading Specimen 6 A) Initial 6in Displacement Prior to Loading B) 1 <sup>st</sup> Connection Failure C) Back Right Post Failure.....	119
Figure 5.37 Load-Displacement Curve for Specimen 6 .....	120
Figure 5.38 Specimen 6 Failure Sequence A) 1 <sup>st</sup> Failure B) Front Right Failure C) Front Left Failure .....	120
Figure 5.39 Detailed Photographs of each Post Failure A) Back Left B) Back Right C) Front Left D) Front Right.....	121
Figure 5.40 Brace Failure Locations.....	122
Figure 5.41 Wedge Cupping and Bearing Under Posts During Loading .....	123
Figure 5.42 Load-Displacement Curve for Specimen 7 .....	124
Figure 5.43 Failure Modes A) Initial Failures B) 3 <sup>rd</sup> Failure C) 4 <sup>th</sup> Failure .....	125
Figure 5.44 Failure Photographs A) Front-Right Post B) Back-Right Post C1) Top Failure of Front-Left Post C2) Bottom Failure of Front-Left Post D) Back-Left Post .....	126
Figure 5.45 Regions of Significant Brace Connection Failures .....	127

Figure 5.46 Photograph of Wedges at 15in Displacement .....	128
Figure 5.47 Vertical Load-Displacement Curve for Specimen 8 .....	129
Figure 5.48 Horizontal Load-Displacement Curve for Specimen 8 .....	130
Figure 5.49 Progression of Lateral Displacement with Applied 32kip Load .....	131
Figure 5.50 Photographs of Right Side Post Failures .....	131
Figure 5.51 Connection Failures of Braces.....	132
Figure 5.52 Photograph of 1 <sup>st</sup> Level Front Right Joint .....	133
Figure 5.53 Photographs of Wedges A) Left Side B) Right Side.....	134
Figure 5.54 Vertical Load-Displacement Curve for Specimen 9 .....	135
Figure 5.55 Horizontal Load-Displacement Curve for Specimen 9 .....	135
Figure 5.56 Progression of Lateral Displacement with Applied 32kip Load .....	136
Figure 5.57 Post Failure Locations A) Initial Failure During Lateral Displacement B) Final Shore Condition .....	137
Figure 5.58 Individual Post Failures A) Back Left Post B) Back Right Post C) Front Left Post .....	138
Figure 5.59 Photographs of Brace Connection Failures .....	138
Figure 5.60 Wedge Performance A) Shore Base at Failure B) Back Right Wedge .....	140
Figure 5.61 Loading Sequence A) Initial State B) 2in Cycles C) 4in Cycles.....	140
Figure 5.62 Load-Displacement Curve for Specimen 10 .....	141
Figure 5.63 Comparison of Horizontal Load-Displacement Cycles for each Vertical Load .....	141
Figure 5.64 Post Failures A) Initial Failures B) Secondary Failure C) Final State .....	142

Figure 5.65 Failure Close-ups A) Back Left Post B) Back Right Post C) Front Left Post D) Front Right Post .....	143
Figure 5.66 Diagonal Brace Connection Failures .....	144
Figure 5.67 Status of the Wedges at Failure .....	145
Figure 5.68 Loading Sequence A) Initial State B) 2in Cycles C) 4in Cycles.....	146
Figure 5.69 Comparison of Horizontal Load-Displacement Cycles for each Vertical Load .....	146
Figure 5.70 Load-Displacement Curve for Specimen 11 .....	147
Figure 5.71 Failure Sequence A) 1 <sup>st</sup> Failure B) 2 <sup>nd</sup> Failure C) Final Failures .....	148
Figure 5.72 Failures A) Back Left Post B) Back Right Post C) Front Left Post D1) Front Right (Front) D2) Front Right (Back) .....	148
Figure 5.73 Brace Connection Failures .....	149
Figure 5.74 Wedge Performance A) Left Side B) Right Side .....	150
Figure 5.75 Load-Displacement Curve for Specimen 12 .....	151
Figure 5.77 Failures A) 1 <sup>st</sup> Failure B) 2 <sup>nd</sup> Failure C) Excessive Torsional Buckling of Braces, Excessive Deflection D) Final Failure of Left Posts .....	152
Figure 5.76 Progressive Failure of Specimen 12 .....	152
Figure 5.78 Brace Connection Failures .....	153
Figure 5.79 Bearing Into Left Header A) Front Left B) Back Left C) Front Left (Interior) .....	154
Figure 5.80 Wedge Performance with 72kip Load A) Right Side at 0.0hrs B) Left Side at 0.0hrs C) Left Side at 8.0hrs .....	155
Figure 5.81 Load-Displacement Curve for Specimen 13 .....	156

Figure 5.82 Progressive Failures A) 72kips B) 1 <sup>st</sup> Failure C) Front Left and Back Right Posts Fail D) Back Left Post Fails (End of Test).....	157
Figure 5.83 Post Failures A) Back Left B) Back Right C) Front Left D) Front Right.....	158
Figure 5.84 Brace Failures A) 1 <sup>st</sup> Level Brace on Right Side B) Top Plate on Right Side C) Gusset Plates on Right Side D) Gusset Plates on Left Side.....	159
Figure 5.85 Condition of the Headers A) Split Left Header (foreground) and Split Right Header (background) B) Bearing of Left Front Post into Left Header .....	160
Figure 6.1 Lateral Displacement versus Peak Capacity.....	166
Figure 6.2 Vertical Deformation Comparison of PLP Shore Specimens .....	169
Figure 6.3 Peak Capacity versus Misalignment.....	171
Figure 6.4 Vertical Deformation at Peak Capacity.....	177
Figure 6.5 LP Controlling Single Shear Yield Modes (NDS 2005) .....	178
Figure 6.6 Example of Yield Mode IV from Specimen 8.....	178
Figure 6.7 PLP Controlling Single Shear Yield Mode (NDS 2005).....	179
Figure 6.8 Example of Yield Mode III <sub>s</sub> from Specimen 1 .....	180

# **CHAPTER 1**

## **Introduction**

This thesis is a presentation of the results of an experimental investigation of wood shoring systems for use by Urban Search and Rescue (US&R) teams to stabilize buildings damaged by earthquakes, fires, wind, terrorist attacks or other extreme loadings. This chapter provides some background for this investigation, describes the research objectives, and outlines the scope of this thesis.

### **1.1 US&R WOOD SHORING BACKGROUND**

The Federal Emergency Management Agency (FEMA) US&R specialists utilize many variations of shoring systems in emergency situations. In these situations, emergency shoring systems are defined as “the temporary stabilization or re-support of any structural element that is physically damaged, missing or structurally compromised by a partial or total collapse of the structure, resulting in the danger of the structure’s collapse” (O’Connell, 2006). The stability of a structure may become compromised due to natural or man-made hazards, and may require temporary shoring for the safety of trapped building occupants, and for search and rescue personnel. The U.S. Army Corps of Engineers (USACE) US&R Field Operations Guide (FOG) includes construction specifications for over nine different styles of emergency shoring designed to support vertical (gravity) load scenarios (USACE FOG 2009). These include three different classes of shores each with increasing complexity and increasing capacity and stability. This investigation will focus on two different configurations of Class 3 rescue shoring identified in the FOG: laced post (LP) and plywood laced post (PLP) shores.

Prior testing conducted by FEMA on these shores has focused on “ideal” vertical concentric loading of these two types of shores and has experimented with multiple design configurations (FEMA StS2 Summary - Testing of Laced Post & Plywood Laced Posts, 2011). However, non-ideal loading scenarios such as lateral loads and eccentric

loads have not been investigated. This has left a gap in the knowledge of the behavior of these shoring systems when subjected to lateral forces due to for example, earthquakes aftershocks, wind, or building stability loads, and to eccentric vertical loading conditions.

Prior testing conducted by FEMA has typically included the measured load capacity of the shores, but has not generally included additional measurements such as vertical and lateral deflection of the shores during loading. As a result, previous test data has not allowed characterization of important structural response measures such as stiffness and ductility. These additional measures can be useful in assessing the performance of shores under non-ideal conditions.

## **1.2 RESEARCH OBJECTIVES**

### **1.2.1 Shore Capacity under Non-Ideal Loading Scenarios**

The primary objective of this investigation was to evaluate, by testing, the structural performance of LP and PLP shores under several non-ideal loading scenarios that were identified to be of interest by US&R shoring specialists. These loading scenarios are described below. Additional objectives were to identify, where possible, critical limits on the performance of shore, and to suggest design modifications and improvements, if warranted.

### **1.2.2 Evaluate Performance under Combined Vertical and Lateral Loading**

As described earlier, previous tests on LP and PLP shores included measurements of their load capacity under concentric vertical loads (load centered on shore) intended to represent gravity loading on the shore. An issue of concern identified by US&R specialists was the behavior of the shore under combined vertical and lateral loads. Of particular interest was the question: to what degree is the vertical load capacity of the shore reduced due to lateral forces or displacements of the shore? Both monotonic and cyclic lateral loads are of interest. Cyclic lateral loading can occur, for example, due to an earthquake aftershock. Near monotonic lateral loads can occur, for example, due to a

wind gust or due to second-order frame effects.

### **1.2.3 Evaluate Performance under Load-Control versus Displacement Control Tests**

Previous tests on shores were typically conducted using a load-control system of applying forces to the shores. Load-control can be achieved by applying dead weight at the top of the shore (normally concrete blocks) and then adding additional weight until failure of the shore. The load is never reduced during the testing process, and failure of the shore tends to be rapid, as the shore is crushed under the applied weights. An alternative approach to testing is to use displacement-control. With this approach, vertical downward displacements are applied at the top of the shore, typically using hydraulic loading rams. The load required to apply the displacement is measured, and displacement is increased until the peak vertical resistance of the shore is achieved. Once the peak resistance is achieved, additional vertical displacement can continue to be applied, and the post-peak load capacity of the shore can be measured.

Both load-control and displacement-control laboratory testing offer some advantages and disadvantages. Load-control may be more representative of the type of loading the shore will see in actual service. However, with load-controlled laboratory tests, it is not possible to measure the vertical load-deflection response after the shore reaches its peak vertical capacity (i.e. after the shore fails). This, in turn, means that it is not possible to assess the ductility of the shore under vertical load; and ductility is an important response quantity that helps assess the safety of shores under overload conditions. Displacement-controlled testing may be less representative of the actual loading the shore may see in service. However, displacement-controlled testing provides more information on the performance of the shore under overload conditions, and as noted above, allows an assessment of the ductility of the shore. Further, displacement-control testing is generally safer in the laboratory.

A key question of interest in this research program was to determine if the peak load capacity measured for a shore is different for load-control testing versus

displacement-control testing. If the peak vertical load capacities are about the same for either method of testing, then it would be possible to use displacement-control not only to assess the peak capacity of a shore, but also to quantify the behavior after the peak capacity is achieved.

#### **1.2.4 Identify Design Weaknesses and Recommend Improvements**

An additional objective of this testing program was to identify possible design flaws or areas of concern in both LP and PLP shore configurations. A further objective was to suggest possible improvements in the shore designs that might provide higher load capacities and greater ductility and safety of the shores.

#### **1.2.5 Evaluate Emergency Fuses**

Emergency shoring systems are designed to provide safe and reliable support, but also to provide early warning signs of distress. These early warning signs are provided by design features of the shores known as “fuses.” Fuses are visual or audible signals that alert trained emergency personnel that a specific shoring tower may be getting close to failure. Examples of these signs of distress, as discussed in greater detail later, are cupping of the wedges, cracking of headers or soles, and cracking/creaking sounds of the wood members. In the event that a shore is being loaded beyond design levels and may be in danger of failure, these fuses must be sufficiently obvious as to alert rescuers. Accordingly, an objective of this research is to evaluate the effectiveness and consistency of these fuses during all tests, and suggest possible improvements.

#### **1.2.6 Compare LP and PLP Designs**

An additional objective of this investigation was to compare the performance of the LP shores versus the PLP shores and to evaluate which one of these provides better structural performance.



### 1.3 PROJECT OVERVIEW AND SCOPE OF THESIS

Testing of the shores was conducted at the Ferguson Structural Engineering Laboratory of The University of Texas in Austin, Texas, between July and December 2011. Research was sponsored by the Stabilization of Buildings Program of the Department of Homeland Security, and was conducted in collaboration with Protection Engineering Consultants (PEC). Significant support, advice and assistance was provided by two experts from the FEMA US&R Structural Specialist (StS) group:

- David J. Hammond: Lead instructor for the FEMA/USACE US&R Structural Specialist (StS) training program, member of California's US&R Task Force 3 (CATF3), former Chair of the Department of Homeland Security DHS/FEMA US&R Structures Subgroup.
- John O'Connell: Task Group Chair for the Structural Collapse Section, former Task Force Leader for New York City's US&R Task Force 1 (NY-TF1), lead instructor for the DHS/FEMA Rescue Specialist Training, Rescue Team Manager for Indiana's US&R Task Force 1 (IN-TF1).

Nine initial test specimens were constructed under the supervision of John O'Connell in July, 2011 and were tested between August and October 2011. Specimens were designed according the USACE FOG specifications as well as design details agreed upon by representatives of PEC, David Hammond, John O'Connell and researchers at FSEL. Details included species of wood, spacing of braces in the PLP shores and general shore dimensions. A test matrix was also decided upon with the representatives listed above to fulfill the research objectives. This test matrix is described in detail in Chapter 4.

Four additional specimens were subsequently constructed and were tested from November to December 2011. These specimens were included to provide additional

cyclic loading data as well as rapid and sustained loading data.

Chapter 2 of this thesis provides additional background on US&R shore systems. A complete description of the experimental setup is presented in Chapter 3 and details of the specimen design and loading scenarios are included in Chapter 4. The results of the tests are described in Chapter 5 followed by analysis and discussion of the test data in Chapter 6. Conclusions are presented in Chapter 7.

## **CHAPTER 2**

### **Background**

A discussion of background information pertaining to emergency wood shoring systems is provided in this chapter. The chapter begins with a brief review of key properties of wood, particularly as they pertain to this study. This is followed by a description of wood shoring systems used by FEMA US&R teams, including a description of fuses used in these shores. Next, calculations are presented to estimate the vertical capacity of the shores. The chapter concludes with a summary of previous testing of US&R shores.

#### **2.1 MATERIAL PROPERTIES OF WOOD**

Before presenting the design details and characteristics of emergency wood shoring towers, some basic concepts of wood for use in structural applications are reviewed.

##### **2.1.1 Classifications of Wood**

Wood is an organic material and its engineering properties are a function of its growth environment. The species of trees used for structural lumber are segregated into two classifications, softwoods and hardwoods. These classifications describe the type of tree rather than the hardness of the wood itself. Hardwoods represent broad-leafed deciduous trees and softwoods include cone-bearing trees commonly referred to as conifers. The majority of structural lumber is harvested from the softwood category (Forest Products Laboratory, USDA Forest Service, 2010). Along with the classification of hardwood or softwood, structural lumber is broken down by species or groups of species. One species group can include different tree varieties but will have one reference design value in the NDS tables. There are often subsets to these species groups which have their own unique material properties and therefore particular reference design values. These subsets often represent the environmental variable in the material

properties of wood, such as the region from which the tree was harvested.

### **2.1.2 Cellular Structure of Wood**

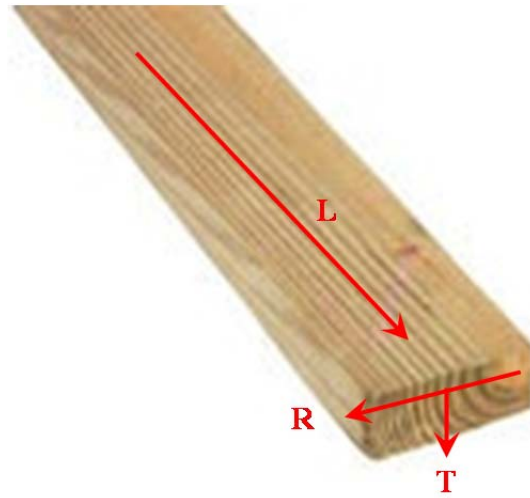
The strength of wood is greatest in the vertical growing direction of the tree. This strength is primarily associated with the cellular makeup of the different cell wall layers within a tree. These walls are formed by groupings of cellulose chains called microfibrils. In particular, wood's longitudinal strength is derived from the  $S_2$  layer in which the microfibrils align closely with the longitudinal direction providing the tree with the majority of the required strength and stiffness to grow (Forest Products Laboratory, USDA Forest Service, 2010).

The  $S_1$  and  $S_3$  layers are smaller in thickness and contain microfibrils oriented in mostly the radial or tangential directions with very little order in the structure. These fibers slightly provide the strength of wood in the radial and tangential directions. However compared to the  $S_2$  layer, these thin, unorganized layers do not provide considerable strength, thus we see much larger wood resistance values in the longitudinal direction than any other (see *Section 2.1.5*).

### **2.1.3 Wood as an Orthotropic Material**

As briefly highlighted above, wood is a unique, orthotropic building material with distinctively different properties in the longitudinal (L), radial (R), and tangential (T) directions (Goodman & Bodig, 1970). As such, at a point it has twelve elastic constants, nine of which are independent. These include a modulus of elasticity in each of the three directions, a shear modulus in the LR, RT, and TL planes, as six Poisson's ratios, two in each plane. The longitudinal axis correlates to the direction of the upward growth of the tree and is considered parallel to the grain. The radial axis extends from the pith (center of the rings) of the tree outward perpendicular to the rings and perpendicular to the longitudinal axis. The tangential axis is mutually perpendicular to the longitudinal and radial axes and tangentially intersects the annual rings at any point. Both the radial and tangential axes are considered perpendicular to the grain. Figure 2.1 presents a typical

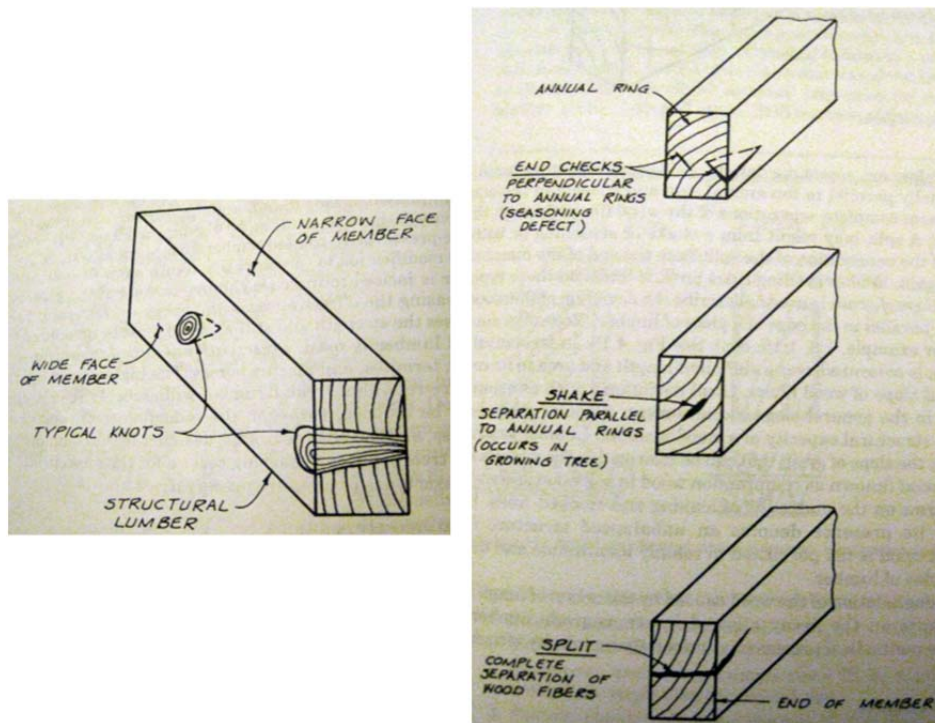
2x4 cross section with the directional axes labeled.



**Figure 2.1** Longitudinal (L), Radial (R) and Tangential (T) Directional Axes

#### **2.1.4 Impact of the Visual Grading System**

The fact that most lumber is visually graded is one of the most important aspects of understanding wood as a building material. After lumber is milled, boards typically run down a conveyor belt where trained individuals specify the quality of the wood for each board. These individuals assign a grade to each piece of lumber based upon “established limits on the size and number of growth (strength-reducing) characteristics that are permitted” (Breyer, Fridley, Cobeen, & Pollock, 2007). These “growth (strength-reducing) characteristics” are imperfections typically characterized by knots, checks, shakes, and splits (see Figure 2.2).



**Figure 2.2** Common Types of Growth Imperfections

*(Breyer, Fridley, Cobeen, & Pollock, 2007)*

Visual grades in descending order of quality are: Dense Select Structural, Select Structural, No.1 Dense, No.1, No.2 Dense, No.2, No. 3 and other very low grades of lumber typically used for miscellaneous purposes.

However, it is important to understand that the system of grading lumber is an imperfect system. Though the graders are trained individuals, they must assign a grade to a piece of lumber based upon an inspection lasting only a few seconds, and typically after seeing only one face of the board. Therefore it is possible for a specific board with a No.1 grade stamp to exhibit the material properties of a No.3 board, and vice versa (Forest Products Laboratory, USDA Forest Service, 2010). Also, due to the organic nature of wood, no two pieces of lumber, even from the same tree, will behave identically nor possess the exact properties as those listed in the NDS Reference Design Tables (Forest Products Laboratory, USDA Forest Service, 2010). Thus, the properties of wood

are very difficult to accurately predict.

In addition, once the wood has been cut, graded and distributed, factors such as moisture content and temperature can directly impact the material properties of board. Wood exposed to high temperatures (+150°F) can experience significant reductions in strength, on the order of 30 percent (NDS 2005). These effects are also magnified by moisture content. A wood member with high moisture content will have less strength at elevated temperatures, and is also more susceptible to creep (NDS 2005).

### 2.1.5 Design Properties

Consistent with its growth characteristics, a wood member is typically strongest in the longitudinal direction for both compression and tension. A comparison of design values for wood in tension parallel to grain ( $F_t$ ), compression parallel to grain ( $F_c$ ), and compression perpendicular to grain ( $F_{c\perp}$ ) found in Reference Design Tables 4A and 4B in the National Design Specifications (NDS) for Wood Construction reflect this directional strength for any species of wood ( American Forest & Paper Association; American Wood Council, 2005). Figure 2.3 provides a portion of these NDS design tables, where it can be seen that design values  $F_t$  and  $F_c$  are considerably larger than  $F_{c\perp}$ .

Species and commercial grade	Size classification	Design values in pounds per square inch (psi)				
		Bending $F_b$	Tension parallel to grain $F_t$	Shear parallel to grain $F_v$	Compression perpendicular to grain $F_{c\perp}$	Compression parallel to grain $F_c$
<b>SOUTHERN PINE</b>						
Dense Select Structural	2" - 4" wide	3,050	1,650	175	660	2,250
Select Structural		2,850	1,600	175	565	2,100
Non-Dense Select Structural		2,650	1,350	175	480	1,950
No.1 Dense		2,000	1,100	175	660	2,000
No.1		1,850	1,050	175	565	1,850
No.1 Non-Dense		1,700	900	175	480	1,700
No.2 Dense		1,700	875	175	660	1,850
No.2		1,500	825	175	565	1,650
No.2 Non-Dense		1,350	775	175	480	1,600
No.3 and Stud		850	475	175	565	975
Construction Standard	4" wide	1,100	625	175	565	1,800
Utility		625	350	175	565	1,500
		300	175	175	565	975

**Figure 2.3** Table 4B Reference Values for Southern Yellow Pine (NDS 2005)

### **2.1.6 Environmental Factors**

Environmental factors such as local climate, soil conditions, geography, and exposure conditions can all impact the growth and therefore properties of a particular tree. Longer growing periods, represented by the earlywood (light color region between rings), often result in a less dense material. In contrast, a tree with shorter growing cycles will have a cross-section comprised of a higher percentage of latewood (slower growing dark wood) resulting in a generally more dense material. When lumber is visually graded, graders often look at the amount of growth rings per inch to determine if a particular board is considered “dense” (Example: Douglas-Fir-Larch No. 1 Dense).

### **2.1.7 Loading Rate of Wood**

Wood is also sensitive to the rate at which loads are applied. Research conducted by the Forest products Laboratory showed that a simply supported wood beam could support higher loads if the loads were applied for a shorter period of time (Forest Products Laboratory, USDA, 1951). This empirical data lead to strength level equations which provided the strength of wood as a percentage of the standard five minute test strength.

The NDS specifications also used this information to create load duration factors ( $C_D$ ) for Allowable Strength Design (ASD) of wood members. Load durations factors are applied to all design calculations for wood members in accordance with NDS 2005 Table 2.3.2. These values are greater than 1.0 (strength increase factor) for loads applied over a short period of time, and are less than 1.0 (reduction factor) for sustained loads. For Load Resistance Factor Design (LRFD), load rate effects are implemented using a time effect factor ( $\lambda$ ) which is larger for load combinations with a greater short term load component. For impact loading, this value is 1.25, a strength increasing factor. Thus it can be predicted that a higher rate of loading should produce higher capacities.

## **2.2 DEFINING EMERGENCY SHORING**

Shoring systems have been used for centuries for an array of project types and

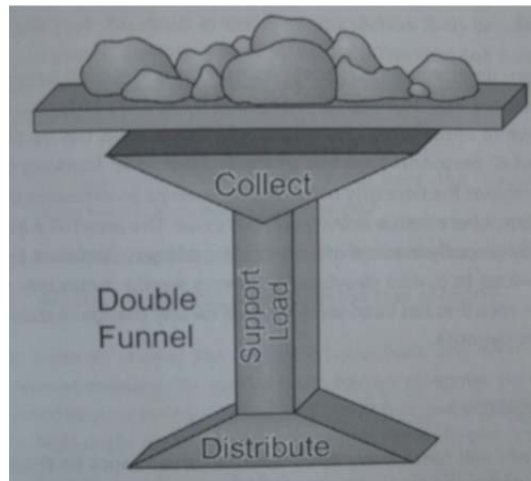


purposes. Today, shoring systems are primarily used in construction to stabilize unfinished structures or support a structure during modifications.

The Federal Emergency Management Agency (FEMA) Urban Search & Rescue (US&R) specialists utilize many variations of shoring systems in emergency situations. In these situations, emergency shoring systems are defined as, “the temporary stabilization or re-support of any structural element that is physically damaged, missing or structurally compromised by a partial or total collapse of the structure, resulting in the danger of the structure’s collapse” (O’Connell, 2006). The stability of a structure may become compromised due to natural or man-made hazards, each of which creates a unique scenario for trained emergency responders to negotiate. The US&R Structures Subgroup has developed standard designs and practices for both vertical and lateral shoring systems to encompass a range of emergency situations and structural configurations. These standards are specified in the U.S. Army Corps of Engineers (USACE) US&R Field Operations Guide (FOG), and were strictly followed during the fabrication of shore specimens for this research investigation. Choosing the correct materials and properly constructing each emergency shore is essential to providing a relatively safe environment for rescuers and victims alike. Shoring systems are designed to offer safe, reliable and temporary support, while maintaining relatively predictable behavior of the damaged structure. Shores can also be used to provide early warning signs of distress. These early warning signs, known as fuses, are visual or audible signals of distress such as cupping of the wedges, cracking of headers or soles, or cracking/creaking of the wood members. Emergency wood shoring fuses will be discussed in greater detail in *Section 2.4*.

A shoring system is based upon the double funnel principle in which loads from a damaged region are collected, transferred through the shore, and redistributed to the ground or other suitable structural element (Structural Collapse Technician Course - Student Manual, 2010). This process, shown in Figure 2.4, is only possible if four major components are provided. Each shore system must include a header or top plate in which

to collect loads from the region above, posts or struts to support and transfer the load, and a bottom or sole plate to redistribute the load into the foundation or other portions of the structure. The fourth element is a system of lateral or diagonal braces which prevent buckling of the posts or struts. The configuration and performance of this fourth component is the focus of this research investigation.

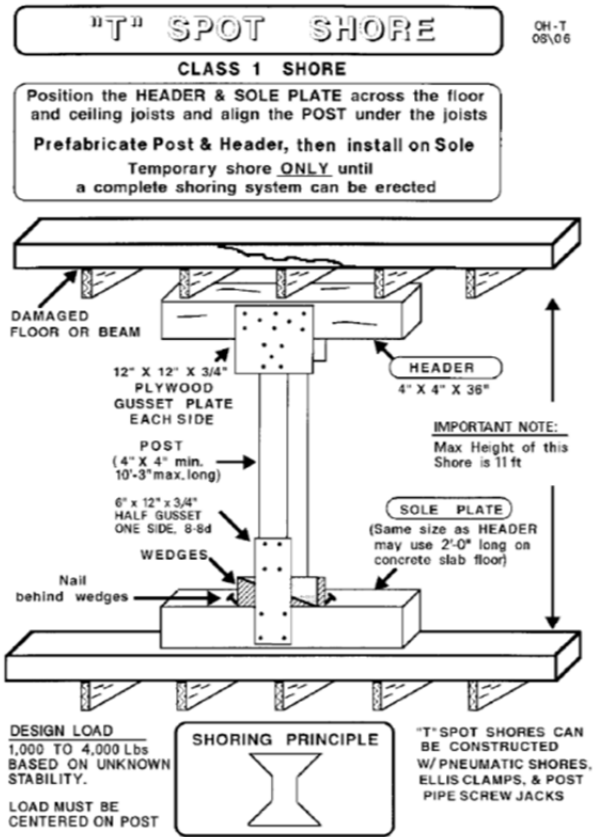


**Figure 2.4** Conceptual Diagram of the Double Funnel Principle (*O'Connell, 2006*)

### **2.3 TYPES OF US&R SHORES**

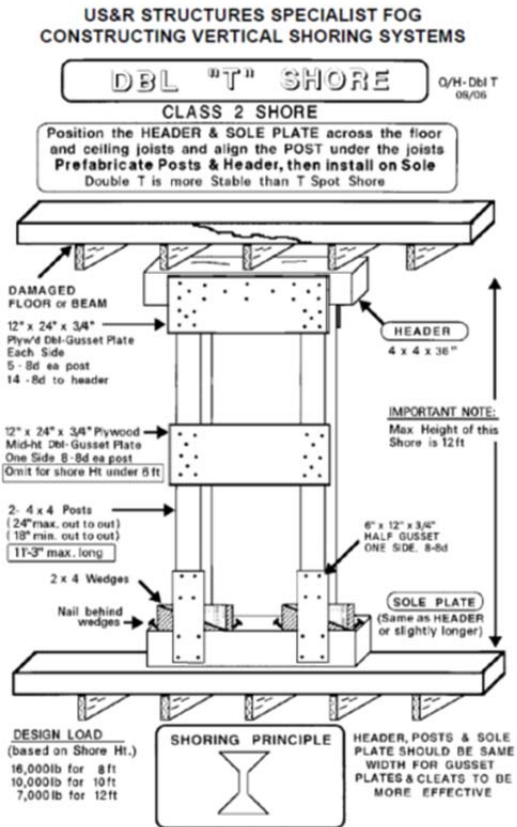
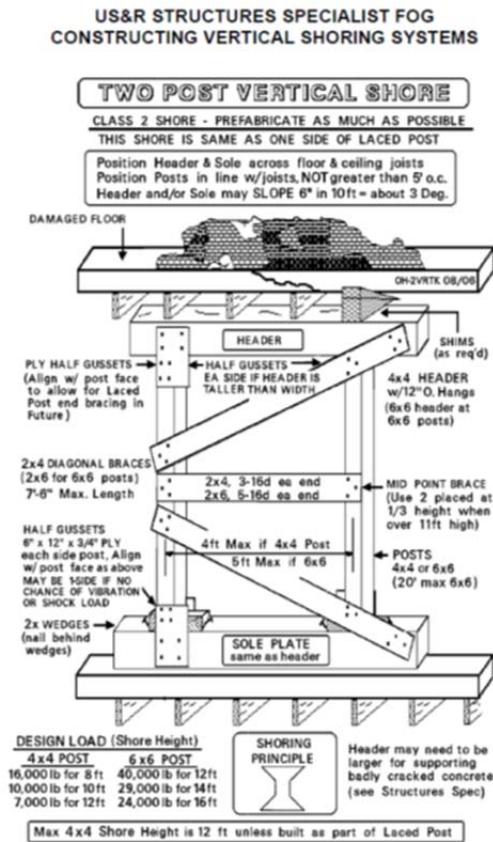
The USACE US&R Field Operations Guide (FOG) includes over nine different styles of emergency shoring designed to support vertical (gravity) loading scenarios. These include three different classes of shores each with increasing complexity, capacity, and stability.

Class 1 shores are 1-dimensional shores solely used as temporary spot shores that can be rapidly fabricated and installed to provide a level of immediate support while a Class 2 shore is constructed and installed. Figure 2.5 presents a typical Class 1 vertical shore.



**Figure 2.5** Standard Class 1 Shore (*USACE FOG 2009*)

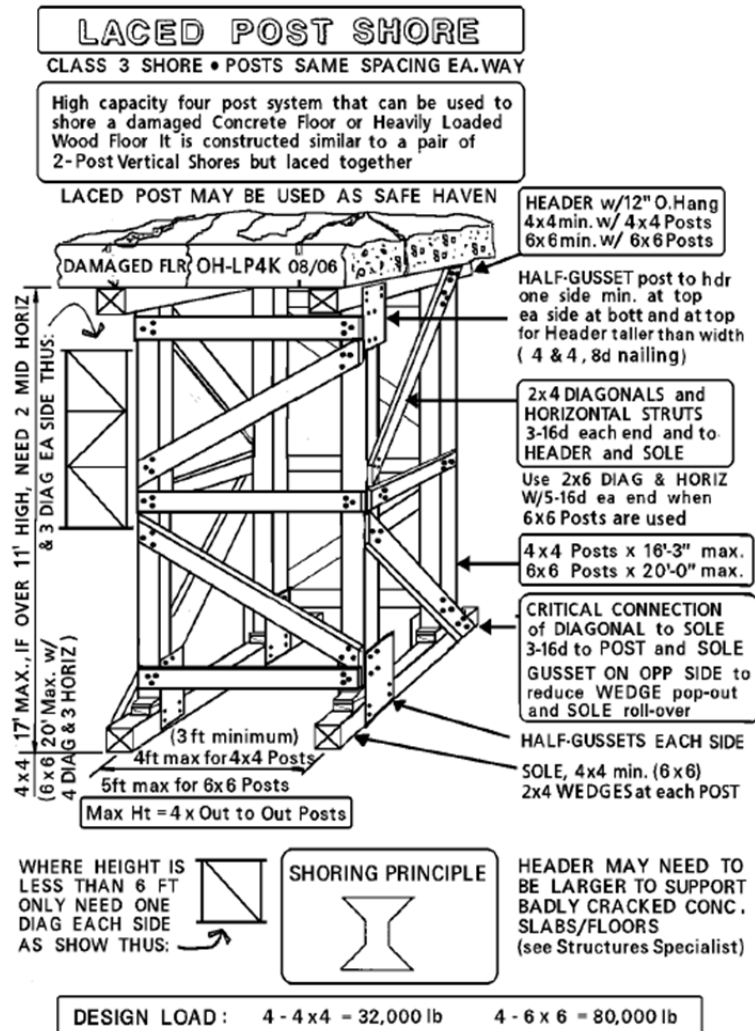
Class 2 shores (2-dimensional) provide an additional level of support beyond that of the Class 1 shore. The use of two posts and lateral braces increases the capacity and stability of the shore. Figure 2.6 presents an example of a Class 2 shore.



**Figure 2.6** Laced Post Class 2 Shore (Left) and Plywood Laced Post Class 2 Shore (Right), (*USACE FOG 2009*)

In many applications, a Class 2 shore is not adequate and is used as a temporary spot shore (like the Class 1) while a Class 3 (3-dimensional) shore is constructed and installed. Often the installed Class 2 shore is converted into a Class 3 shore by completing the three additional sides or linking two adjacent shores together with braces. The Class 3 shore not only provides more vertical load carrying capacity than the Class 1 and Class 2 shores, but also provides additional stability and can be built to a maximum height of 20ft (see Figure 2.7).

**US&R STRUCTURES SPECIALIST FOG  
CONSTRUCTING VERTICAL SHORING SYSTEMS**



**Figure 2.7** Standard Laced Post Class 3 Shore (*USACE FOG 2009*)

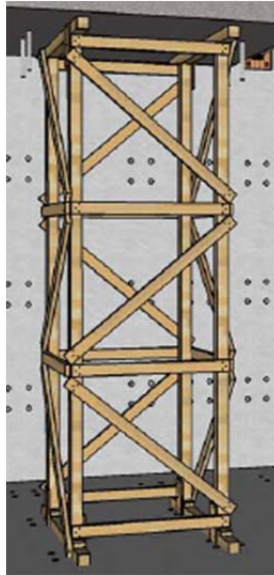
This additional capacity and stability make the Class 3 shore a frequently relied upon emergency shoring system. Therefore, a design that produces both an appreciable vertical load carrying capacity and high level of lateral stability is desired.

The design of the Class 3 shore (known as a laced post shore) is based upon a wood tower-like structure composed of 4x4 posts, headers and soles stabilized by a series

of laced bracing. The research conducted and presented herein, investigated this laced post style of vertical shore with two different bracing configurations. The two styles of bracing are presented in the following subsections.

### 2.3.1 Standard Laced Post Shore

The standard laced post (LP) shore utilizes 2x4 lumber braces in a “reverse K” configuration using diagonal and horizontal braces to transfer loads, similar to that of a truss (see Figure 2.8 below).



**Figure 2.8** Computer Generated Model of a Laced Post Shore

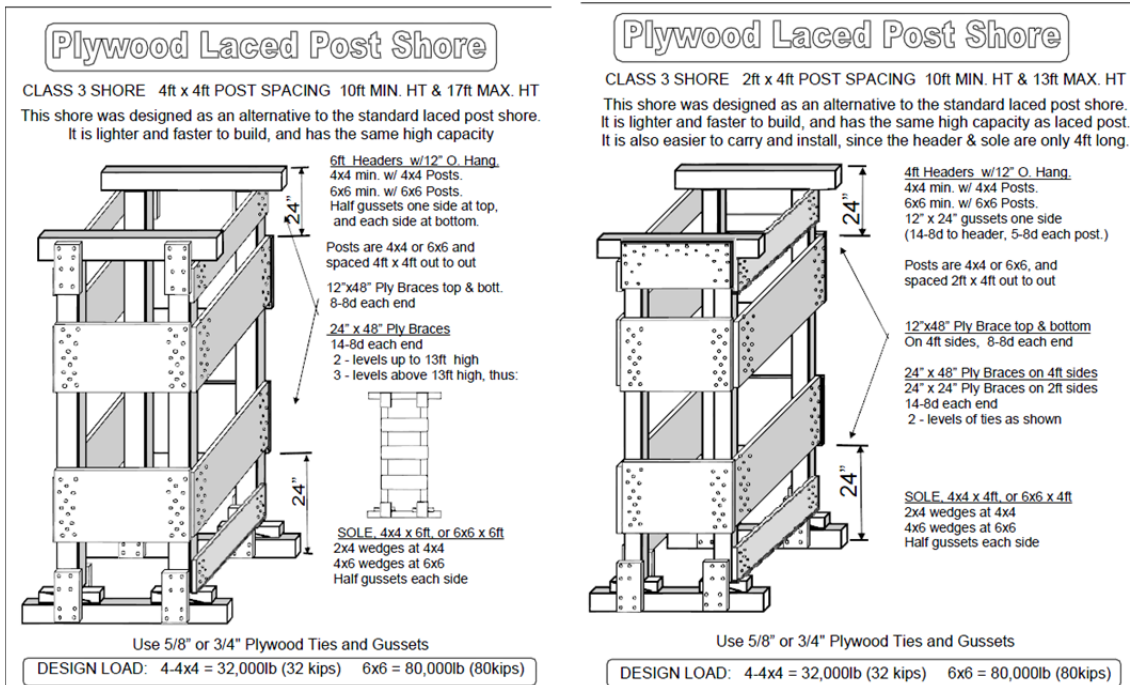
As shown in the US&R FOG specification in Figure 2.7, the design of a LP shore is dependent on the desired height of the shore. The four posts, two headers and two soles can be constructed using 4x4 or 6x6 dimensional lumber, increasing the footprint and overall height respectively. As the height of the shore increases, more bays (spaces between 2x4 horizontal braces) must be added for stability. The “reverse K” configuration of the 2x4 braces creates an ‘X’ when looking from the side of each bay in the tower. In practice, the shore is securely fit between the floor above and the floor or

ground below using wedges between each post and sole. The wedges also serve as a warning fuse, and typically cup (ends rise in a ‘U’ shape) under high loads. A more detailed design description for laced post shores is included in *Chapter 4*.

This 2x4 “reverse K” bracing configuration was the standard design for a laced post (Class 3) emergency shore in the FOG 2009, and has been used in practice for years. There are benefits to this style of bracing, but a few shortcomings. The 2x4 dimensional lumber is a common cut of lumber and is easily accessible, which is important in an emergency situation. Braces are easy to cut and the “reverse K” allows for a high level of visibility through the cross-section of the shore, which is essential for the safety of emergency personnel. However, the number of braces required to fabricate a standard LP are numerous and the dimensional length of the diagonal braces are different for different shore heights - thus requiring more time to build. Also, larger nails are required to fasten 2x4 braces to the 4x4 posts, as is discussed in *Section 2.6.1*, which are often more difficult to successfully drive due to their longer length and larger diameter.

### **2.3.2 Plywood Laced Post Shore**

Starting in the mid-2000s, US&R shoring experts including John O’Connell and David Hammond began investigating the performance of plywood braced laced post shores. These plywood laced post (PLP) shores utilize plywood plates to brace the four 4x4 posts (Figure 2.9). An official PLP design was not included in the USACE US&R Field Operations Guide (FOG), until the 2011 edition.



**Figure 2.9** Plywood Laced Post Shore Specifications, 4ft x 4ft Base (Left), 2ft x 4ft Base (Right), (USACE FOG 2011)

The purpose of this new system of bracing was to create a stronger and more efficient laced post shore. As shown in Figure 2.9 above, the PLP shore is similar in design to the LP shore. Posts, headers and soles are constructed with 4x4 dimensional lumber, and wedges are still used for installation. However, no 2x4 dimensional lumber is used in the PLP shore. All braces are constructed with plywood and each style of brace is a typical size, regardless of shore height. Like the LP, the PLP shore with 4x4 posts can be built to a height of 17ft, but can be built with a smaller footprint of 2ft x 4ft in addition to the standard 4ft x 4ft footprint.

The PLP design also enhances efficiency and usability of the shoring system. Plywood is as readily available as 2x4 dimensional lumber, but the reduced number of braces allows for faster fabrication. Also, each type of plywood brace is a standard size,

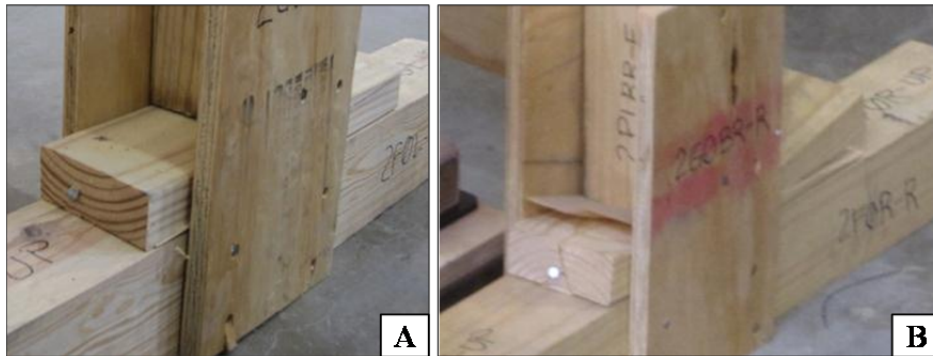
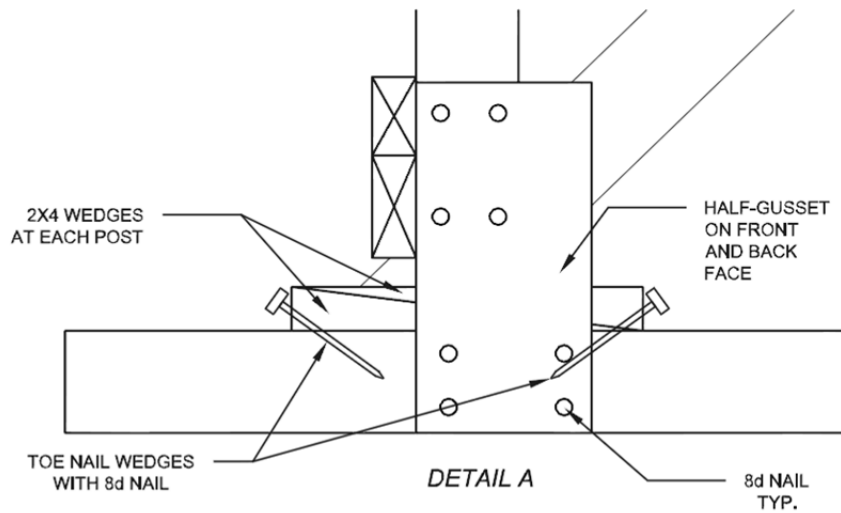


rather than unique to the diagonal distance created by shores of different heights. This allows emergency shoring teams to produce many braces at once, which can be used for any sized PLP shore. The challenge in this design was to create a shore with adequate capacity while maintaining manageable brace sizes and visibility through the cross-section of the shore. The performance of previously tested PLP towers will be discussed in *Section 2.7*.

#### **2.4 FUSES: EARLY OVERLOAD DETECTION**

Emergency shoring systems are designed not only to provide safe and reliable support, but to also provide early warning signs of distress. These early warning signs, known as fuses, are visual or audible signals that alert trained emergency personnel that a specific shoring tower has become overloaded. Examples of these signs of distress are cupping of the wedges, cracking of headers or soles, and cracking/creaking sounds of the wood members.

Beneath each post in a laced post system are a set of 2x4 wedges. These wedges are specifically designed to create a tight fit for the shore between the floors above and below. However, as loads on the shore increase, these wedges can be seen bending upwards (cupping) under the bearing load of the post. This is a very noticeable sign of overload and typically the more extreme the cupping, the higher the load on the shore. Figure 2.10 presents the design of the wedges and provides an example of a wedge cupping under high vertical loads.



**Figure 2.10** Wedge Design Details and Photographs A) Installed Wedge with No Load B) Installed Wedge Cupping Under Load

Another visual fuse is the splitting and cracking of headers or soles (4x4 members on top or bottom) due to bearing loads. As the posts resist the applied load, the bearing stress applied perpendicular to the grain of the 4x4 header/sole can cause the fibers to split under internal tensile loads. These forces cause the fibrous layers of the 4x4 member to separate and crack. This can be simulated by a bundle of plastic straws. A compressive force applied about an internal section causes the ends of the straws to separate, thus the fibers at the ends of the members separate. Figure 2.11 shows an example of header splitting during previous testing conducted by US&R.



**Figure 2.11** Split Header Due to Overload, (*FEMA StS2 Summary- Testing of Laced Post & Plywood Laced Posts, 2011*)

In addition to visual means of distress detection, audible cracking and creaking sounds can alert trained rescuers to shore overload. These sounds can originate from a variety of sources on the wood shore, including the locations where the posts bear on the 4x4 headers and soles; same as the splitting fuse discussed above. As the wood fibers start to yield and separate, energy is released causing an audible response. Other sources of cracking/creaking sounds are joints where two or more members are joined using nails. As the load increases, individual members start to deform and shift, causing the connections to move and realign. The bearing forces created by the nails into the wood members produce audible responses much like the headers/soles. Friction forces between the member faces can also cause an audible response.

Wedge cupping, splitting of headers and audible cracking sounds are the three typical fuses used by US&R personnel to detect overloaded shores. If an overloaded shore is found, additional shores are typically constructed and installed in the same vicinity to relieve the original tower.

## **2.5 SHORE DESIGN CAPACITY**

Each individual wood shore class and configuration has a specific design capacity for which the shore is rated. These design capacities are calculated based upon the material properties and material strengths of the individual wood components, and specified in the US&R specifications. Typically, the controlling nominal strength value is associated with the compression perpendicular to grain (cross grain) forces caused by the bearing of the post into the header/sole. For the commonly utilized species of lumber, Douglas fir-larch and southern yellow pine, the US&R specified design value is 8,000lbs (8.0kips) per 4x4 post (Structural Collapse Technician Course - Student Manual, 2010). A LP or PLP shore has four posts, thus the total design capacity is 32,000lbs (32.0kips). Calculations to investigate this design load are shown in Appendix A using the material properties for southern yellow pine and Douglas fir-larch, and summarized below. All calculations were conducted using LRFD design factors to calculate the ultimate design capacities of the shores.

### **2.5.1 Summary of Bearing Capacity Design Calculations**

The bearing capacities of southern yellow pine No. 1 dense and standard No. 1 were calculated in accordance with the NDS 2005. Southern yellow pine No. 1 dense was calculated to have a design capacity of 9,096lbs per post for a total design carrying capacity of 36.4kips. Southern yellow pine No. 1 was calculated to have a design capacity of 7,786lbs per post for a total design carrying capacity of 31.1kips. Finally, Douglas fir-larch No. 1 was calculated to have a design capacity of 8,613lbs per post for a total design carrying capacity of 34.4kips. These calculations did not directly equate to the 32-kip design load but support a design load of 32kips as reasonable and even conservative in the case of dense southern yellow pine No. 1 and standard Douglas fir-larch No. 1.

### **2.5.2 Buckling Capacity Design Calculations**

The US&R specifies that the compression perpendicular to the grain is the

controlling design consideration, rather than buckling of the columns. For purposes of comparison, the buckling capacity (compression parallel to grain) for a southern yellow pine post of similar size to the specimens used was calculated in Appendix A. The vertical span between horizontal braces was used in the calculations as the effective buckling length. For a 13-ft tower, the longest length of a column between equally spaced braces is 52in. and this length was taken as the effective buckling length. From Appendix A, the buckling capacity of a southern yellow pine No. 1 post section is 92.8kips.

### **2.5.3 Buckling versus Bearing Design Loads**

It can be seen that the design loads for bearing are more critical than for buckling of the posts between braces by nearly a factor of three. Also, the 32-kips design capacity is very representative of the design bearing capacities of shores made from either southern yellow pine No. 1 or Douglas fir-larch No. 1. Empirical data further discussed in *Section 2.7* also supports the adequacy of 32.0kips as a design shore capacity.

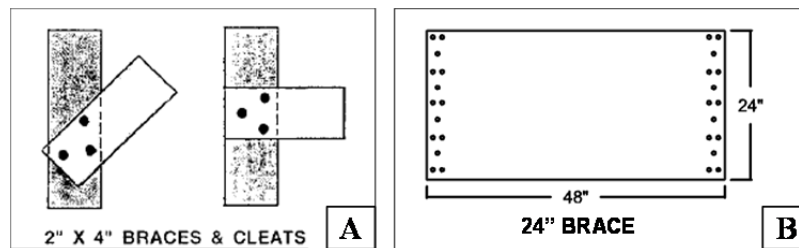
## **2.6 CONNECTION PROPERTIES AND CAPACITIES**

In addition to the design capacities of the individual wood members, the capacities of the connections are also important to the overall performance of the shore. The USACE FOG details for both LP and PLP shores specify the types and sizes of nails used in the connections. Nails are considered the primary type of fasteners for their availability and the speed at which they can be driven using a pneumatic nail gun. For the LP shores, all dimensional lumber connections (2x4 to 4x4) are to be connected using 16d sinker nails, or 12d common nails. For all plywood connections, 8d common nails are to be used. The PLP tower utilizes only plywood braces, therefore only 8d common nails are used in fabrication.

Two theoretical types of fastener failure mechanisms exist for the design configuration of the LP and PLP shores. The nails can either pull straight out (withdrawal failure) or fail in shear. An alternative failure mechanism involves the

yielding of the wood where the nails “tear-out” of the brace. This style of failure will not be calculated because observations from previous research showed that the nails either bent or pulled-out prior to any tear-out failure.

There are multiple patterns of nail connections for each type of shore; however this section will only focus on the typical patterns used for the intermediate brace connections on both the LP and PLP shore respectively. The 2x4 braces on the LP shore were fastened using three nails in a triangular pattern, while the typical 24in plywood brace was connected using 14 nails in an alternating 2-1-2 pattern on each end. These patterns are shown below.



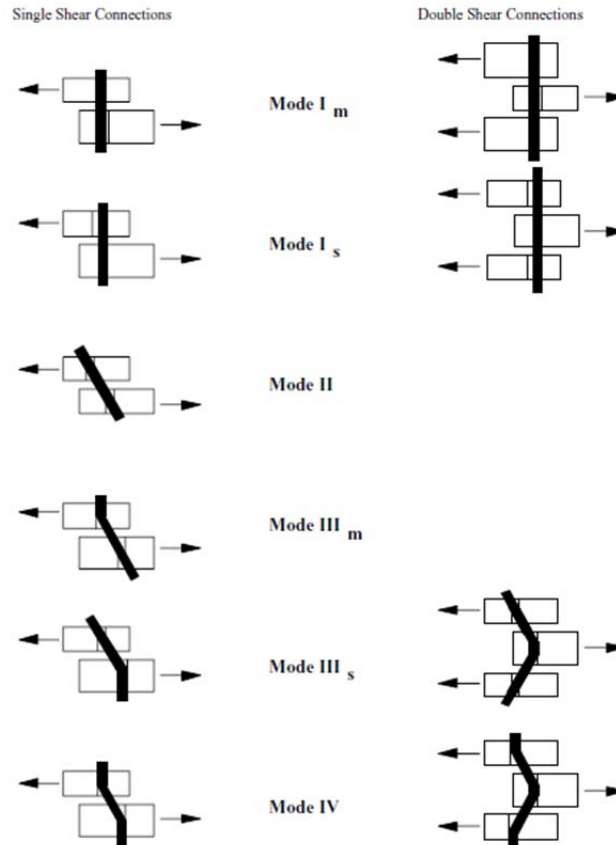
**Figure 2.12** Brace Nailing Patterns A) 2x4 Connection B) 24in Plywood Brace Connection

### 2.6.1 2x4 Brace Connection: 3 Nails

Capacities of the nailed connections were calculated using the properties for 12d common nails and southern yellow pine lumber which are representative of the materials used to fabricate the LP shores in this investigation. At the connection, the 2x4 brace is considered the side member, while the 4x4 post is considered the main member since the end of the nail resides within the 4x4. All calculations are provided in Appendix A and were calculated using the values and equations retrieved from the 2005 NDS.

When a fastener connects two adjacent members, the single plane of contact produces shear forces in the fastener, thus this type of shear is deemed single shear. Note that the design shear capacity requires the calculation of all six possible shear modes of

failure, where the smallest capacity controls. The theoretical controlling design mechanism calculated will be later compared to the actual observations from the different specimens. Diagrams of the six different yield modes are shown in Figure 2.13.



**Figure 2.13** Connection Yield Modes (*Figure II NDS 2005*)

From the calculation presented in Appendix A, the three nail connection used in the LP shore is controlled by yield mode IV with a total connection capacity of 0.50kips. This means that the nail will form two hinges and be bent in double curvature upon failure.

The withdrawal value ( $W'$ ) for a fastener is the force required to pull the fastener

out of the “main member” perpendicular to the wood fibers. This is not expected to control in the ideal truss action of the shore braces, but was noticed during testing. Withdrawal calculations were also conducted in Appendix A for the three nail connection using NDS 2005 specifications. The calculated withdrawal design capacity of this connection was 0.31kips.

Though withdrawal controls, this would require a force pulling perpendicular to the wood member, which is not as likely as parallel to the member. The expected axial force in a brace to induce shear yielding is 0.50kips. The actual forces developed in the brace members will be due to lateral load on the shore or due to stability induced forces (brace resisting buckling of the 4x4 posts). Although the connection capacity is rather low, it may still be adequate to allow the brace to restrain buckling of the posts. In this case, the low connection capacity would not limit the capacity of the shore under vertical load. Observations will be made during the tests to determine if this is the case. However, the low connection capacity may well be a limiting factor on the lateral load capacity of the shore. Again, observations will be made during the tests to determine if this is the case.

### **2.6.2 Plywood Brace Connection: 14 Nails**

The following capacities were calculated using the properties for 8d common nails and southern yellow pine lumber which are representative of the materials used to fabricate the PLP shores. At the connection, the plywood brace is considered the side member, while the 4x4 post is considered the main member since the end of the nail resides within the 4x4. All calculations are provided in Appendix A and were calculated using the values and equations retrieved from the 2005 NDS.

Similar to the 2x4 brace configurations, shear yielding and withdrawal of the nails are the two major connection failure mechanisms. Again, with two members in contact, each nail is subject to single shear, thus all of the equations used to calculate values in *Section 2.6.1* are valid.

From the calculation presented in Appendix A, the 14- nail connection used in the



PLP shore is controlled by yield mode III<sub>s</sub> with a total connection capacity of 1.30kips. This means that the nail will form one hinge and be bent in single curvature while bearing against and deforming the wood fibers of the side (plywood) member. Note that this design value is 2.6 times higher than the capacity of the 2x4 brace connection. This is primarily due to the number of nails used in the connection (14 versus 3). Also, a different yield mode controlled for the 8d nails on the PLP compared to the 12d nails on the LP. Therefore it is expected that the plywood brace connection may perform better than the 2x4 brace connection providing more lateral stability.

The withdrawal value ( $W'$ ) for a fastener is the force required to pull the fastener out of the “main member” perpendicular to the wood fibers. This is not expected to control in the ideal truss action of the shore braces, but was noticed during testing. Withdrawal calculations were also conducted in Appendix A for the 14-nail connection using NDS 2005 specifications. The calculated withdrawal design capacity of this connection was 1.40kips. Note that the withdrawal value for the LP 2x4 brace connection was 0.31kips, much less than the value for the shorter but more numerous 8d nail configuration. The shear yield mode for the plywood had a capacity of 1.30kips suggesting that shear failures of the connections should be more prevalent than pullout.

From the values presented above, it can be seen that the plywood braces have a higher connection capacity than that of the 2x4 LP braces. This added stability may result in higher overall capacities and better performances during lateral loading. The two different yield modes in shear will be compared to observed deformations in the nails and reported upon in *Chapter 6: Observations and Analysis*.

## **2.7 PREVIOUS TESTING BY US&R**

Numerous tests involving LP and PLP shores have been conducted as a result of previous research investigations and training seminars for US&R Structure Specialists. These tests provided the empirical data behind the design configuration of the current PLP specifications.

Between May 2001 and May 2010, FEMA US&R in coordination with USACE

conducted multiple series of tests including LP and PLP shores, which were documented in *StS-2 Training – Summary of Laced Post, Plywood Laced Post Testing*. The purpose of these tests was to investigate the capacities of the different style shores as well as assess the response of the emergency fuses. The performance of the newly developed PLP configurations were of particular interest. Details of the investigation and an outline of the results are included below. Three summary tables are presented in *Section 2.7.4*, which list the results from nine years of testing sorted by shore configuration.

### **2.7.1 FEMA StS-2 Training: Testing and Results - March 2001 - March 2005**

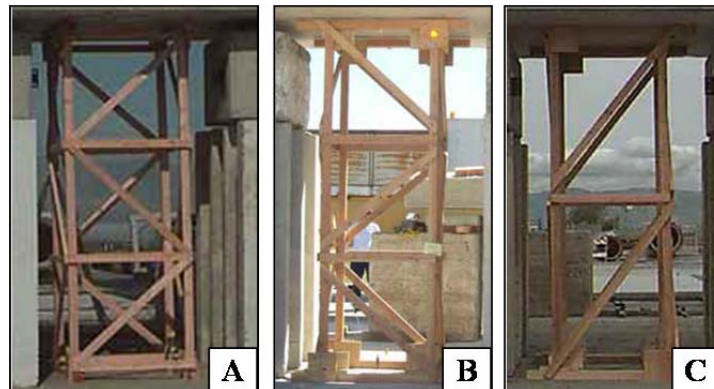
Initial tests were conducted at the NASA/AMES Outdoor Aeronautical Research Facility (OARF) at Moffett Field, California. From March 2001 – March 2005, three design configurations of LP specimens, 12.5ft in height, were vertically loaded using a concrete loading slab and concrete blocks of known weight, as shown in Figure 2.14.



**Figure 2.14** OARF Loading Apparatus (*FEMA StS2 Summary- Testing of Laced Post & Plywood Laced Posts, 2011*)

The design capacity of a laced post shore is specified as 32kips based upon the bearing capacity of the headers and soles. The concrete loading slab measured 38kips in weight (1.2 x the design capacity) and each additional concrete block measured 12.5kips, which were added in pairs (25kip increments). This exemplifies a load-controlled test since the amount of load applied is maintained between each increment and does not vary based upon the response of the structure. However, once the failure load is reached, this method of loading typically causes a dynamic and catastrophic failure due to the failure load being maintained.

The use of 25kip load increments limited the ability to determine the failure load within a 25kip incremental range, thus capacities were reported as a range of values. Each of the specimens tested during this period failed as the 3<sup>rd</sup> pair of blocks were added, so capacities could only be recorded as above 88kips and less than 113kips. An approximated failure capacity based upon in-situ observations was also estimated and recorded as the approximate failure load. The three laced post designs tested including the standard reverse K, standard K and two bay parallel diagonal shores (see Figure 2.15). A table of the test results and failure loads is presented in *Section 2.7.4*.



**Figure 2.15** Three LP Test Designs A) Reverse K B) Standard K C) Two Bay Parallel Diagonals (*FEMA StS2 Summary- Testing of Laced Post & Plywood Laced Posts, 2011*)

Summaries from each of the three series of tests yielded similar observations, as reported in *StS-2 Training – Summary of Laced Post, Plywood Laced Post Testing*. First, it was noted that significant cupping of the wedges was present at twice the working load of the shores (64kips). This is an important observation as it can be used to estimate the load on an active shore in an emergency situation simply by noting the amount of cupping in the wedges.

As expected from the material properties calculations in *Section 2.3*, cross grain crushing was observed “at loads much lower than those causing system failure.” However, crushing was typically observed at loads 1.5-2 times the design capacity (48kips-64kips) rather than around 32kips. This is also an important fuse observation, as significant audible cracking noises would be expected to correlate with the cross grain crushing.

The range of capacities for each specimen measured greater than 88kips, therefore it was concluded that the laced post system was adequate to loads of up to about three times the working design load (96kips) when loaded vertically. The failures were characterized as typically occurring at knots in the posts near the intersection of braces.

The March 2005 tests experimented with the use of 2x6 dimensional lumber as braces for a laced post shore with 4x4 posts. It was concluded that the larger braces did not improve the overall performance and capacity of the shore.

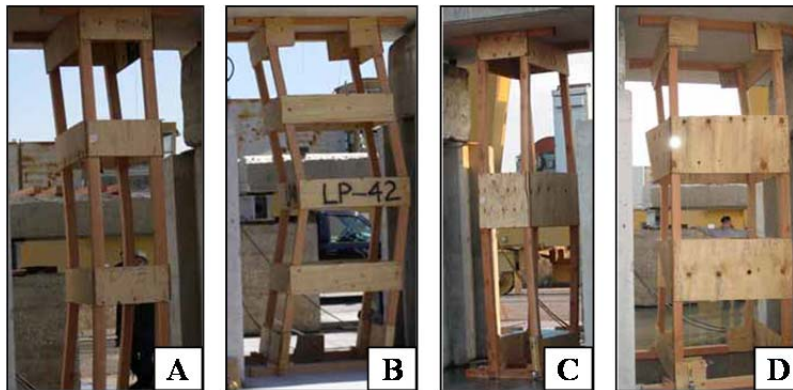
Overall, these tests provided a level of confidence that the laced post shore configuration could resist loads of over three times the design capacity of 32kips. Failure modes were also very consistent, and the emergency fuses (wedge cupping and audible sounds) proved effective.

### **2.7.2 FEMA StS-2 Training: Testing and Results - November 2005 - May 2006**

After successfully completing multiple tests on laced post shores, two series of tests were conducted to investigate the effectiveness of plywood as a lateral bracing system. A new loading apparatus was also utilized to provide a more accurate means of measuring the capacity of each specimen.

The new loading system used 4-100kip hydraulic rams to vertically lift the concrete slab and concrete block system preloaded to 138kips. Once the shoring tower was installed, the rams were slowly unloaded, increasing the load on the shore. This method allowed the researchers to accurately measure the amount of force in the rams and subtract that force from the overall 138-kip system, equaling the load resisted by the shore.

The first test, LP-31, involved a typical reverse-K laced post shore, providing a general baseline capacity for the laced post configuration. The remaining tests involved plywood braces varying in size and spacing. Also, PLP shores with 4ft x 4ft and 2ft x 4ft footprints were tested. Some of the configurations involved in the November 2005 - May 2006 tests are shown in Figure 2.16 below.



**Figure 2.16** Examples of PLP Designs Tested A) 2-12in Braces B) 3-12in Braces C) 1-24in Brace D) 2-24in Braces (*FEMA StS2 Summary- Testing of Laced Post & Plywood Laced Posts, 2011*)

Brace dimensions typically involved either 12in or 24in wide braces and were installed at varying spaces along the posts. The amount of intermediate braces was also a variable in the test specimen configuration (see Figure 2.16). As the amount of load increased on the plywood laced shores, lateral torsional buckling of the plywood braces was observed (see Figure 2.17).



**Figure 2.17** Lateral Torsional Buckling of Plywood Braces (*FEMA StS2 Summary- Testing of Laced Post & Plywood Laced Posts, 2011*)

Plywood sheets are strongest in the orientation of the grain on the outer plies (Forest Products Laboratory, USDA Forest Service, 2010). In bending, this strength comes from the increased moment of inertia of the outer plies that are oriented in the longitudinal direction. In axial loading, this is due to the larger number of plies oriented with the grain in the direction of loading (longitudinal) because wood is strongest when loaded parallel to the grain. Plywood orientation typically corresponds to the 8ft dimension of a 4ft x 8ft sheet of plywood; therefore all braces should be installed such that the direction of the grain is left to right in the direction of the brace between posts. PLP-32 was fabricated with the strong direction of the plywood braces oriented up and down, reducing its capacity to brace the posts. As seen in Figure 2.18, individual plies in the plywood brace buckled under the loading. PLP-32 failed at a lower load than similar configurations with their respective plywood braces oriented in the correct direction (see results tables in *Section 2.7.4*).

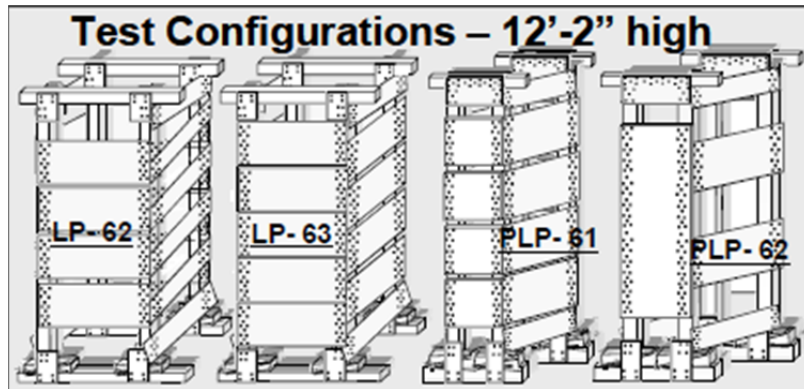


**Figure 2.18** Buckling of Individual Plies in Plywood Braces (*FEMA StS2 Summary- Testing of Laced Post & Plywood Laced Posts, 2011*)

After these two series of tests, it was determined that 12in. wide plywood braces did not provide adequate lateral bracing for laced post shores. Compared to the standard LP shores, the PLP shores with 12in. braces had a capacity on average of 17 to 37 percent less. Larger plywood braces would have to be used to provide more stiffness and support.

### **2.7.3 FEMA StS-2 Training: Testing and Results - May 2007 - May 2010**

The final three series of tests focused on adjusting the size and spacing of the plywood braces to find an optimal configuration. Both 4ft x 4ft footprints and 2ft x 4ft footprint shores were tested. Examples of a few of the configurations are shown in Figure 2.19.



**Figure 2.19** Examples of PLP Specimen Designs (*FEMA StS2 Summary- Testing of Laced Post & Plywood Laced Posts, 2011*)

The majority of the configurations utilized 24in. wide braces on all sides varying in quantity and spacing. Apart from specimen PLP-61, all PLP specimens in this series of tests failed at loads above 100kips.

#### **2.7.4 Summary of FEMA StS-2 Training Test Results**

Test results from all nine years of testing are presented in the following three tables, arranged by shore configuration.



**Table 2-1** Table of Results for Laced Post Shores (*Hammond, 2011*)

Table 1. LP Shore Tests (2 × 4 or 2 × 6 Lacing)					
Shore	Year	Tester	Lacing	Failure	Comments
LP-1	2001	OARF-1	2 × 4	100k	Failed at knots in posts
LP-2	2001	OARF-1	2 × 4	90k+	System failure because of inadequate bracing
LP-11	2004	OARF-1	2 × 4	90k+	Failed at knots in posts
LP-12	2004	OARF-1	2 × 4	90k+	Failed at knots in posts
LP-13	2004	OARF-1	2 × 4	NA	38k load, followed by lateral load test (1.2k max)
LP-21	2005	OARF-1	2 × 6	110k+	Best performance yet
LP-22	2005	OARF-1	2 × 6	90k+	Posts were split prior to test because of excess nailing from standard five 16d nails used for 2 × 6 lacing
LP-23	2005	OARF-1	2 × 6	NA	Pneumatic struts with 2 × 6 lacing. Two cycles of 2-inch lateral with 38k, then end test with no failure
LP-24	2005	OARF-1	2 × 4	100k+	Two cycles of 2-inch lateral with 38k, then vertical load to failure. Very good performance
LP-31	2005	OARF-2	2 × 4	103k	New loading system. Failed at knots in posts
LP-41	2006	OARF-2	2 × 4	103k	New loading system. Failed at knots in posts
LP-51	2007	280k-VT	2 × 4	100k	280k tester. Failed at knots in posts
LP-61	2008	280k-VT	2 × 4	103k	280k tester. Failed at knots in posts

Note: 1k = 1,000 lbs.  
 Except as noted, shores used 4 × 4-inch posts and 2 × 4 or 2 × 6 lacing.  
 Source: Table by author.

**Test findings.**

1. Except for LP-2, all specimens performed as a system with adequate bracing. LP-2 used only one midbrace per side instead of two, which is inadequate for this height.
2. LP systems supported three times the design load prior to failure.
3. Wedge cupping occurred 1.5 to 2.0 times the design load.
4. Header splitting occurred at about 2 times the design load.
5. Properly constructed FEMA LP shores should provide adequate warning of overload, allowing time for mitigation.
6. In most cases, the failures occurred at post knot locations near the intersection of the 2 × lacing with the posts.
7. Deflection (vertical compression of system) was normally less than a ½ inch at design load, and increased to between two and three inches just prior to failure. Most deflection resulted from crushing of the header and sole.

**Table 2-2** Table of Results for 4ft x 4ft Plywood Laced Post Shores (*Hammond, 2011*)

Table 2. PLP Shore Tests (4-foot× 4-foot Layout)					
Shore	Year	Tester	Lacing	Failure	Comment
LP-32	2005	OARF-2	2-24" plywood	103k	Failed at post knots, similar to 2 × diagonal tests
LP-42	2006	OARF-2	3-12" ply	83k	Failed in buckling, 12-inch plywood is inadequate
LP-52	2007	280k-VT	2-24" ply	100k	Failed at knots in posts, similar to 2 × diag. tests
LP-53	2007	280k-VT	2-24" ply	88k	Failed at knots in poorest quality posts
LP-62	2008	280k-VT	4-24" ply	115k	Failed at knots in posts. Very good performance
LP-63	2008	280k-VT	5-24" ply	144k	Plywood was too close = impractical

Note: 1k = 1,000 lbs.  
 Source: Table by author.

**Test findings.**

1. With one exception (LP-42), all systems failed at the post knot locations near the upper or lower edge of the plywood lacing. Except for LP-42, failure occurred in using 12-inch plywood lacing, indicating that the plywood was too narrow to adequately brace the posts.
2. These PLP systems supported three times the design load prior to failure.
3. Wedge cupping was observed from 1.5 to two times the design load.
4. Header splitting occurred at about two times the design load.
5. PLP shores with 4-foot× 4-foot post layout can be configured to perform as well as standard LP shores.

**Table 2-3** Table of Results for 2ft x 4ft Plywood Laced Post Shores (*Hammond, 2011*)

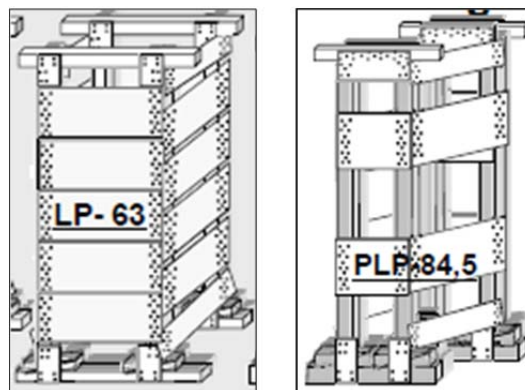
Table 3. PLP Shore Tests (2-foot × 4-foot Layout)					
Shore	Year	Tester	Lacing	Failure	Comment
PLP-31	2005	OARF-2	2-24" ply	88k	Buckling failure
PLP-32	2005	OARF-2	1-24" ply	88k	Buckling failure and re-test to 65k
PLP-41	2006	OARF-2	2-12" ply	65k	Buckling failure and post failure, 12" plywood not good.
PLP-42	2006	OARF-2	3-12" ply	67k	Buckling failure and post failure, 12" plywood not good.
PLP-51	2007	280k-VT	2-24" ply	90k	Failed at poor post with big knot
PLP-61	2008	280k-VT	4-24" ply	85k	Failed at poor post at big knot
PLP-62	2008	280k-VT	1-96" ply	115k	Very good test. Do additional tests
PLP-71, 72	2009	280k-VT	1-96" ply	125k+	5/8" plywood, very good test
PLP-73, 74, 81	2009	280k-VT	1-96" Ply	105k+	1/2" plywood, very good test
PLP-75	2009	280k-VT	1-96" ply	115k	3/4" oriented strand board (OSB), very good test
PLP-76	2009	280k-VT	48"+24"	115k	3/4" ply, (48" + 24", no 96") very good test
PLP-82, 83	2010	280k-VT	48"+24"	115k+	PLP-82=5/8"ply, PLP-83=1/2" ply
PLP-84, 85	2010	280k-VT	2-24" ply	120k+	5/8"ply, spaced near top and bottom of posts

Note: 1k = 1,000 lbs. Source: Table by author.

**Test findings.**

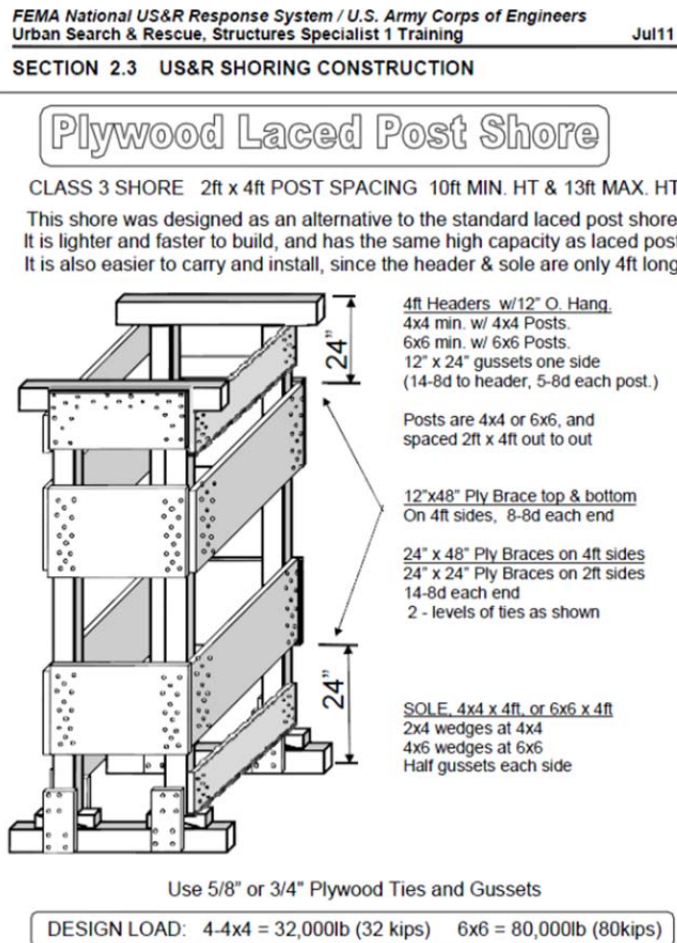
1. The 2-foot× 4-foot PLP, up to 13 feet high, can be configured to perform as well as the standard LP and the 4-foot × 4-foot PLP.
2. The PLP system can support three times the design load prior to failure.
3. Cupping of the wedges can be observed from 1.5 to two times the design load.
4. Splitting of the headers can be observed at about two times the design load.
5. Deflection was normally less than ½-inch at design load, and increased to between two and 3½ inches just prior to failure. Most of the deflection resulted from the crushing of the header and sole. Deflection increased significantly for loading above 100k, since the headers and soles become crushed to nearly one-half their original height.
6. PLP shores will be proposed as a new FEMA shore.

As seen above, many specimens carried loads above 100kips. In particular, LP-63 supported the largest vertical load of 144kips, but as seen in Figure 2.20, the spacing and quantity of plywood braces was impractical. Therefore, a compromise between workability and capacity was reached, and PLP-84,85 became the intended proposed design for the new standard plywood laced post shore.



**Figure 2.20** Highest Capacity (LP-63), Proposed Standard PLP Design (PLP-84,85)

PLP-84, a 2ft x 4ft dimensional tower, utilized 24in. wide, 5/8in. thick plywood braces on all four sides with 12in. top and bottom plates. The spacing between intermediate braces was specified as 3ft. This configuration was determined to be appropriate for both 2ft x 4ft base shores as well as 4ft x 4ft shores. Later, the intermediate spacing specification was changed from 3ft to 5ft based on further investigations after May 2010. Figure 2.21 presents the newly added specification to the USACE FOG 2011, which was used in the design of the PLP shores built for this investigation.



**Figure 2.21** Standard 2ft x 4ft Plywood Laced Post Shore (*USACE FOG 2011*)

Testing procedures and equipment used at the Ferguson Structural Engineering Laboratory to conduct the research presented herein are discussed in detail in *Chapter 3*. The specific designs and details of the shoring specimens used are presented in *Chapter 4*.

## **CHAPTER 3**

### **Experimental Setup**

This chapter describes the design and details of the experimental setup used for testing of the wood shores. In particular, the loading requirements, loading apparatus design and instrumentation used are presented. Additional design drawings of the experimental setup are included in Appendix B.

#### **3.1 LOADING REQUIREMENTS**

Design for the experimental setup was based upon the different types of loading scenarios requested by US&R and through discussions with the project team. The loading apparatus had to accommodate both vertical and lateral loading, as discussed below.

##### **3.1.1 Vertical Loading**

The loading system was designed to apply vertical loading on the shores using both load control and displacement control. Load control consists of incrementing the applied load until failure occurs without reducing the load on the shore. This method of loading represents the behavior of a structure under gravity loads, and is therefore likely most representative of the actual in-service loading condition. The disadvantage to load control is the limited opportunity to study the behavior of the shore after the first failure. Since the load on the shore is held constant or increased, failure is often sudden and catastrophic.

Displacement control utilizes small increments of displacement and records the force required to achieve such displacements. Once a failure occurs, the force applied to the shore is reduced to the remaining resistance of the shore. This enables the observation of the behavior of the shore after first failure.

Shores were tested under vertical loading as a means to establish a vertical capacity and a load-displacement curve for each type of shore. Load control was



compared with displacement control to determine if the peak vertical capacity is different for these two types of load application.

### **3.1.2 Lateral Loading**

As discussed in the *Chapter 2: Background Study*, US&R has performed multiple vertical loading tests prior to this study but had little data on the behavior of shores under lateral loading. Thus, in addition to vertical loading of the shores, the loading apparatus had to be capable of providing either a lateral displacement or a lateral force to the shoring tower. The ability to provide cyclic lateral loads was also needed.

### **3.1.3 Loading Interface**

During emergency situations, the shoring towers are normally in contact with concrete slabs at both the top and bottom of the shore. Therefore, it was desired that the testing apparatus provide a comparable loading interface such as a floor slab or grade beam to transfer load into the shore.

### **3.1.4 Tilt versus Level Loading**

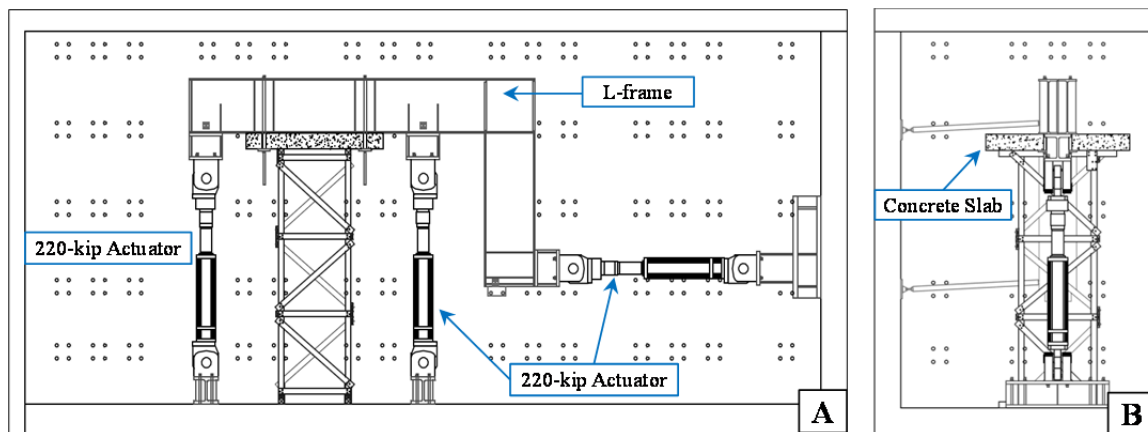
When the stability of a floor system is compromised, it can be prone to various types of movement. Depending on the layout and damage to the structural system in a building, the slab could potentially translate and rotate about various axes. Capturing all of these potential types of motion was not viable given the constraints of testing program and safety concerns. It was decided to apply both vertical and lateral loads in manner that the slab at the top of the shore remained approximately level (i.e. no rotation), and could translate vertically and in one horizontal direction. While this does not capture all possible deformation modes of the slab, this loading was within the capabilities of the laboratory equipment, and was believed to provide a reasonable simulation of some realistic loading conditions.

### 3.2 LOADING SYSTEM

Details and designs pertaining to the shore loading system are presented below. Included are the individual components of the loading apparatus, safety features, and limitations.

#### 3.2.1 Loading Frame and Actuators

The loading frame consisted of a steel L-frame used in combination with a concrete slab to simulate a floor slab. The L-frame is comprised of two wide flange sections welded together and stiffened using multiple full-length and half-length web stiffeners. To accommodate the loading requirements, the loading frame was connected to two vertical MTS hydraulic actuators and one horizontal MTS hydraulic actuator as shown in Figure 3.1.



**Figure 3.1** Loading Frame A) Front (Plan) View B) Side View

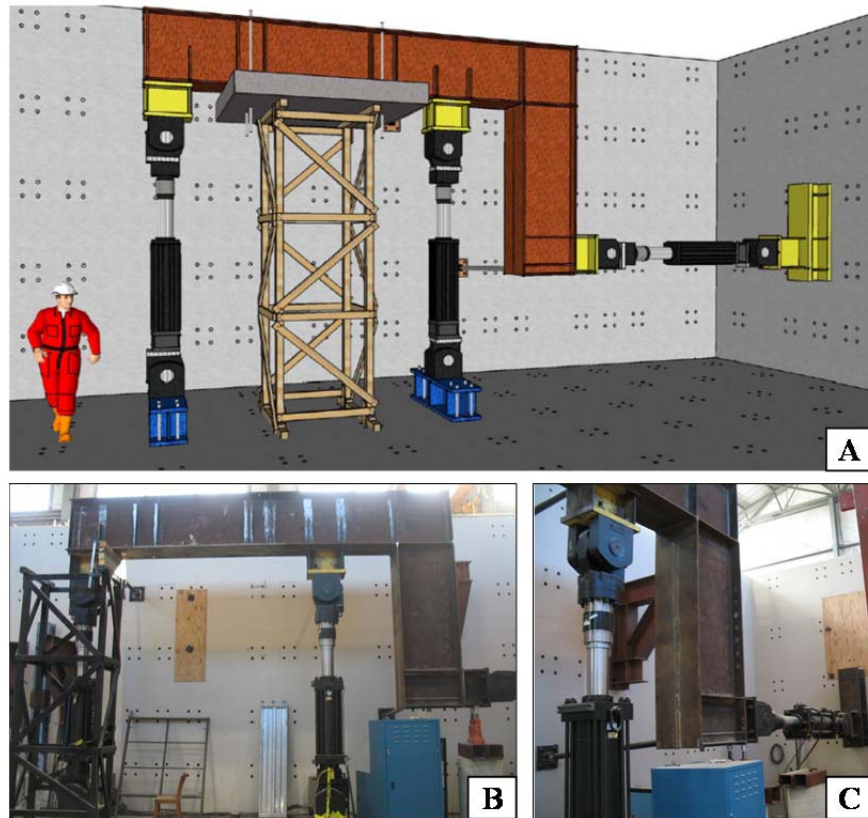
The loading system was designed so that the line of action of the horizontal actuator was approximately at mid-height of the shore. Further, the loading system was designed to prevent rotation at the top and bottom of the shore. Thus, in a simplified representation, the shore can be viewed as a fixed-fixed beam-column, with end translation possible under lateral load. A shore would be expected to see this type of loading in an actual building when sideways movement occurs of one floor level with

respect to another. This can occur under lateral wind or earthquake loading, or do to frame instability.

Each hydraulic actuator had a capacity of 220 kips and a stroke of 30 inches. All three actuators were controlled by an MTS “FlexTest” multi-channel controller interfaced with a PC. Specialized software was developed to interface with the MTS controller to achieve the various loading scenarios desired for this project. This included the ability to apply vertical load under load control or displacement control, and to apply simultaneous vertical and lateral load.

The vertical hydraulic actuators were anchored to a thick concrete strong floor, and the horizontal hydraulic actuator to a concrete reaction wall. The two vertical actuators could be controlled in unison to maintain a level loading head on the shore. The horizontal actuator was used to move the L-frame left and right (in the plane of the page in Figure 3.1-A) in either a cyclic or monotonic motion. During lateral loading, a programmed control loop was used on the two vertical actuators to keep the L-frame level while the horizontal actuator displaced the entire frame. A 3D interpretation of the loading frame is shown below along with actual laboratory photographs.





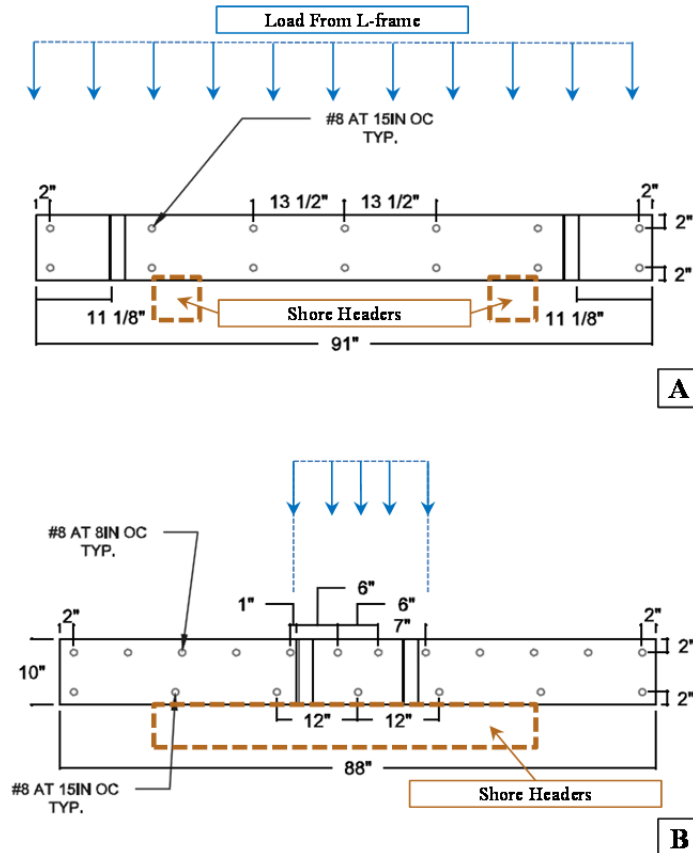
**Figure 3.2** Loading Frame A) Computer Generated Model of Loading Frame B) Photograph of Frame C) Photograph of Horizontal Actuator

### 3.2.2 Concrete Slab Design

The purpose of the concrete slab at the top of the shore was to evenly load the shore as would be expected by a floor slab in an actual building. However, deflection of the slab during testing was not desirable because it would provide an inaccurate data reading of the overall displacement by the MTS actuator displacement transducers. The slab was also expected to endure the loading of multiple shores without cracking or failure. Therefore the slab was designed to provide high stiffness and high strength to endure multiple tests.

To provide adequate strength and stiffness, 10ksi concrete was used to cast the slab and a top and bottom mat of reinforcement was used. The longitudinal bars in the

top mat perpendicular to the shore headers were considered to be the critical reinforcing elements. A reinforcement ratio of 1.0% was used for these bars, and a ratio of 0.5% used for the transverse steel in the top mat and in both direction of the bottom mat. Reinforcement details are shown below in Figure 3.3.



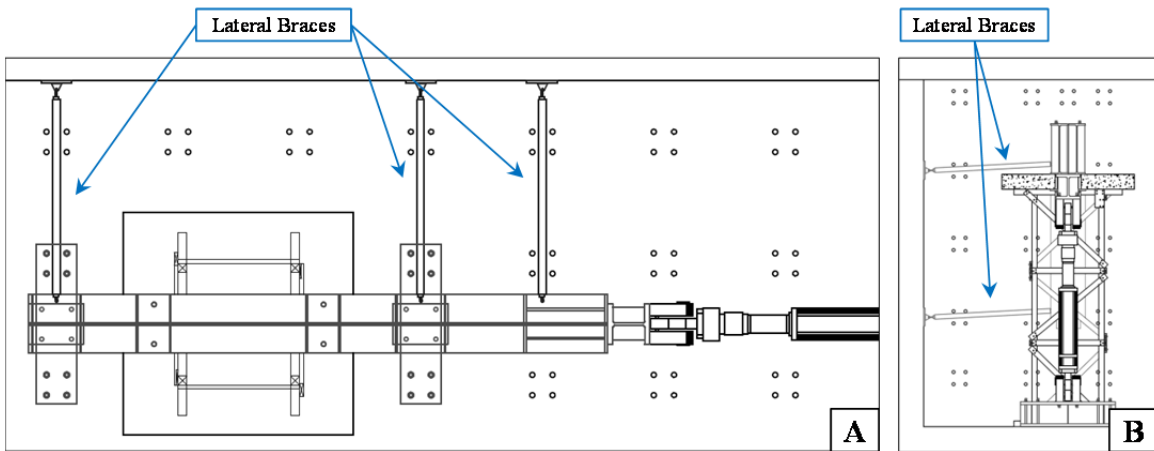
**Figure 3.3** Concrete Slab Detail A) Front View B) Side View

### 3.2.3 Safety Features

Safety was a priority while testing; therefore several safety features were installed to prevent the loading arm from falling. These components are discussed below.

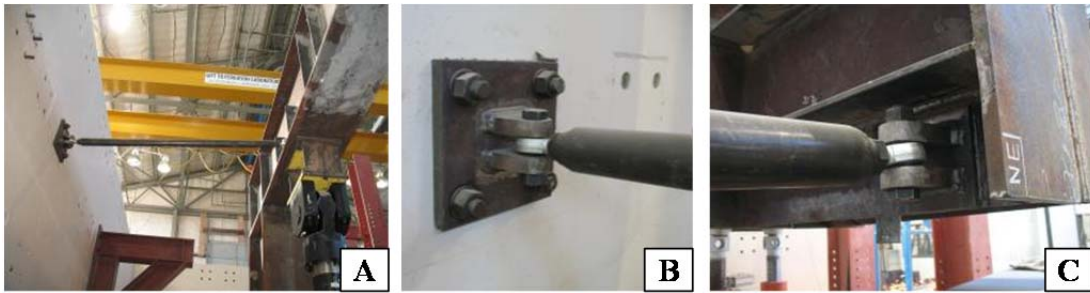
### 3.2.3.1 Lateral Braces

The L-frame was designed to move laterally in the plane of the page as seen in Figure 3.1-A. To prevent the frame from moving out of this plane and becoming unstable, three lateral braces were installed. These three braces were anchored to the strong wall behind the test setup. The locations of these lateral braces are presented in Figure 3.4.



**Figure 3.4** Locations of Lateral Braces A) Plan View B) Side View

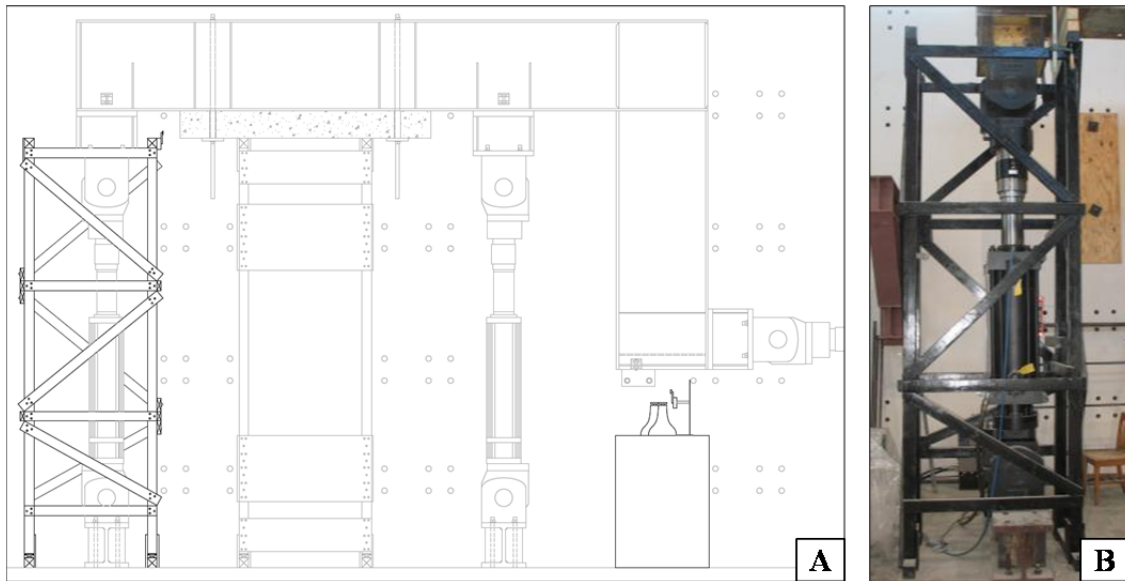
The lateral braces were comprised of a cylindrical steel tube with ball joints on each end. These ball joints were attached using threaded bolts which allowed the system to be loosened or tightened by turning of the cylindrical tube, much like a turn-buckle. The ball joints allowed for rotation of the brace in two axes, allowing the loading frame to move up and down or left and right while maintaining adequate stability. Photographs of the braces are displayed in Figure 3.5.



**Figure 3.5** Photographs of Lateral Bracing A) Side View B) Strong Wall Attachment C) L-frame Attachment

### 3.2.3.2 *Safety Shoring*

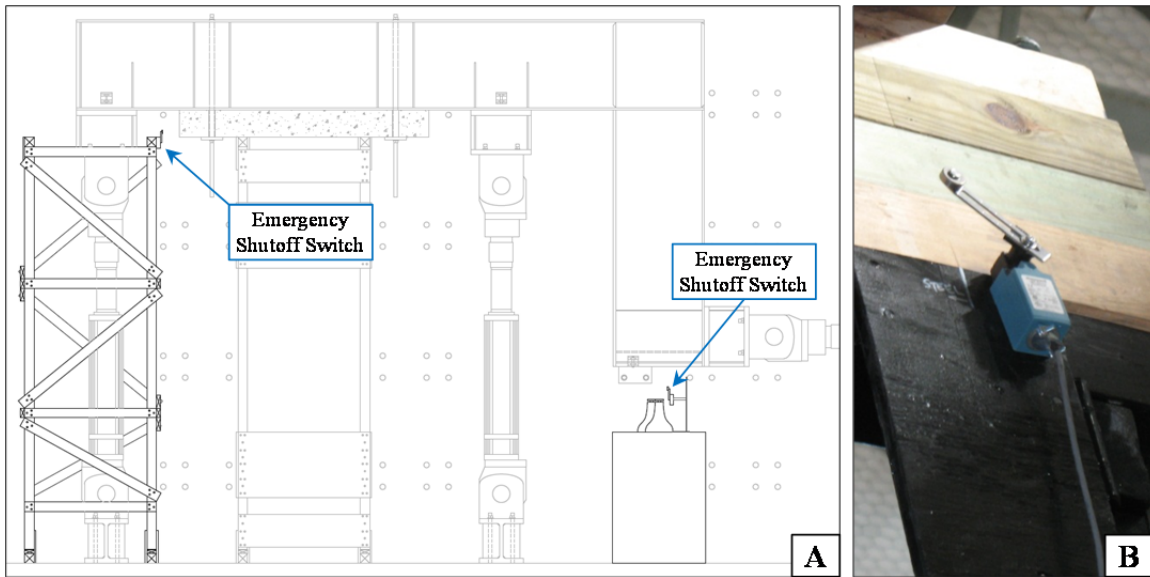
The total weight of the L-frame and loading slab was estimated at 26 kips. The vertical actuators at mid-stroke were the only supporting elements holding the loading frame when no shore was present. A concern was raised that if hydraulic pressure to the actuators was impeded, the weight of the frame would cause the pistons in the actuators to compress the remaining 15in of stroke. This large vertical displacement could fracture the lateral supports and the frame could fall. To prevent such a scenario, a safety shore was built around the left-most vertical actuator. This shore, along with two jacks placed under the short leg of the L-frame, would catch the test frame before the full stroke of the actuators was reached and before the displacement limits of the lateral braces was reached. The safety shore was built 10 inches shorter than the height of the L-frame at its pre-test equilibrium, allowing the safety shore to be in place during testing. Shown in Figure 3.6 are a schematic and a photograph of this safety shore. The safety shore and support jacks under the small leg of the L-frame are shown in bold.



**Figure 3.6** Safety Shore A) Design Drawing B) Photograph of Shore in Place

### **3.2.3.3 Emergency Shutoff Switches**

In addition to an emergency shutoff button to manually stop any action of the actuators, two shutoff switches were installed to stop testing should the frame exceeded the allowable vertical displacement. These two switches were located at the top of the emergency shoring tower, and above the jacks located below the short leg of the L-frame. Figure 3.7 shows the locations of these switches and a photograph of the switch at the top of the safety shore.



**Figure 3.7** Emergency Shutoff Switches A) Locations of Switches B) Photograph of Emergency Shutoff Switch

### 3.2.4 Limitations of the Test Setup

The design and components of the loading setup created a few limitations for testing. One major limitation was the speed at which the actuators could apply displacements for cyclic testing. As previously discussed, it was desired that the loading head remain level during lateral testing. However, the geometry of the test setup created uneven forces in the vertical actuators as the two resisted the moment created by the horizontal actuator. A program was created to adjust the loads in the two vertical actuators to maintain a level frame after each increment in horizontal displacement. This series of programmed loops limited the speed at which the system could provide lateral loading, thus one cycle took minutes rather than seconds.

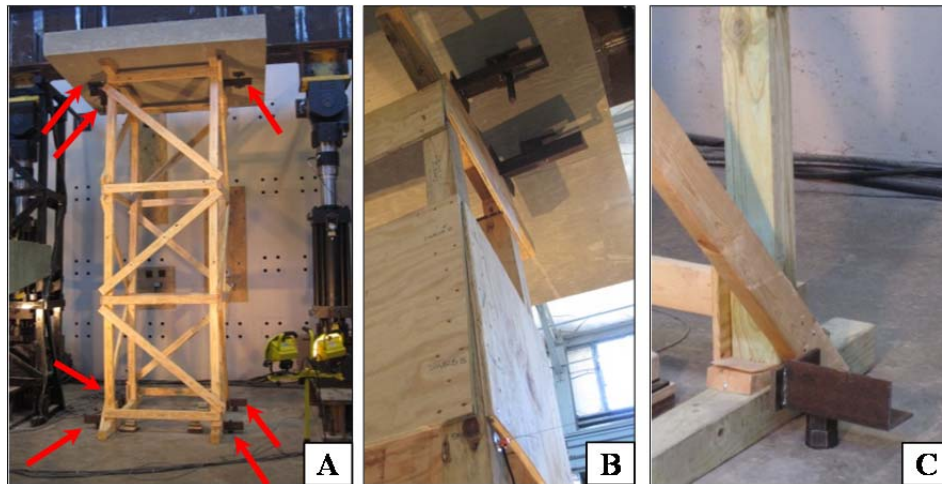
The geometry of the testing apparatus also limited dimensional changes in test specimens. Footprint (plan view) dimensional alterations were only limited by the locations of the concrete anchor rods, but the heights of the specimens were limited to a maximum height of 13 feet. Considerably shorter specimens could be tested with the

addition of blocking placed beneath the soles (footers), but taller towers required the entire frame to be altered. This was not feasible in the scope of the project, thus all towers were built to a height of 13 feet.

### 3.2.5 Specimen Slip Brackets

During the design phase of the test frame, it was unclear whether brackets should be used to prevent the slip of the shores during lateral and cyclic testing. While preventing slip provides more accurate test results, it does not always represent actual in-service conditions. After discussions with the representatives of US&R, it was decided that slip should be prevented during testing to facilitate accurate data collection.

Seven brackets were constructed to hold the headers and soles of the shore in place during lateral loading. These brackets were anchored to the strong floor for sole restraint, and to the concrete anchor rods for header restraint. Photographs of these slip brackets are provided in Figure 3.8.



**Figure 3.8** Slip Brackets A) Seven Locations B) Photograph of Header Brackets C) Photograph of Sole Bracket

Only one bracket was used to brace the right header due to the lack of extra thread available on the slab anchor rods. This brace was placed at the midpoint of the header and was anchored to the concrete slab using a concrete anchor bolt. All of the brackets were adjustable to allow a tight fit, and were anchored by snug tight nuts.

### **3.3 INSTRUMENTATION AND DOCUMENTATION**

To gather data regarding the load applied to the shores and displacement of the shores, two methods of data collection were used. Each method of data collection, and the means used to acquire the data is presented in this section.

#### **3.3.1 Actuator Data**

The primary means of data acquisition was through the instrumentation included in the MTS hydraulic actuators. Each actuator was equipped with a load cell and an LVDT displacement transducer which digitally reported data to the data acquisition program. Displacement, load and time measurements were recorded for the overall shore structure.

#### **3.3.2 Structural Response Data Collection**

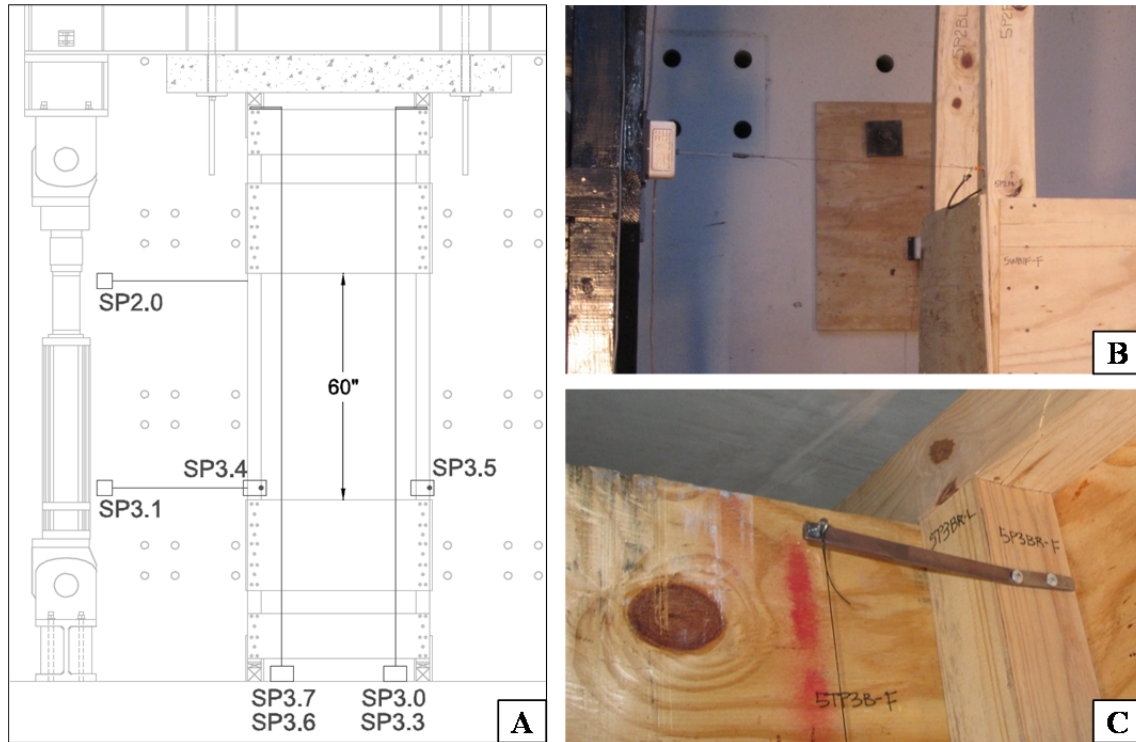
The specific axial and lateral structural response of the shore was obtained by means of data acquisition from displacement transducers in the form of string type linear potentiometers connected to the specimen in multiple locations (see Figure 3.9). Each potentiometer was attached to the specimen using poly-coated steel line and a steel screw eye with a magnetic release.

Four potentiometers were used to measure vertical displacement - one per post. To minimize steel line interference during testing, these potentiometers were offset from the posts using 12in. long steel bars cantilevered off the posts (see Figure 3.9). The potentiometer housing was held to the floor using steel blocks.

Lateral displacements were measured by four potentiometers anchored to either the strong wall or the safety shore. Connection of the steel line was made directly to the



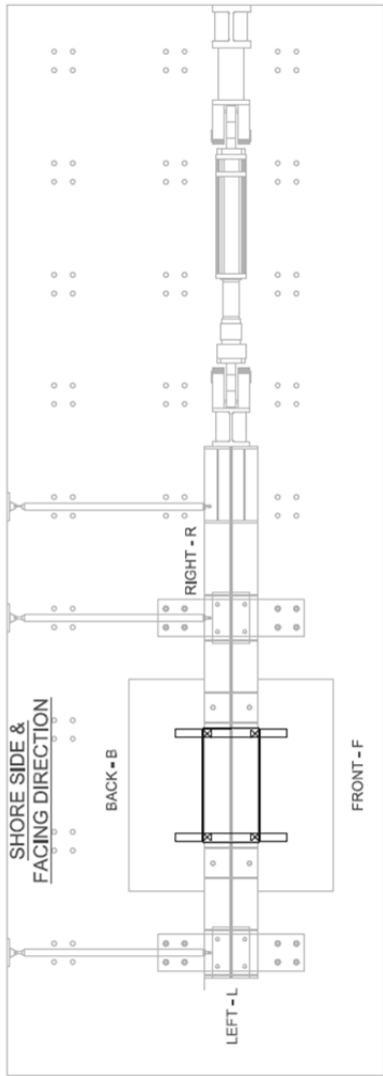
posts using screw eyes with a magnetic release, and was not offset. All string type linear potentiometers were calibrated prior to testing and data collection.



**Figure 3.9** Secondary Data Collection A) Example of String Potentiometer Locations  
B) Photograph of a Lateral Potentiometer C) Vertical Potentiometer Offset

### 3.3.3 Photographic and Video Documentation

A complete digital photographic record of each member of each shore prior to testing was compiled to compare pretest conditions to post-test failure photographs. To organize this database of close-up photographs, a member specific identification system was created. This five part identification number was written on each face of the individual members and post segments prior to photographing. Figure 3.10 presents the components of the identification code and the process of designating each member. An example of a member identification number is also depicted in Figure 3.11.

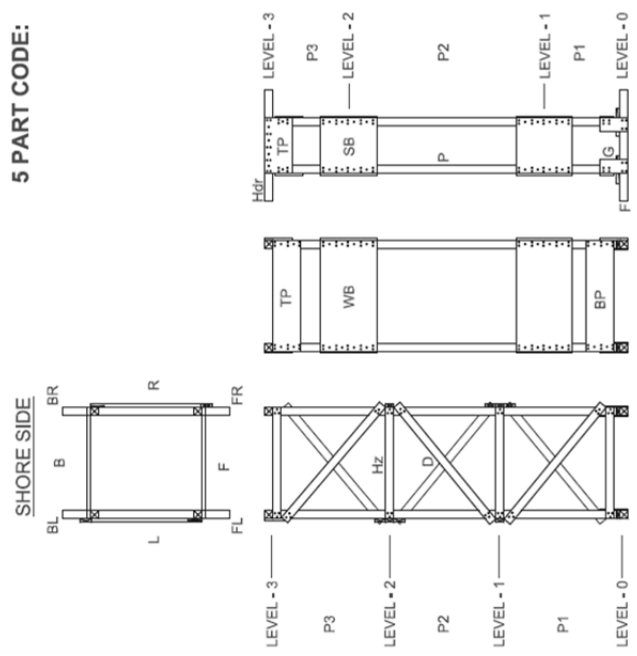


**5 PART CODE:** SPECIMEN # MEMBER TYPE LEVEL SHORE SIDE FACING DIRECTION

P	Hz	D	F	Hdr	WB	SB	TP	BP	G	J
-	-	-	-	-	-	-	-	-	-	-
POST	HORIZONTAL BRACE (2x4)	DIAGONAL BRACE (2x4)	FOOTER	HEADER	WIDE BRACE (Plywood)	SQUARE BRACE (Plywood)	TOP PLATE (Plywood)	BOTTOM PLATE (Plywood)	GUSSET (Half Gusset)	JOINT
F	B	L	R	FR	FL	BR	BL			
FRONT	BACK	LEFT	RIGHT	FRONT RIGHT	FRONT LEFT	BACK RIGHT	BACK LEFT			

**EXAMPLE IDENTIFICATION CALLOUTS**

- 1Hz3B-F > Shore #1 LP Horizontal Brace (2x4) at 3rd level on the back side facing the front (facing the inside of shore)
- 3P2FR-B > Shore #3, Post section between levels 1 and 2 on the front right corner facing the back



**Figure 3.10** Member Identification Code Designations



**Figure 3.11** Example of a Member ID Code: Shore #1, Base Plate, Ground Level, Back Side - Facing the Back

Digital photographs were taken during testing to document the performance of wedges, areas of distress, and the individual failures of each post. After complete shore failure, all areas of failure or distress were photographed and compiled in a post-failure database. These photographs were then compared to the pretest database using the respective member identification code.

Two video cameras were used during testing to document the behavior of each shore from two separate angles. Videos include narration of the different stages of testing, load values and horizontal displacement. Audible responses (cracking) of the shores were also documented on the videos.

### **3.4 TEST MATRIX AND LOADING SCENARIOS**

A total of 13 specimens were tested to failure, six LP shores and seven PLP shores. All shores were consistent with the design specifications later outlined in *Section 4.5* with the exception of shore 10. Shore 10 was constructed using No.2 grade southern yellow pine; all other USACE FOG design requirements were upheld. Table 3-1 outlines the types of shores and loading sequences used for each of the 13 specimens.

**Table 3-1** Test Matrix

Shore No.	Shore Type	Loading Scenario
1	PLP*	[A] Vertical Load Only
2	PLP	[A] Vertical Load Only
3	LP	[A] Vertical Load Only
4	LP	[A*] Vertical Load Only (load-controlled)
5	PLP*	[B] Cyclic Loading Under Two Levels of Vertical Load
6	LP	[C] Constant Lateral Displacement (6in) Increasing Vertical Load
7	PLP	[C] Constant Lateral Displacement (6in) Increasing Vertical Load
8	LP	[D] Constant Vertical Load (32kips), Increasing Lateral Displacement
9	PLP	[D] Constant Vertical Load (32kips), Increasing Lateral Displacement
10	LP*	[B] Cyclic Loading Under Two Levels of Vertical Load
11	LP	[B] Cyclic Loading Under Two Levels of Vertical Load
12	PLP	[E] Rapid Vertical Loading Only
13	PLP	[F] Sustained Vertical Load Only (72kips for 8hrs)

LP: Standard Laced Post Shore

LP\*: Laced Post Shore No.2 SYP

PLP: 5ft Clear Space Plywood Laced Post Shore

PLP\*: 4ft Clear Space Plywood Laced Post Shore

Shores 1-4 were tested under vertical loading only and acted as both a baseline test for the investigation, and a baseline comparison to previous tests conducted by US&R. Tests 1 and 2 were conducted to investigate the difference in capacity of a PLP shore based on the spacing of the intermediate braces. Tests 3 and 4 were conducted to investigate the effects of displacement-controlled loading versus load-controlled loading. After the comparison of the results, it was determined that no significant difference in capacity was achieved when using either loading method. The notable difference in the two loading methods was the observed failure rate of the shore after the peak load was achieved. Load-controlled loading caused a rapid failure after the peak load because the loading head descended rapidly to maintain loading. Displacement-controlled loading maintained a constant rate of descent after the peak load was reached, regardless of the applied load variation. This allowed the observation of each individual post failure in

succession. Therefore all remaining tests were conducted using displacement-controlled loading.

Tests 5-11 involved the combined effects of vertical loading and lateral displacements on both LP and PLP shores. Each specific scenario was conducted on one LP and one PLP shore for comparison.

Tests 12 and 13 were conducted on PLP shores to investigate load rate effects on capacity. All loading scenarios are discussed in further detail below.

### **3.4.1 Loading Scenario A**

Shores 1, 2, and 3 were vertically loaded by moving the load frame downward using the two vertical MTS actuators while maintaining a horizontally level loading head. No lateral movement of the loading frame was permitted. Loading was administered using displacement-control by increasing the amount of vertical movement at a constant rate of 0.2 in/min.

Shore 4 was vertically loaded in a load-controlled method by incrementing the amount of load applied to the shore at a constant rate of 10kips/min. Both vertical actuators applied one-half of the load, and maintained a level loading head during testing. No lateral movement of the loading frame was permitted. After first failure, the rate of loading was maintained until complete failure of the shore was reached or the test was terminated due to safety concerns.

### **3.4.2 Loading Scenario B**

Shores 5, 10, and 11 were subjected to cyclic lateral loading while a constant vertical load of 32kips was applied. After initial vertical loading, the top of the shore was laterally displaced to an amplitude of 2in. to the left and then 2in. to the right for a total of three cycles at a rate of approximately 3.5in/min. A level loading head was maintained during all cycles, and slip of the headers or soles was prevented using the slip brackets discussed in *Section 3.2.5*. Upon completion of three cycles at  $\pm 2$ in. amplitudes, the shore was laterally displaced  $\pm 4$ in. for an additional 3 cycles. The shore was then

brought to the initial pretest position and the vertical load increased to 48kips before repeating the cyclic loading process starting with  $\pm 2$ in. amplitudes and increasing to  $\pm 4$ in. amplitudes. After the completion of this secondary round of cyclic lateral loading, the shore was returned to the initial pretest position and the vertical load was increased to failure using displacement-control.

### **3.4.3 Loading Scenario C**

Shores 6 and 7 were tested with a combination of vertical load and initial constant lateral displacement. The total out-of-plumb of the top of each shore was measured prior to loading. The top of the shore was then displaced laterally in the same direction as the initial misalignment to a total out-of-plumb of 6in. For example, if the shore was initially out-of-plumb 1in., the shore was displaced an additional 5in in the same direction to achieve a total lateral displacement of 6in. The shore was then vertically loaded to failure using a displacement-controlled loading rate of 0.2in/min. No additional lateral movement of the loading frame was permitted.

### **3.4.4 Loading Scenario D**

Shores 8 and 9 were tested by increasing lateral displacement of the top at a rate of approximately 0.6in/min while maintaining a constant vertical applied load of 32kips. The maximum possible lateral displacement was 15in. due to the available stroke length of the horizontal MTS actuator. If the shore had not failed prior to reaching the 15in. threshold, vertical load was increased to failure while maintaining the 15in. lateral displacement.

### **3.4.5 Loading Scenario E**

The strength properties of wood are sensitive to the rate at which the load is applied. When loaded rapidly, wood often exhibits higher capacities. To investigate this material characteristic, shore 12 was loaded at twice the rate of the comparable baseline test (shore 2). Shore 12 was loaded vertically at a rate of 0.4in/min with no lateral

movement of the loading frame permitted.

#### **3.4.6 Loading Scenario F**

In contrast to the higher capacities under rapid loading, wood experiences sustained loading effects such as creep, which can produce lower capacities over time. To investigate sustain loading effects, shore 13 was loaded to 72kips (85 percent of the capacity of shore 12) and the load was held constant for eight hours. No lateral displacement of the loading frame was permitted. After eight hours, the shore was tested to failure using displacement-controlled vertical loading.

## CHAPTER 4

### Specimen Design and Construction

Design and construction of the test specimens involved the use of two types of shores: Laced Post (LP) and Plywood Laced Post (PLP) which were described in *Chapter 2: Background*. This chapter discusses the details and processes used to build the 13 test specimens. In particular, discussion of materials, design requirements, design details and the construction process are presented.

#### 4.1 KEY TEST SPECIMEN FEATURES

A primary objective of this research was to compare the performance of LP and PLP shores. This objective was an important factor in developing the test matrix (Table 3-1) which involved the testing of at least one LP and one PLP per load scenario. As discussed in *Chapter 2*, US&R has recently added the PLP tower to the USACE FOG, thus additional tests were focused on the PLP style. In total, six LP shores and seven PLP shores were constructed and tested.

##### 4.1.1 Dimensional Restrictions

As was discussed in *Section 3.2.4 Limitations of the Test Setup*, load frame geometry restricted the height of the shores to a maximum of 13ft. The testing of shorter specimens was possible, but taller shores were expected to provide lower critical values due to longer unbraced lengths. In addition to test frame constraints, previous testing by US&R was conducted on 12.5ft shores. The similar heights allowed a comparison of previous test data to this investigation.

##### 4.1.2 Lumber Species

During an emergency situation, US&R teams utilize the most readily available species of wood in the disaster region. Typically, a dense species such as Douglas fir-larch in the number 1 grade of lumber is preferred, but not always accessible.



In southern states such as Texas, a common type of lumber is southern yellow pine (SYP). The term southern yellow pine can refer to any one of four species of trees: longleaf pine, shortleaf pine, loblolly pine and slash pine (Forest Products Laboratory, USDA Forest Service, 2010). The material properties of southern yellow pine as listed in the *National Design Specification for Wood Construction 2005 (NDS)* are slightly lower than that of Douglas fir-larch. Using the appropriate size factor values ( $C_F$ ) for 2x4 and 4x4 dimensional lumber, the material properties of Douglas fir-larch are compared to those of southern yellow pine in Table 4-1. Also included is the short-term loading rate adjustment value. The short-term ultimate design values are 2.1 times larger than the published values for members loaded to failure within a 5-10 minute testing period.

**Table 4-1:** Comparison of the Material Properties of Douglas Fir-Larch and Southern Yellow Pine

		Douglas Fir-Larch			Southern Yellow Pine
		Size Factor $C_F$	Tabulated Value (psi)	Adjusted Value (x $C_F$ x 2.1), psi	Preadjusted, Tabulated Value ( x 2.1) (psi)
<b>Design Value</b>	Bending ( $F_b$ )	1.5	1000	<b>3150</b>	<b>3885</b>
	Compression ( $F_C$ )	1.15	1500	<b>3622.5</b>	<b>3885</b>
	Compression Perpendicular to Grain ( $F_{C\perp}$ )	-	625	<b>1312.5</b>	<b>1186.5</b>
	Average Modulus of Elasticity (E)	-	1700000	<b>1700000</b>	<b>1700000</b>

It can be seen in Table 4-1 that the design values for bending and compression parallel to grain are lower for Douglas fir-larch. However, the compression perpendicular to grain, the strength property used to predict the capacity of the shores, is larger for Douglas fir-larch. All published values are average values, and the standard deviation of the actual strengths of the members in a shore can vary, providing an array of strength results.

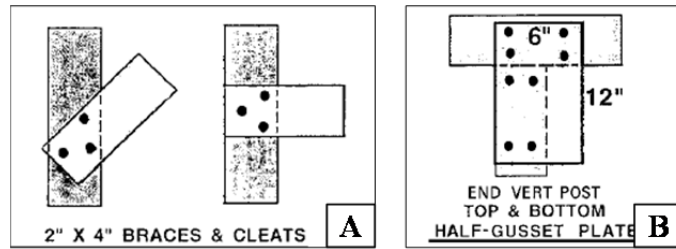
Since it is likely that southern yellow pine No. 1 would be the most readily available lumber in Texas, it was selected as the material used to construct the specimens. This also allows for a comparison of lumber species since all previously tested FEMA shores were fabricated with Douglas fir-larch.

#### **4.2 NAIL REQUIREMENTS**

Nails are the commonly specified type of fasteners used to assemble US&R emergency shoring primarily for the speed at which they can be driven. Shoring towers can be erected quickly since the gun-driven nails are quickly installed and provide adequate strength for the connections. Secondly, nails are readily available in most areas of the country allowing easy acquisition during a crisis situation. US&R regulates the type, size and patterns of nails used in constructing shoring towers.

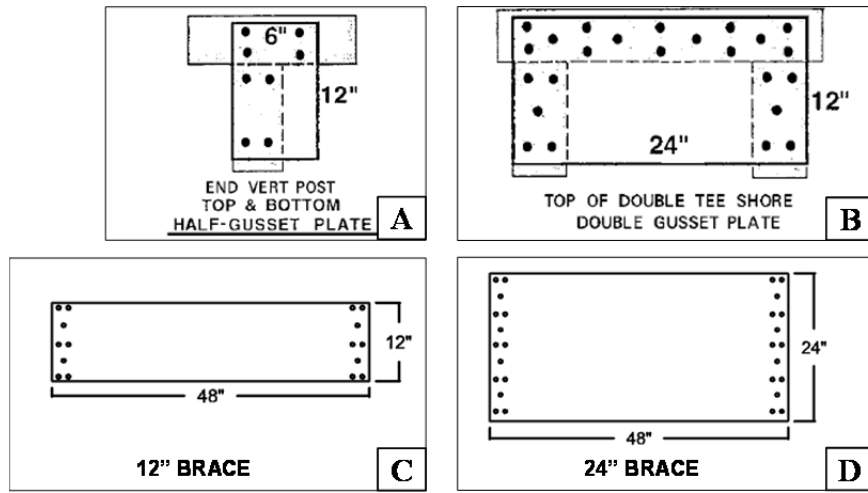
The US&R FOG specifies that all nails used to fasten plywood to dimensional lumber must be 8d nails (0.131in. x 2.5in.) with a vinyl coating to facilitate a smooth entry of the nail, reducing the risk of splitting the wood. In order to fasten dimension lumber members, 16d vinyl coated sinker nails (0.148in. x 3.25in.) must be used. As a supplement to the 16d sinker nails, 12d common nails (0.148in. x 3.25in.) with a vinyl coating are permitted, as their dimensions are the same. All nails must be full headed nails driven by a nail gun, typically a pneumatic nail gun.

Each connection of the wood shoring tower has a specified nailing pattern that is presented in the US&R FOG. As stated above, the size of the nails used depends on the sizes of the two wood members being joined. Figure 4.1 below shows the different types of nail patterns used in constructing a laced post tower as shown on page 3-20 in the US&R FOG.



**Figure 4.1** Nailing Patterns used for Laced Post Shores

The plywood laced post shores require a different set of nail patterns for the plywood braces rather than the 2x4 brace pattern shown in Figure 4.1-A. The nail configurations used to attach plywood braces for a PLP are shown in Figure 4.2 below.



**Figure 4.2** Nailing Patterns used for a Plywood Laced Post Shores

Each nail pattern was used in the construction of its respective type of shore (LP or PLP), and can be seen in the global design of a shore as presented in *Section 4.3*.

### 4.3 SPECIMEN DESIGN

This section describes the overall design of both the laced post shore (LP) and the plywood laced post shore (PLP) as constructed. In particular, design details, design drawings and photographs are presented.

### **4.3.1 Laced Post Shore Design**

The laced post design utilizes a K system of bracing comprised of dimension lumber, either 2x4 or 2x6, depending on the size of the posts. The height of the shore determines the number of intermediate braces required to provide adequate stiffness and stability. Figure 4.3 shows the US&R FOG blueprint for the design and construction of laced post shores. All LP shores were designed in accordance with these specifications.

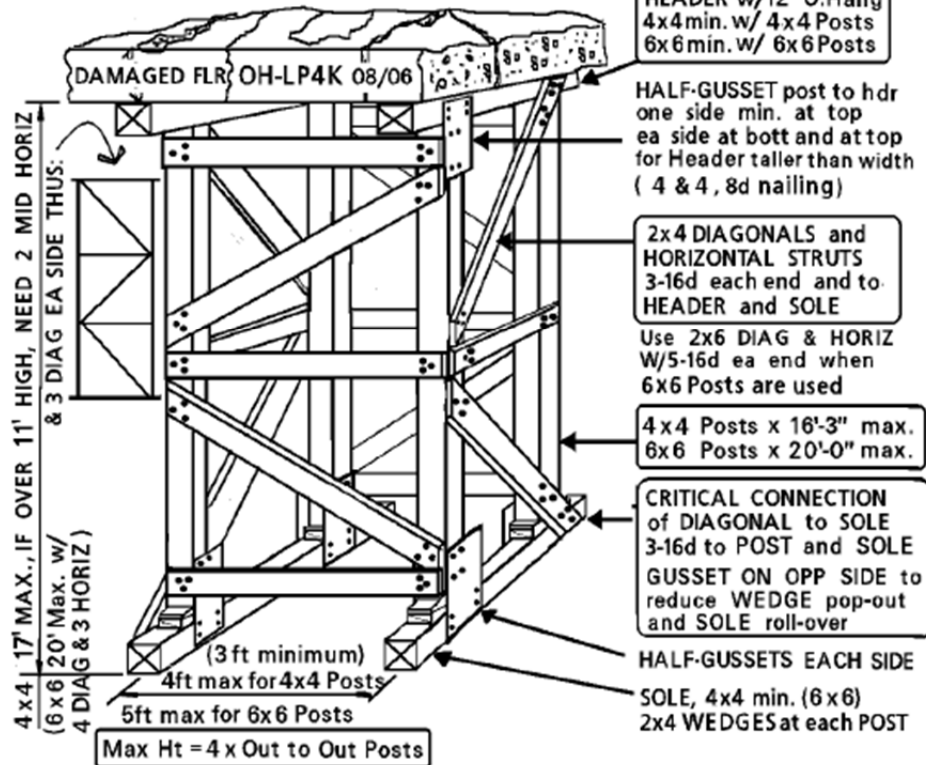
**US&R STRUCTURES SPECIALIST FOG  
CONSTRUCTING VERTICAL SHORING SYSTEMS**

**LACED POST SHORE**

CLASS 3 SHORE • POSTS SAME SPACING EA.WAY

High capacity four post system that can be used to shore a damaged Concrete Floor or Heavily Loaded Wood Floor It is constructed similar to a pair of 2-Post Vertical Shores but laced together

LACED POST MAY BE USED AS SAFE HAVEN



**Figure 4.3 US&R FOG Laced Post Shore Design Details**

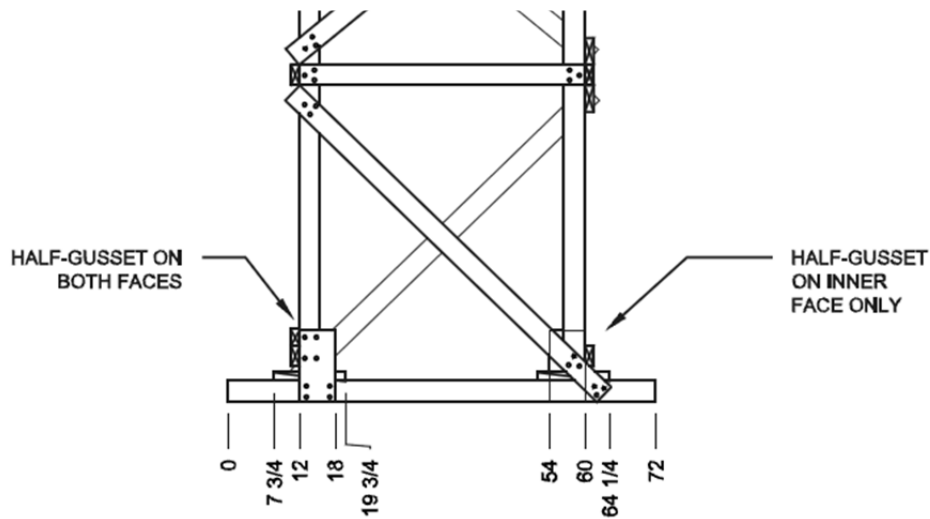
#### ***4.3.1.1 Global Dimensions***

As previously discussed, the test setup restricted the height of all specimens to 13ft. According to Figure 4.3, any shore over 11ft must have two interior horizontal braces and three diagonal braces. Therefore all LP specimens were designed with three equal vertical bays.

Dimensional lumber was restricted to 2x4 lumber for the braces, and 4x4 lumber for the posts, headers, and sole (footer). A 4ft x 4ft footprint was used in accordance with the specifications shown in Figure 4.3 for a 4x4 post shore.

#### ***4.3.1.2 Headers and Soles***

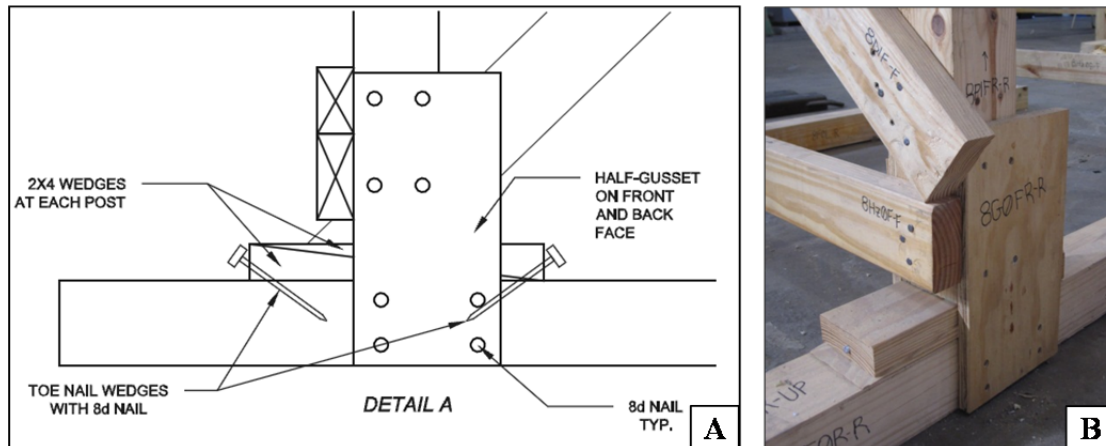
Headers and soles were designed to be 6ft long in accordance with the 12in overhang requirement on each side of the posts. The headers and soles were fastened to the posts using half-gussets and 2x4 diagonal braces (see Figure 4.4). A half-gusset consists of a 12 in. x 6 in. plywood panel nailed to the two adjoining members using the double 4 nail pattern shown in Figure 4.1-B. The plywood used for the half-gusset plates was 5/8-in CDX plywood. This was not specified in the FOG, but was determined by the US&R shoring advisors, John O'Connell and David Hammond for this project as consistent with typical practices.



**Figure 4.4** Design Drawing of the Base of a LP Shore

#### 4.3.1.3 Wedges

In practice, wedges made out of 2x4 lumber are used to create a tight fit between the shore's mainframe and the floors of a damaged structure. These wedges were included in the test specimens, though they were not specifically used to snug the test specimen in the loading frame. Figure 4.5 shows the design of these wedges. The wedges also act as a warning device for shore overload, which is discussed in further detail in *Section 4.4*.

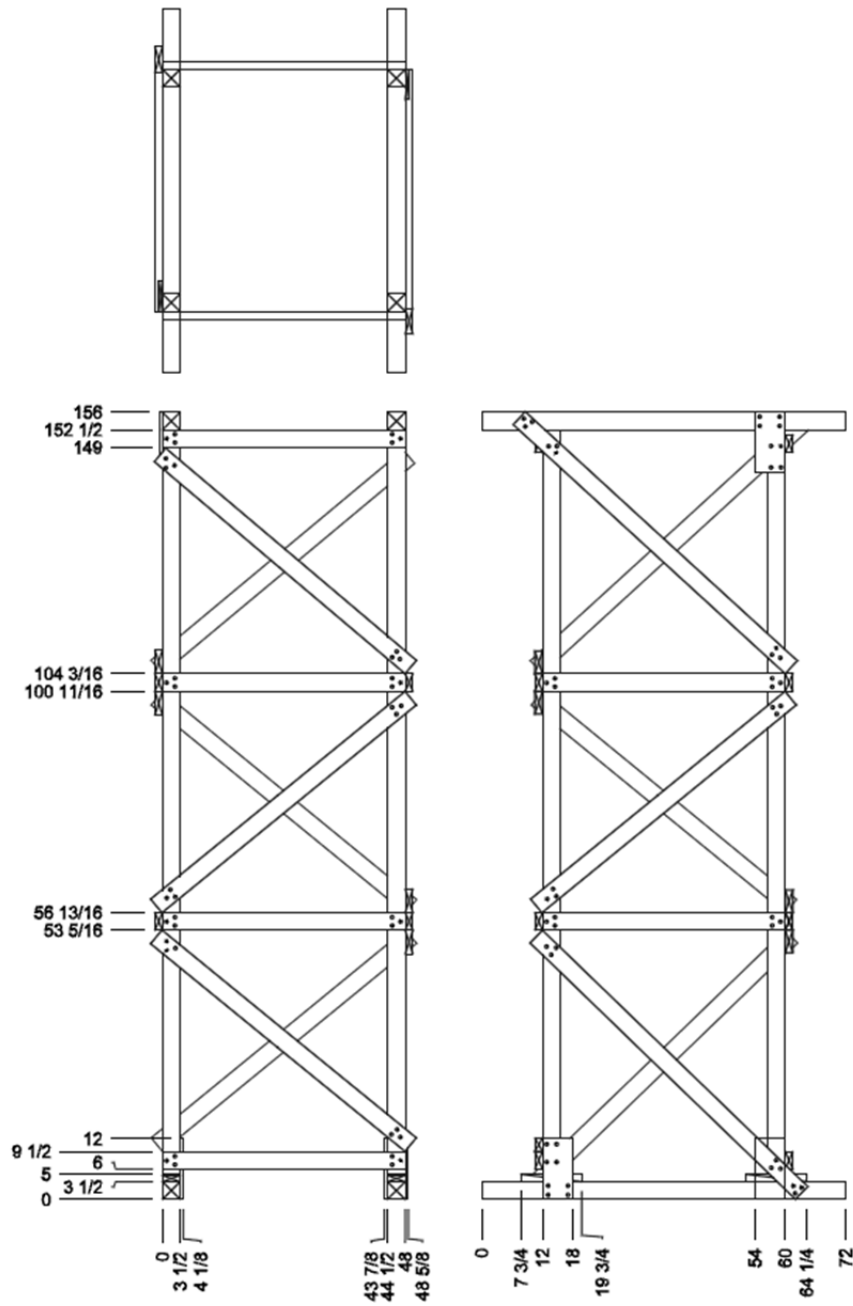


**Figure 4.5** Wedge Design A) Drawing Detail B) Photograph of Wedge

#### ***4.3.1.4 Horizontal and Diagonal Bracing***

Horizontal and diagonal braces were constructed using 2x4 lumber per the specifications in Figure 4.3. All horizontal members were 4ft in length and were used to maintain even spacing of the posts during construction. The first and third bay diagonals extended past the posts to the header and sole respectively. These diagonals were not only fastened to the posts but also the header or sole (see Figure 4.4). Though the US&R FOG shows all ends of these diagonals cut flush with the edge of the post, this was not done for the test specimens. The US&R shoring advisors for the project indicated that cutting the diagonals flush with the edge of the post was not common practice for two reasons. First, cutting the ends to be flush takes a considerable amount of time and has no practical impact. Second, the likelihood of splitting the 2x4 while driving the nails is reduced due to the increased length from the nail to the board end. A complete diagram of an assembled LP shore is shown below in Figure 4.6, and photographs of completed shores in Figure 4.7.





**Figure 4.6** Laced Post As-Built Drawing



**Figure 4.7** Photographs of Constructed LP Shores

### **4.3.2 Plywood Laced Post Shore Design**

Plywood laced post (PLP) shores utilize plywood panels to provide stiffness and stability. The 6<sup>th</sup> edition (Feb 2009) US&R Field Operations Guide (FOG) does not include specific design specifications for the PLP as it does for the LP. However, specific design instructions were provided by the US&R shoring advisors, John O’Connell and David Hammond. These instructions were used to design and build all PLP shores in this investigation. The design details are discussed herein. After the fabrication of all PLP shores had been completed, the July 2011 FOG was published which included the same PLP specifications provided by John O’Connell and David Hammond (see *Chapter 2*).

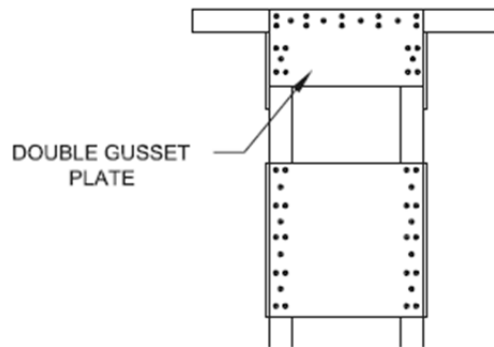
#### 4.3.2.1 Global Dimensions

Similar to the LP design, the test setup restricted the height of all specimens to 13ft. For a PLP shore of this height, two intermediate plywood braces were required for stability in addition to bracing at the header and sole. All bracing consisted of 5/8-in. CDX plywood, and all posts, headers, and soles were 4x4 dimensional lumber.

Plywood laced post shores are permitted to be designed with either a 2ft x 4ft footprint, or the standard 4ft x 4ft footprint. All PLP towers built and tested in this investigation had a 2ft x 4ft footprint.

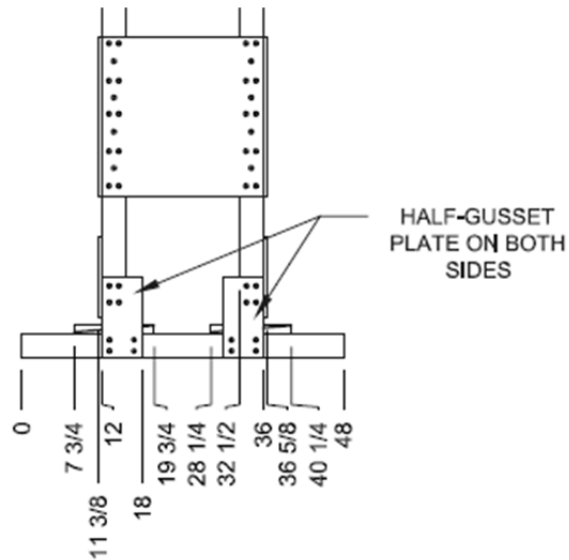
#### 4.3.2.2 Headers and Soles

Headers and soles were designed to be 4ft long in accordance with the 12in overhang requirement on each side of the posts in the 2ft dimension. Each header was fastened to the posts using a double gusset plate (12in x 24in plywood brace) as shown in Figure 4.8.



**Figure 4.8** Design Drawing of the Header of a PLP Shore

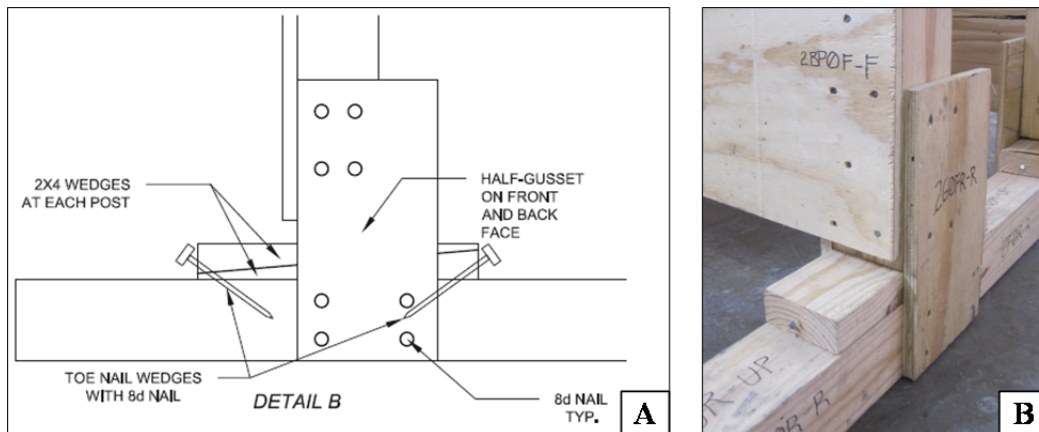
Each sole was fastened to the posts using two half-gusset plates, one on each face. A half-gusset consists of a 12in x 6in plywood board nailed to the two adjoining members using the double 4 nail pattern shown in Figure 4.1-B. Figure 4.9 shows the design for this connection.



**Figure 4.9** Design Drawing for the Base of a PLP Shore

#### 4.3.2.3 Wedges

All PLP towers were built with the same style of wedges found on the LP towers. A design detail and photograph of these wedges is provided below.



**Figure 4.10** Wedge Design A) Drawing Detail B) Photograph of Wedge

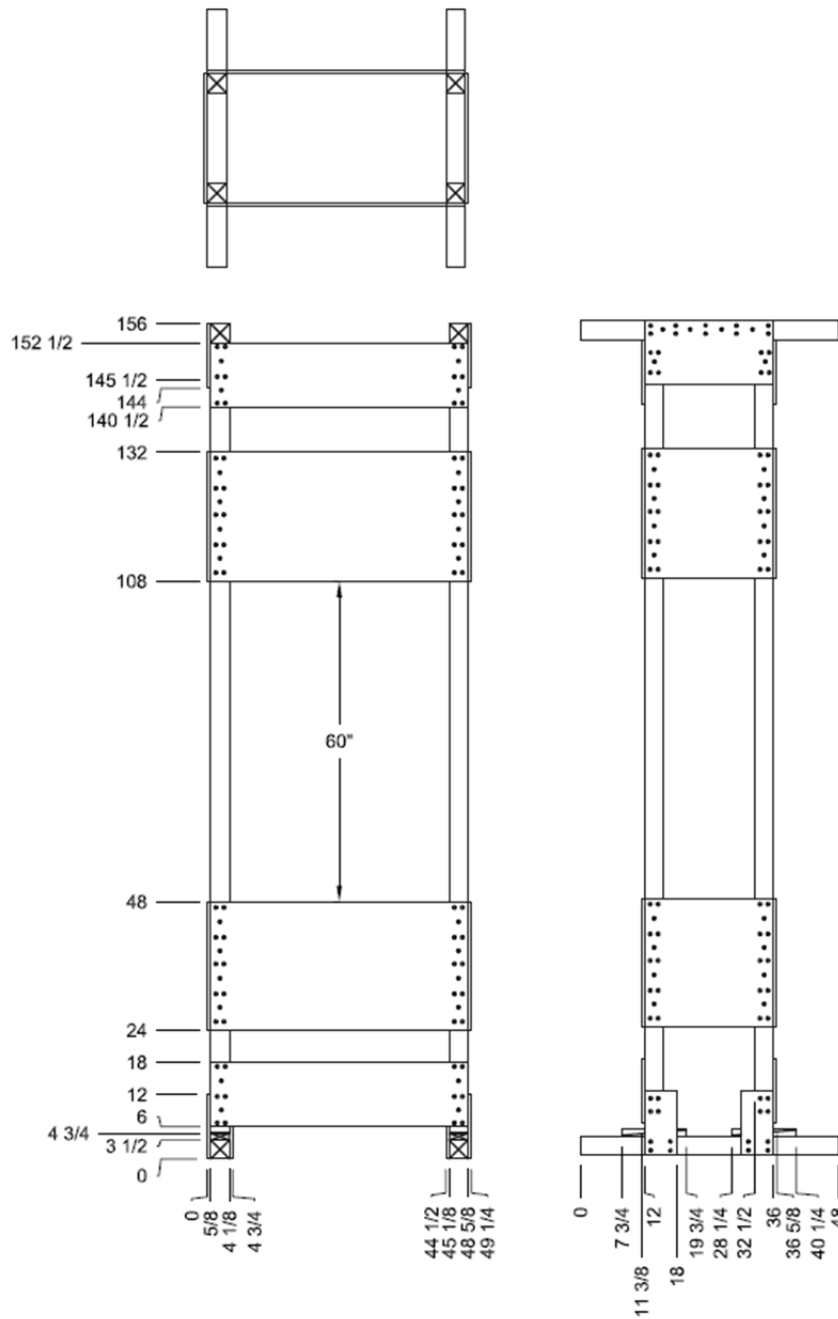
#### **4.3.2.4 Panel Bracing**

All panel braces were 5/8-in. CDX plywood connected to the 4x4 members using 8d common nails. Spacing of these braces was specifically designated by John O'Connell and David Hammond.

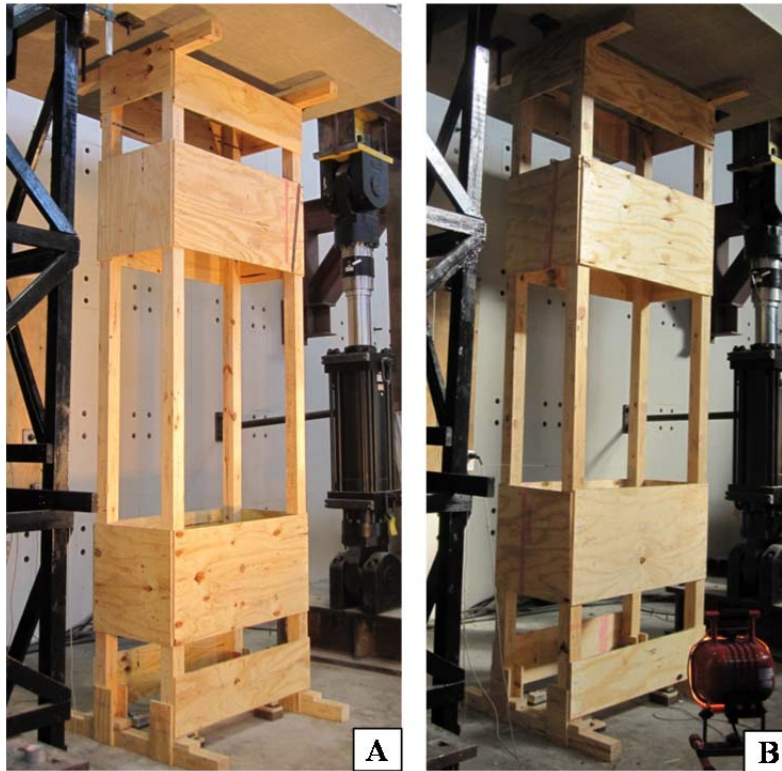
The top plate consisted of a 12in. x 48in. panel attached to the post directly under the header using an 8-8d nail pattern. The base plate consisted of a 12in. x 48in. panel attached to the post approximately 1in above the sole also using an 8-8d nail pattern.

The two intermediate braces on each side of the shore were 24in. tall and spanned the full width of either the 48in. or 24in. dimension of the shore. These braces were specifically spaced 24in. from either the top or bottom of the shore respectively. For a 13ft specimen, this created a 60in. clear space between intermediate braces. However, two PLP towers were built with an intermediate brace spacing of 30in. from the top/bottom leaving a 48in. intermediate clear spacing between braces. These towers were built to investigate the behavior of a tower with a shorter clear spacing.

All intermediate braces were fastened to the posts using a 14-8d nail pattern. A complete diagram of an assembled PLP shore is shown in Figure 4.11, and photographs of completed shores in Figure 4.12.



**Figure 4.11** Plywood Laced Post As-Built Drawing



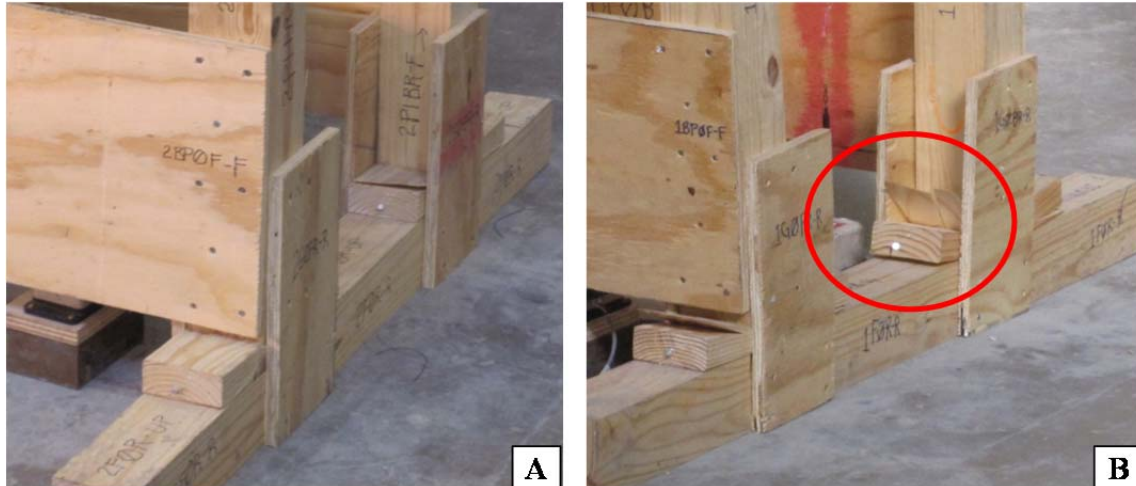
**Figure 4.12** Photographs of Constructed PLP Shores in Test Frame A) 5ft Clear Span PLP B) 4ft Clear Span PLP

#### **4.4 REVIEW OF FUSES**

A full discussion of fuses can be found in *Chapter 2*, but will be briefly reviewed. Fuses are any type of early warning device or characteristic observation that can alert trained US&R personnel that a shoring system is overloaded. For both LP and PLP towers, there are a few fuses that can be used to detect an overload. The performance of these fuses was an area of interest during testing. Observations are included in *Chapter 5: Test Results*.

The wedges, located at the base of each of the four posts can be used as an emergency fuse. These wedges will often “cup” or bow upwards as the load in the post increases. The presence of and amount of cupping can alert US&R individuals that the shore is experiencing loading that may be approaching the capacity of the shore. Figure

4.13 shows an example of a cupped wedge, and also shows the inconsistency in the magnitude of wedge cupping.



**Figure 4.13** Photographs of Cupping Wedges A) Initial Cupping Under Smaller Loads  
B) Extreme Cupping Under High Loads

It can be seen in Figure 4.13-B that a set of wedges under one post can cup significantly more than under another post in the same shore. In some cases, cupping may not be significant in any set of wedges under extreme loading. These observations will be discussed in greater detail in Chapters 5 and 6.

Cupping of wedges is a visual fuse, but the sound of wood creaking, cracking, and breaking can be used as a type of audible fuse. As loads increase, the wood will make audible sounds as loads are redistributed or when fibers become more inelastic. These sounds are often loud and can warn US&R personnel in the vicinity of shore overload.

Splitting of headers or footers can also be observed if a shore experiences high loads. This splitting not only creates an audible fuse, but provides a specific region on the shore for trained personal to look for splitting.

It was observed in previous tests conducted by US&R teams, that water held in the fibers of moist headers and soles was expelled as the load increased. This was not



observed during the tests conducted for this investigation.

#### 4.5 SHORE CONSTRUCTION PROCESS

The construction process for both the LP and PLP shores is very similar. The process described in this section was outlined with the help of US&R shoring advisor John O’Connell. These processes were used to build all 13 shores. Some suggestions for ease of construction in a controlled environment are also provided, but do not necessarily represent the process used in the field.

##### 4.5.1 Laced Post Fabrication Process

The process used by John O’Connell and the researchers at FSEL to construct a 13ft tall laced post shore with a footprint of 4ft x 4ft is outlined below:

**Table 4-2** Procedure Used to Construct a Laced Post Shore

Step No.	Description
1	All 4-4x4 posts were cut to size ( 12'-3.5" ) at the same time. The length of the post was the total height of shore (13ft) minus 8.5in (header + sole + wedge thicknesses).
2	Headers and soles (4x4) were cut to length (6ft) such that there was 12in of overhang. A line was made at 12in from each end to designate the location of the edge of the posts.
3	The first two posts, header, and sole were laid on the floor. The posts were aligned with the header at the 12in marks from the end. One nail for each post was used to toe-nail the post to the header to temporarily secure the alignment of the post.
4	A carpenter's square was used to square up each post to the header.
5	Eight half-gusset plates (12in x 6in) were cut using 5/8in CDX plywood. One half-gusset plate was attached to the right post and header using the 4 and 4, 8d nailing pattern.
6	All 12-48in horizontal braces were cut using 2x4 lumber. The first 48in horizontal cross brace was attached at 51-13/16in from the top of the header with 3-12d nails at each end. The posts should measure 4ft (48in) out-to-out, such that the brace ends are flush with the edges of the posts.

**Table 4-2** Procedure Used to Construct a Laced Post Shore (continued)

Step No.	Description
7	The second 4ft horizontal cross brace was attached at 99-3/16in from the top of the header with 3-12d nails at each end. The posts should measure 4ft out-to-out, such that the brace ends are flush with the edges of the post.
8	The sole is aligned with the outer edges of the posts at the 12in marks from the ends. Four pairs of wedges were created by cutting 4-12in long 2x4s in a diagonal fashion through the 3.5in (4in nominal) dimension. One pair of wedges was then centered between each post end and the sole.
9	Each end of each wedge pair was toe-nailed into the sole to hold it in place using 1-8d nail.
10	A half-gusset plate was fastened to the bottom left intersection of the post and sole which created a tight fit between the post, wedges and sole. Care was taken not to fire any of the nails of the 4 and 4 - 8d pattern into the wedges.
11	Each 2x4 diagonal brace was then cut to length: 4-73in long and 8-65in long. The diagonal braces were aligned such that the corners align with the corner of the horizontal braces. This leaves the opposite corner to overhang from the edge of the post.
12	Each diagonal brace was attached with 3-12d nails at each end. The diagonal braces that connected to the header/sole were placed such that the edge of the 2x4 aligned with the inner corner of the post where it met the wedges. The 2x4 should not extend past the top edge of the header or below the bottom edge of the sole.
13	The completed side of the shore was left on the floor and construction of an identical side was conducted on top of the first. In essence, the first completed side acted as a guide for the second side. All half-gussets and diagonals were constructed in the same locations as the first.
14	Steps 1-12 were repeated for the second shore side.
15	The two shore sides were then stood up on the ends of their headers and soles. This was conducted such that one side was stood up clockwise and the other counter-clockwise so the braces were on the exterior. Thus, looking through the sides of the shores created an 'X' out of the diagonal braces in each bay.
16	Each side was separated from one another by 4ft out-to-out.
17	The 4ft horizontal cross brace was placed at the top, flush under the headers. To allow for adjustment, 1-12d nail was driven into the brace on each side.

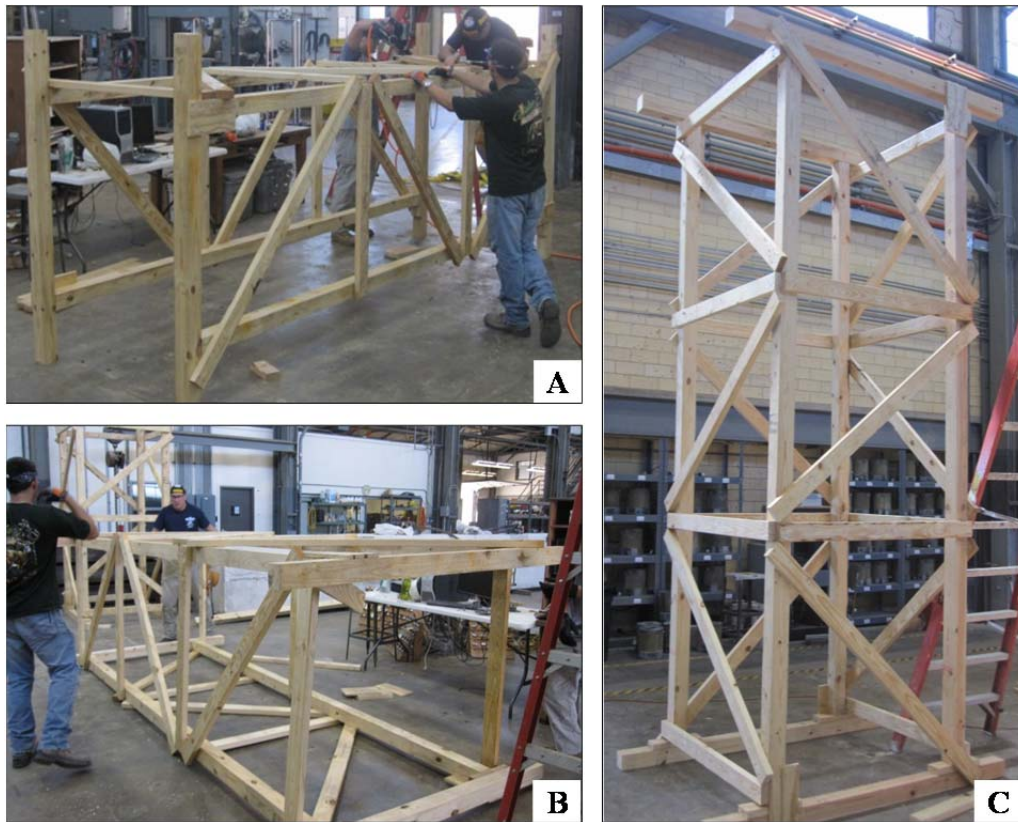
**Table 4-2** Procedure Used to Construct a Laced Post Shore (continued)

<b>Step No.</b>	<b>Description</b>
18	The 4ft horizontal cross brace was placed at the bottom with approximately 1 in of separation from the wedges. Again, 1-12d nail was driven in the brace on each side
19	A tape measure was used to measure the distance from the outside corner of each post across the shore in an 'X' to square the entire shore. Once these two distances were equal, the remaining 12d nails were driven into the top and bottom horizontal cross braces.
20	The two remaining intermediate horizontal cross braces were attached with 12d nails. The ends of these braces aligned with the ends of the horizontal cross braces on the adjacent sides.
21	The 3-65in diagonal braces were then installed between the 4 horizontal braces.
22	The shore was then rolled over to complete the remaining side. In a controlled environment, blocking can be used under each end of the headers and footers such that the braces on the bottom side can be installed from under the shore. This eliminates the need to roll the shore, reducing the stresses that force the tower out of square.
23	The alignment of the shore was rechecked using the method in steps 16-19, and adjustments made.
24	The final braces were then attached by repeating steps 20 and 21
25	All 4 interior half-gusset plates at the bottom of the shore were attached.
26	The shore was then raised to its upright position by picking up the header end (top) and walking toward the sole end (base).

Figures 4.14 and 4.15 show photos of various stages of the construction process of a laced post shore. Figure 4.16 shows details of the laced post shore.



**Figure 4.14** Fabrication of LP Photographs A) Layout of Main Elements B) Layout of Braces C) Using the First Side as a Guide for the Assembly of the Second Side



**Figure 4.15** Fabrication of LP Photographs A) Assembly of Third Side  
B) Rolling the Shore C) Fully Assembled LP Shore

ITEM	DESCRIPTION	QTY
A	4x4 HEADER	2
B	4x4 SOLE	2
C	2x4 DIAGONAL BRACE - 1ST LEVEL	4
D	2x4 DIAGONAL BRACE TYP	8
E	2x4 HORIZONTAL CROSS BRACE TYP	12
F	5/8 INCH PLYWOOD HALF GUSSET PLATE TYP	8
G	4x4 POST TYP	4
H	2x4 POST WEDGES TYP	8
I	3.25IN - 12d NAIL TYP	156
J	2.5IN - 8d NAILS IN HALF GUSSET PLATE TYP	96

- NOTES:
1. ALL NAILS INSTALLED USING A NAIL GUN THAT CAN FIRE FULL HEADED NAILS.
  2. ALL NAILS ARE VINYL COATED
  3. ALL DIMENSIONAL LUMBER IS UNTREATED, SOUTHERN YELLOW PINE, GRADE NO. 1 OR BETTER
  4. ALL PLYWOOD IS 5/8 INCH CDX

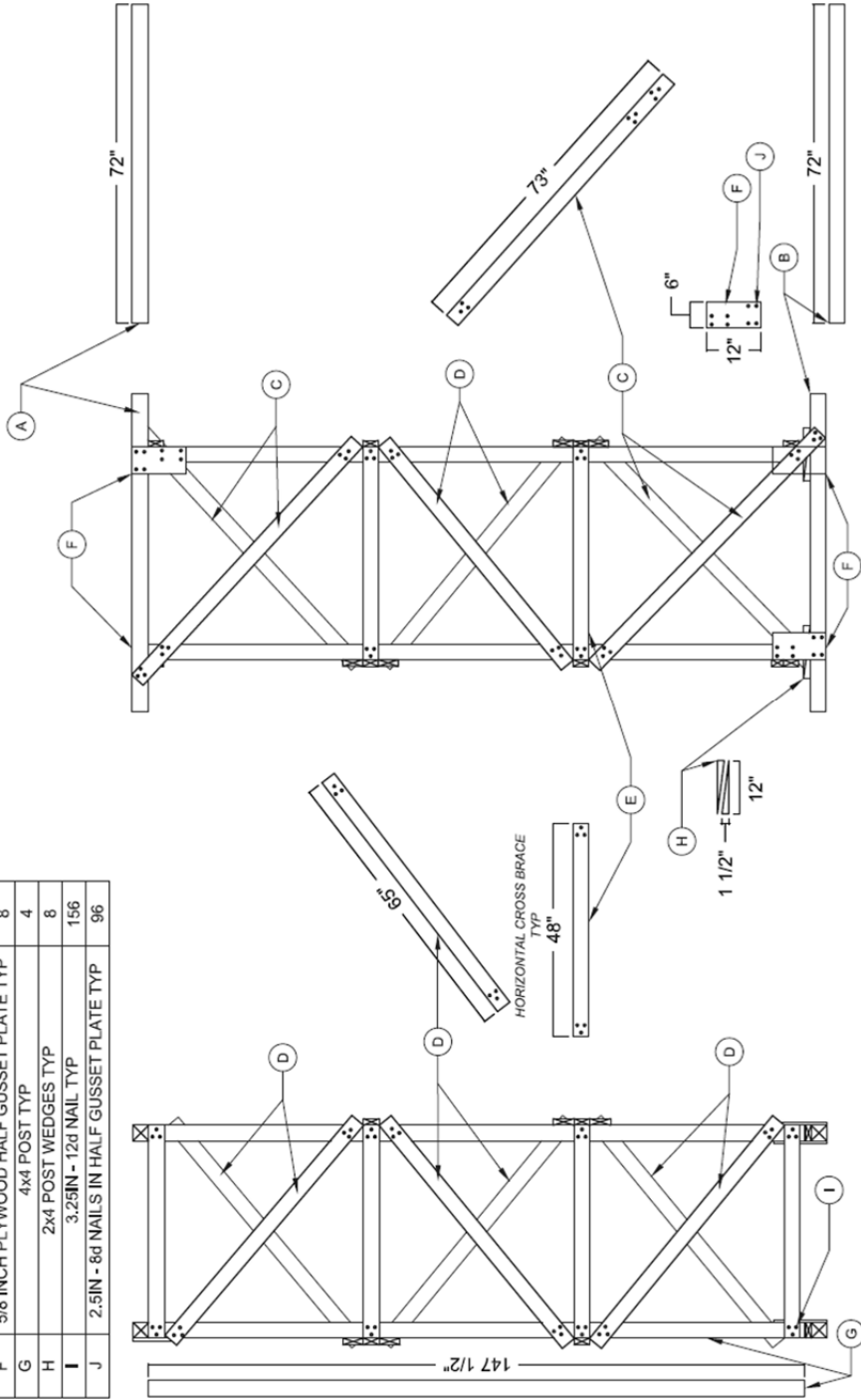


Figure 4.16 Design Detail for Laced Post Shore

#### 4.5.2 Plywood Laced Post Fabrication Process

The process used by John O’Connell and the researchers at FSEL to construct a 13ft tall plywood laced post shore with a footprint of 2ft x 4ft is outlined below:

**Table 4-3** Procedure Used to Construct a Plywood Laced Post Shore

Step No.	Description
1	All 4-4x4 posts were cut to size ( 12’-3.5” ) at the same time. The length of the post was the total height of shore (13ft) minus 8.5in (header + sole + wedges thicknesses).
2	Headers and soles (4x4) were cut to length (4ft) such that there was 12in of overhang. A line was made at 12in from each end to designate the location of the edge of the posts.
3	The first two posts, header, and sole were laid on the floor. The posts were aligned with the header at the 12in marks from the end. One nail for each post was used to toe-nail the post to the header to temporarily secure the alignment of the post.
4	A carpenter’s square was used to square up each post to the header.
5	A double gusset plate (12in x 24in) was cut and attached to both posts and header such that all sides of the plywood were flush with the edges of the 4x4s. This was attached using the 5-8d nailing pattern for each post and the 14-8d nailing pattern for the header. The 14-8d pattern was installed by placing the pair nails on the ends and in the middle first, then placing the two pairs of nails in the middle of the two spaces that were created. This pattern was finish by placing all single nails in the center of the four spaces.
6	Four 24in x 24in plywood braces were cut using 5/8in CDX plywood. One 24in x 24in plywood brace was placed at the desired distance from the top of the header (either 24in or 30in). Post spacing was check to be 24 inches out-to-out before completing the 14-8d nailing on each side of the brace.
7	The lower 24in x 24in plywood brace was then placed at the same distance from the bottom of the sole as in step 6. Post spacing was check to be 24 inches out-to-out before completing the 14-8d nailing on each side of the brace.

**Table 4-3** Procedure Used to Construct a Plywood Laced Post Shore (continued)

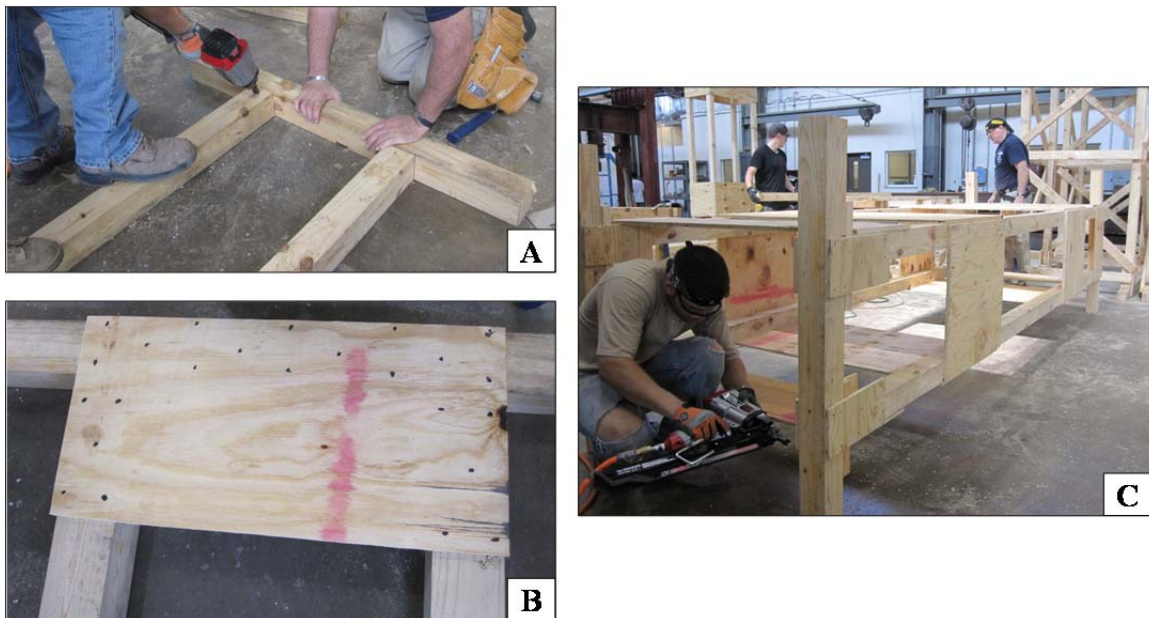
Step No.	Description
8	The sole was aligned with the outer edges of the posts at the 12in marks from the ends. Four pairs of wedges were created by cutting 4-12in long 2x4s in a diagonal fashion through the 3.5in (4in nominal) dimension. One pair of wedges was then centered between the post end and the sole.
9	Each end of each wedge pair was toe-nailed into the sole to hold it in place using 1-8d nail.
10	Eight half-gusset plates (12in x 6in) were cut using 5/8in CDX plywood. One half-gusset plate was attached to each joint of the sole creating a tight fit between the post, wedges and sole. Care was taken to not to fire any of the nails in the 4 and 4 - 8d pattern into the wedges.
11	The completed side of the shore was left on the floor and construction of an identical side was conducted on top of the first. In essence, the first completed side acted as a guide for the second side. All half-gussets and braces were constructed in the same locations as the first.
12	Steps 1-10 were repeated for the second shore side.
13	The two shore sides were then stood up on the ends of their headers and soles. This was conducted such that one side was stood up clockwise and the other counter-clockwise so the braces were on the exterior.
14	Each side was separated from one another by 4ft out-to-out.
15	Four 48in x 12in plywood braces were cut using 5/8in CDX plywood. One 12in x 48in horizontal cross brace was placed at the top, flush under the headers. To allow for adjustment, 1-8d nail was driven into each side at the corner near the header.
16	Another 12in x 48in horizontal cross brace was placed at the bottom approximately 1in of separation from the wedges. To allow for adjustment 1-8d nail was driven into each side at the corner near the wedge.
17	A tape measure was used to measure the distance from the outside corner of each post across the shore in an 'X' to square the entire shore. Once these two distances were equal, the remaining 8d nails were installed in the top and bottom cross braces.
18	Four 24in x 48in plywood braces were cut using 5/8in CDX plywood to serve as the internal brace panels. Two of these intermediate horizontal cross braces were installed using 14-8d nails on each side. The ends of the braces aligned with the ends of the horizontal cross braces on the adjacent sides.



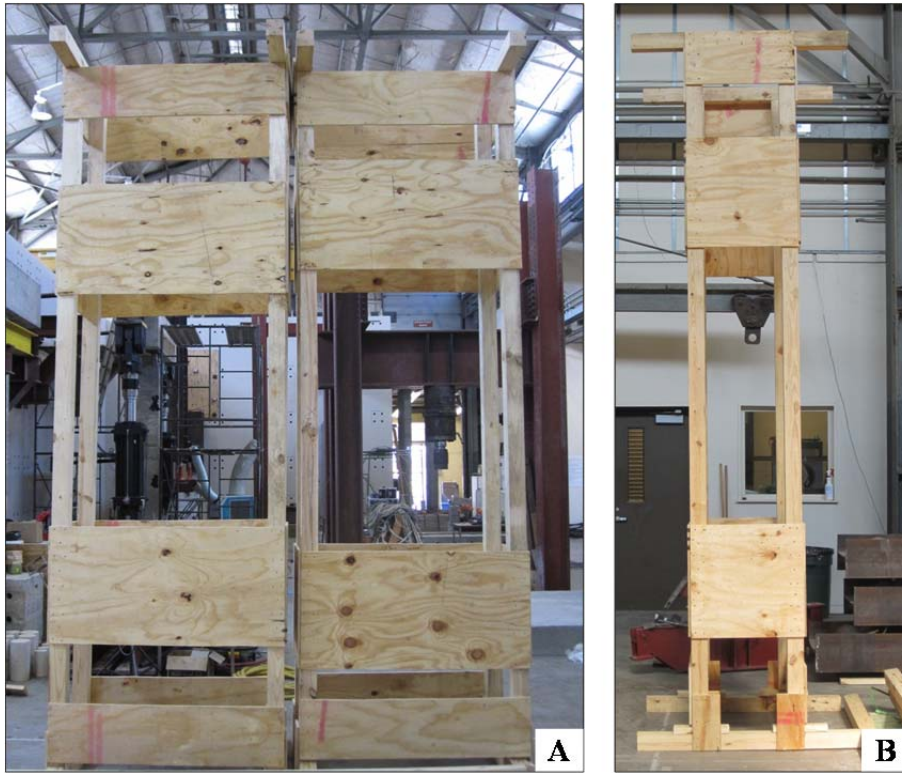
**Table 4-3** Procedure Used to Construct a Plywood Laced Post Shore (continued)

Step No.	Description
19	The shore was then rolled over to complete the remaining side. In a controlled environment, blocking can be used under each end of the headers and footers such that the braces on the bottom side can be installed from under the shore. This eliminates the need to roll the shore, reducing the stresses that force the tower out of square.
20	The alignment of the shore was rechecked using the method in steps 14-17, and adjustments made.
21	The two remaining 24in x 48in intermediate horizontal cross braces were installed using 14-8d nails on each side. The ends of these braces aligned with the ends of the horizontal cross braces on the adjacent sides.
22	All 4 interior half-gusset plates at the bottom of the shore were attached.
23	The shore was then raised to its upright position by picking up the header end (top) and walking toward the sole end (base).

Figures 4.17 and 4.18 show photos of various stages of the construction process of a plywood laced post shore. Figure 4.19 shows details of the plywood laced post shore.



**Figure 4.17** Fabrication of PLP Photographs A) Toe-nail Posts B) Double Gusset Plate  
C) Install Interior Half-Gusset Plates



**Figure 4.18** Completed PLP Shores A) 4ft and 5ft Clear Space PLP  
B) Side View of a 5ft Clear Space PLP

ITEM	DESCRIPTION	QTY
A	4x4 HEADER	2
B	4x4 SOLE	2
C	5/8 IN CROSS BRACE - WIDE SIDE	4
D	5/8 IN CROSS BRACE - NARROW SIDE	4
E	5/8 IN MINOR CROSS BRACE - WIDE SIDE	4
F	5/8 IN MINOR CROSS BRACE - NARROW SIDE	2
G	5/8 IN PLYWOOD HALF GUSSET PLATE TYP	8
H	4x4 POST TYP	4
I	2x4 POST WEDGES	8
J	2.5IN - 8d NAIL TYP	
K	2.5IN - 8d NAILS IN HALF GUSSET PLATE TYP	64

NOTES:  
 1. ALL PLYWOOD IS 5/8 INCH CDX  
 2. ALL DIMENSIONAL LUMBER IS UNTREATED,  
 SOUTHERN YELLOW PINE, GRADE NO. 1 OR BETTER

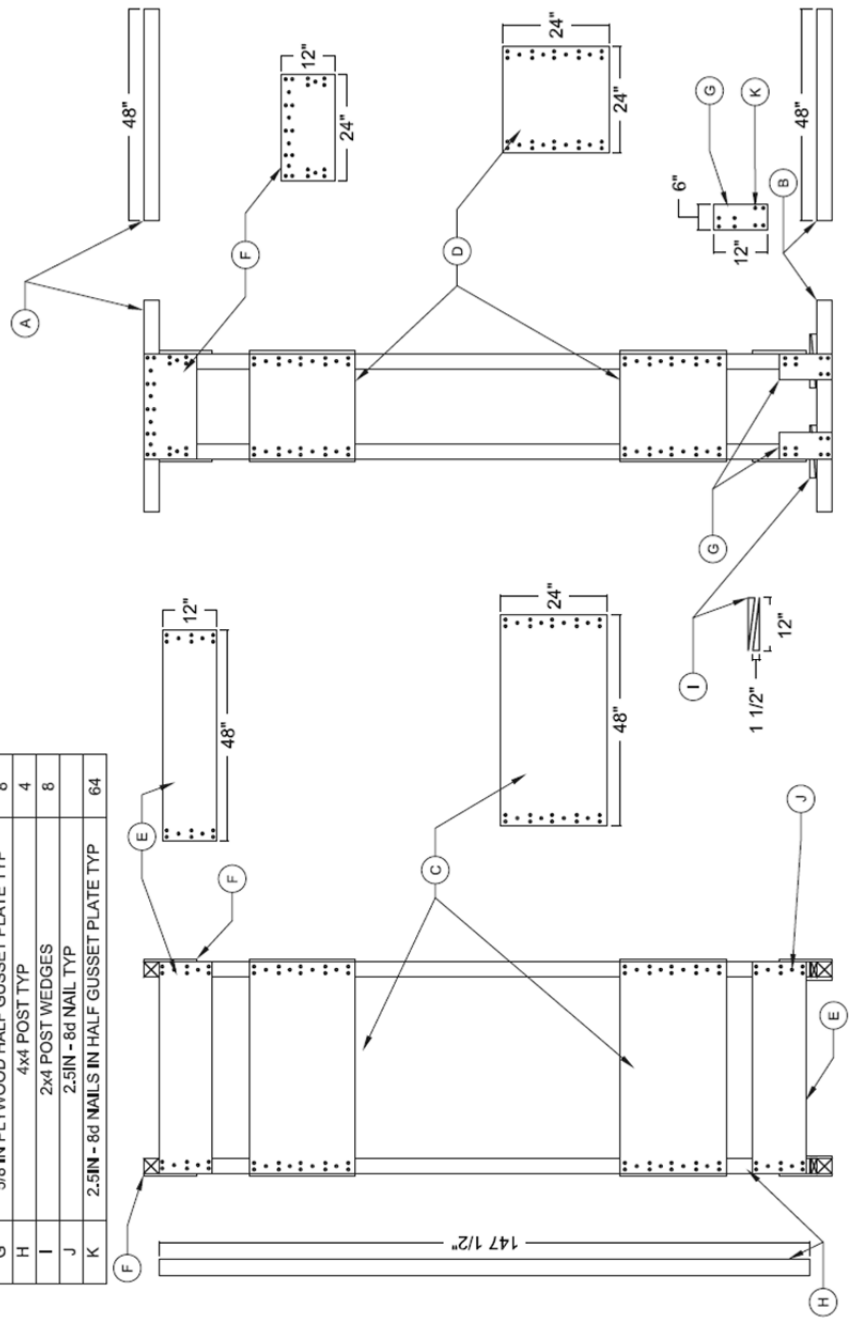


Figure 4.19 Design Detail for Plywood Laced Post Shore

### 4.5.3 Construction Observations

One reason US&R considers the PLP a more effective design is the ease of construction. As experienced during the construction of all 13 shores, the PLP shore required less fabrication time than the LP because it has a fewer number of components that the builder must measure, cut, and assemble. It was also observed that 8d nails were more efficient due to the ease at which the nail gun can drive them. Rarely was the 8d nail not driven the full depth or bent during installation, which was often experienced when using the 12d nails in LP fabrication. Splitting of the wood was also not a concern when using plywood for the PLP shore, whereas splitting of the 2x4 braces is a major issue during installation on a LP shore.

Knots were typically observed to be the point of initial failure in shores during previous US&R testing. In practice, care is taken to limit the number and severity of knots in the four posts of a shore. This is usually carried out using experience and judgment of the trained personnel. However, due to lack of materials and limited time in a disaster scenario, selecting only prime lumber is not always possible. For the fabrication of the 13 test specimens, a limited amount of 4x4s were available for construction. The posts were chosen at the builder's discretion, but knots in the posts were inevitable.

Severe bowing of members was also observed to be a major issue. A roughly 13ft long 4x4 is very susceptible to differential moisture variation which can cause bowing and sometimes twist. The 13 shores were constructed relatively soon after acquiring the lumber, but in the course of both construction and storage some 4x4 members bowed. This change in the 4x4 alignment caused some shores to pull out-of-plumb and even caused bending of plywood brace panels. In response to this observation, all specimens were kept in a similar environment for consistency, and the out-of-plumb of each specimen was measured prior to testing.

*Chapter 5* presents the data and observations collected during the testing phase of the investigation.

## CHAPTER 5

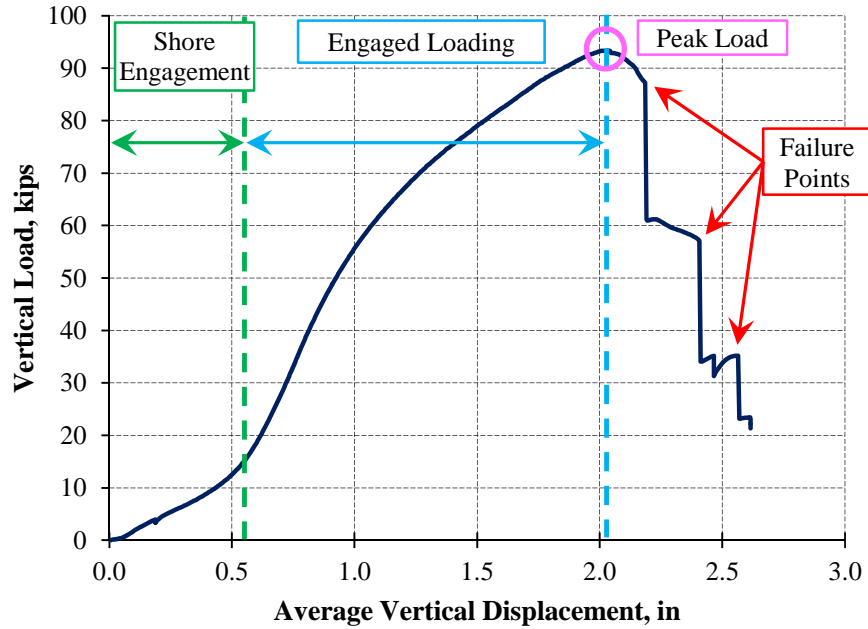
### Test Results

This chapter presents an overall summary of each individual shore test. The results include shore response, maximum load or displacement at failure, load-deflection plot, failure mechanisms and supporting photographs.

As discussed in *Section 3.3*, two methods of data acquisition were utilized. These included built-in instrumentation in each MTS actuator, and external string type linear potentiometers installed at specific locations on the shore. The MTS load cells and LVDT transducers served as the primary source of data collection and were supported using the linear potentiometers. Loads recorded from the two vertical actuators were added to give the total load applied to each shore. Linear displacement data from the two vertical actuators was averaged since both actuators were programmed to move vertically in unison. Prior to testing, the load cells and displacement transducers in the MTS actuators were zeroed when the loading frame was not in contact with the shore. This process introduced a region of initial vertical offset as the load frame was then moved downward to contact the shore. When appropriate, some of the plots included have been adjusted to neglect this initial offset.

Figure 5.1 shows a typical plot of vertical load versus vertical displacement for a shore during testing. Once loading began, the shore typically showed an initial vertical load-deflection response with low, but increasing, stiffness as the tower settled between the concrete slab and floor. This settlement was a result of the shore realigning to provide adequate resistance to the induced load. Since the shores were built on their sides, posts connections were made without a significant force facilitating a tight connection. Therefore, under loading, the posts shifted until full bearing against the headers and wedges was achieved. Another small component of this behavior was the near perpendicular to grain loading response of the fuses. This results in a measureable amount of bearing deformation (crushing) of the fuses. However, this additional source

of deformation was not as dominant as the engagement of the posts. This alignment of members and engagement of connections is seen by the region of large displacement under small loads in Figure 5.1.



**Figure 5.1** Typical Vertical Load-Displacement Plot

After the initial region of low stiffness, the slope of the load-displacement curve dramatically increases. This is a result of all elements becoming fully engaged and resisting the vertical load (Engaged Loading Region). A peak load was attained at the climax of this engaged loading region. The first failure, generally characterized as a failure in one of the four posts, is typically the first point of extreme load reduction (shown in red). This load reduction occurs almost instantaneously with very little vertical displacement until the shore attains a new value of resistance. This region is only clearly displayed when using displacement-controlled loading, because the applied load is reduced while vertical displacement is continued. Once this new stiffness was attained, large amounts of displacement are seen at relatively the same load until another failure

occurred.

These progressive step-like failures are very characteristic of a displacement-controlled loading system on a structure with main supporting members. Force-controlled loading results in rapid failure after the peak load because the applied load is not reduced (See specimen 4). The following sections contain load-displacement plots with similar characteristic regions as those displayed in Figure 5.1. Further discussion and analysis is presented in *Chapter 6: Observations and Analysis*.

## 5.1 TEST SPECIMEN 1

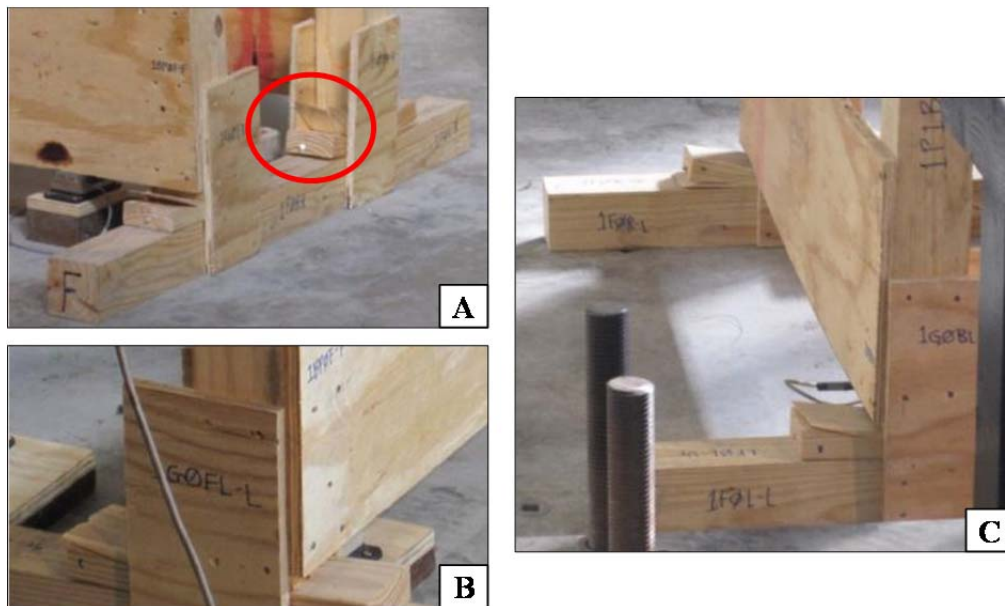
Details regarding the test setup and the condition of the specimen prior to testing are included in Table 5-1 below.

**Table 5-1** Details for Test Specimen 1

<b>Specimen #1</b>	
Specimen Type	PLP* (4ft CS)
Load Scenario	[A] Vertical Only, Displ-Control
Loading Rate	0.2 in/min
Lateral Braces Used	NO
Avg. Initial Out-of-Plumb (Alignment of Top rel. to Bottom)	
L-R	3.5in L
F-B	1.6in F

Specimen 1 was a plywood laced post shore with a 4-ft clear spacing between the intermediate braces. This is not the specified clear space in the USACE FOG, but was tested to use as a comparison to the 5ft typical detail. Lateral braces, described in *Chapter 3*, restricted the headers and footers of the shore from sliding during lateral load scenarios. For this specimen, lateral braces were not used. The relative plumb of the header to the footer was measured for each specimen in the left to right (L-R) direction and the front to back (F-B) direction. This specimen had an average out-of-plumb of 1.6in. in the 2ft dimension, and a considerable average out-of-plumb to the left in the 4ft dimension. This out-of-plumb was visibly noticeable prior to testing.

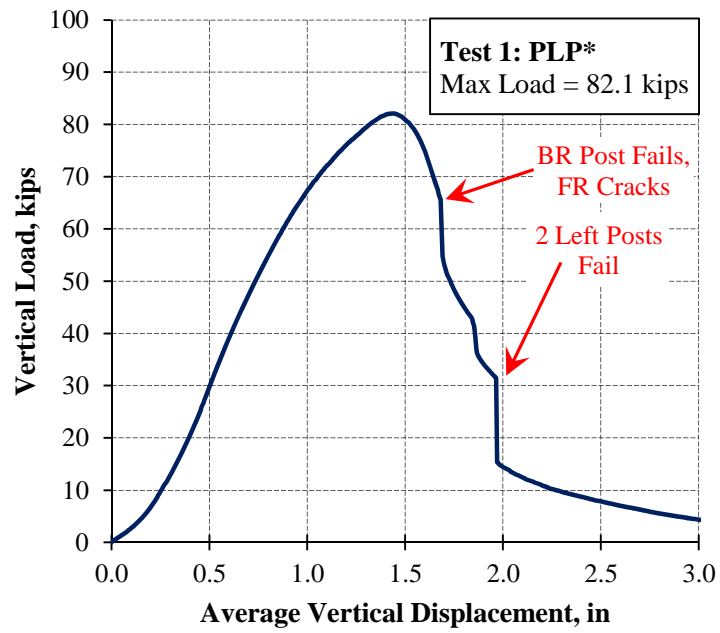
During loading, audible sounds of the wood creaking and cracking were heard from periods of low loads (20-30kips) up to failure. These noises intensified at loads of around 70kips and above. Also visibly noted during testing was the cupping action of some of the wedges. In particular, the two sets of wedges on the right side of the shore cupped to a greater degree than the two sets on the left. This cupping action progressed from approximately 50kips to failure. Figure 5.2 shows the performance of the wedges.



**Figure 5.2** Test 1 Wedge Performance A) Right Side Cupping B) No cupping at Front Left C) Minor Cupping of Back Right

Prior to failure, all four posts began to bow outward towards the front. The first failure occurred at a knot in the back right post at approximately the midpoint between the intermediate braces at a total vertical load of 65kips. The front right post also cracked around a spike knot just above the lower intermediate brace at 65kips and progressively split as loading continued. At approximately 32kips, the two left posts simultaneously failed at knots. This load progression is presented using the load-displacement curve in Figure 5.3. Photographs of the failures are also provided.





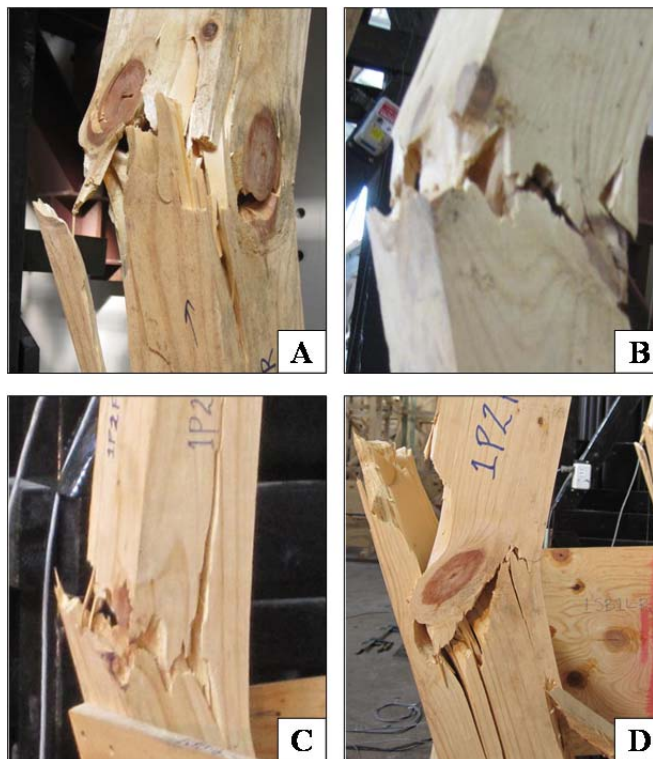
**Figure 5.3** Load-Displacement Curve for Specimen 1



**Figure 5.4** Test 1 A) First Failure and Bowing of Posts B) All Post Failures

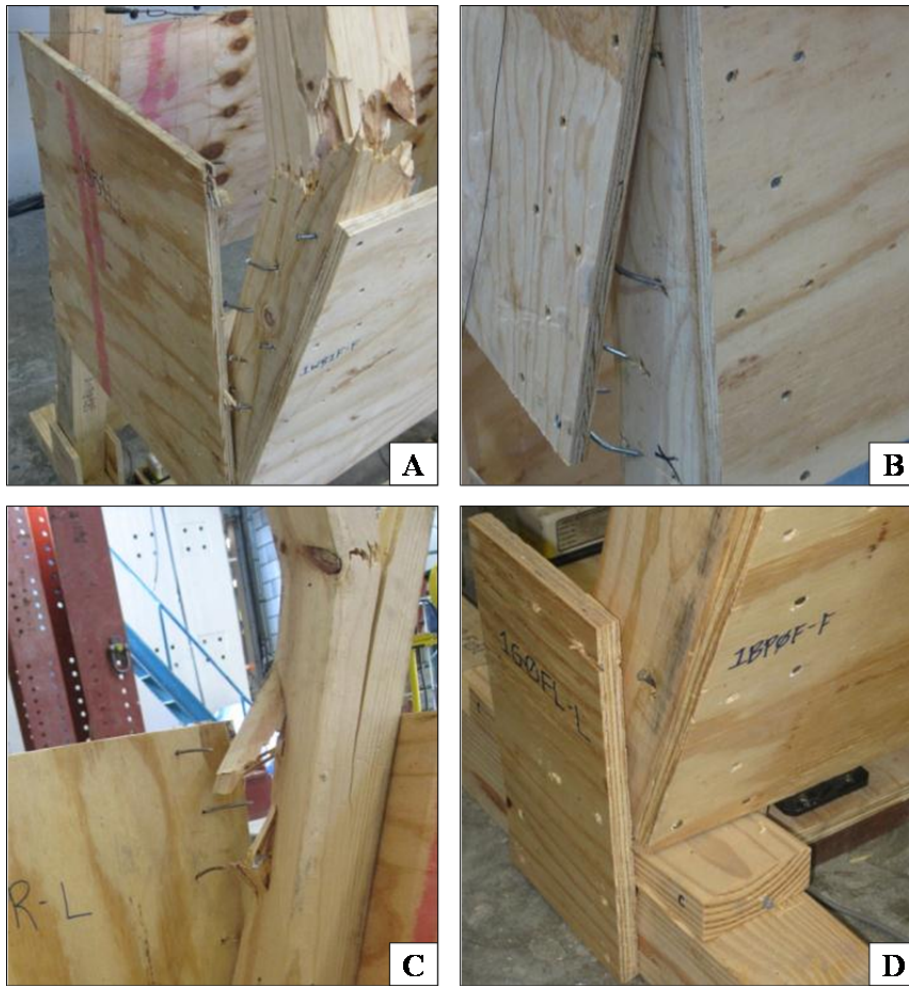


**Figure 5.5** Final Failed Condition at the End of Test 1



**Figure 5.6** Post Failures A) Back-Left B) Back-Right  
C) Front-Left D) Front-Right

All brace failures were at the connections, not within the plywood section. Failure of the braces consisted of nail withdrawal in the direction of the post bowing. In some cases the nails withdrawal from the posts and in others the nails pulled through the plywood cross-section. Connections of the half-gusset plates also pulled through as the posts rotated about the wedges. Figure 5.7 shows the different types of connection failures in shore 1.



**Figure 5.7** Connection Failures A) Pull Through B) Pullout C) Post Splintering D) Half-Gusset Rotation and Pull Through

## 5.2 TEST SPECIMEN 2

Details regarding the test setup and the condition of the specimen prior to testing are included in Table 5-2 below.

**Table 5-2** Details for Test Specimen 2

Specimen #2	
Specimen Type	PLP 5ft CS
Load Scenario	[A] Vertical Only, Displ-Control
Loading Rate	0.2 in/min
Lateral Braces Used	NO
Avg. Initial Out-of-Plumb (Alignment of Top rel. to Bottom)	
L-R	1.5in L
F-B	1.8in F

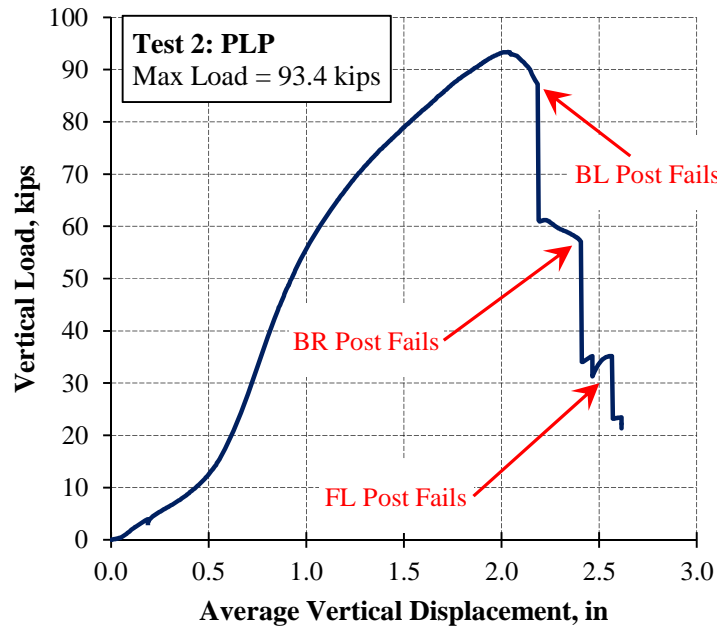
During testing, audible creaking and cracking of wood could be heard starting at 20kips and continuing to failure. These noises intensified in magnitude and frequency as the applied load approached the peak value. Cupping of the wedges initiated at around 65kips and widened as the test progressed. Cupping of each set of wedges was very uniform and consistent between all four sets. Figure 5.8 shows the performance of the wedges.



**Figure 5.8** Test Specimen 2 Wedge Cupping

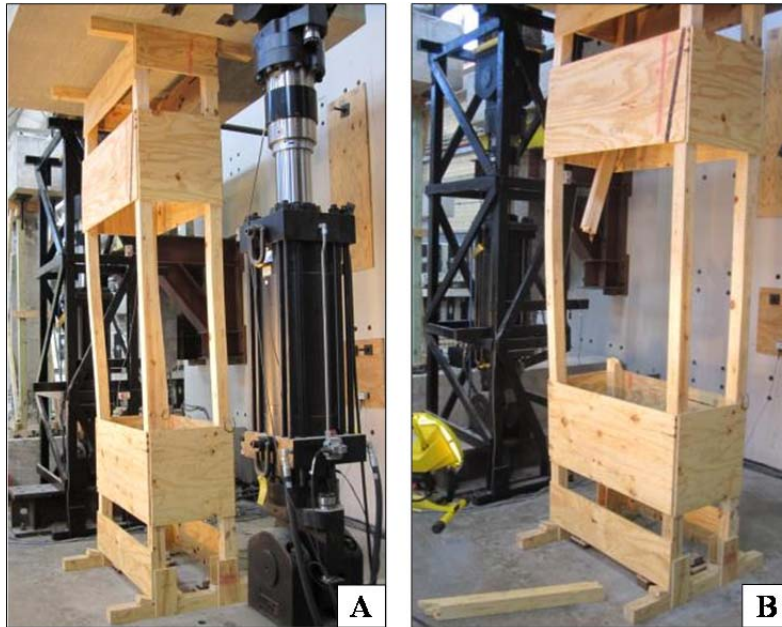


At 85kips, the two left posts were visibly bent in an ‘S’ shape, while the right posts remained relatively vertical. After the peak load of 93.4kips was reached, the back left post failed completely through the cross section in two locations, ejecting a roughly three foot long section. The back right post buckled at approximately 57kips in multiple locations, followed by the front left post at approximately 34kips. The load-displacement response is shown in Figure 5.9.

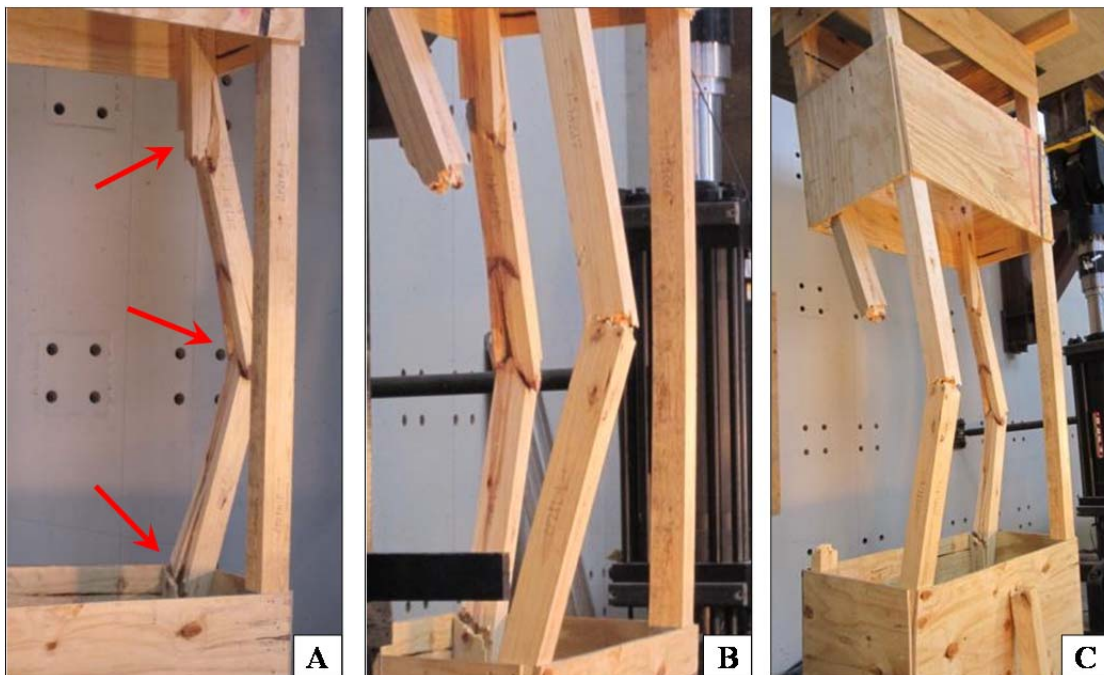


**Figure 5.9** Load-Displacement Curve for Specimen 2

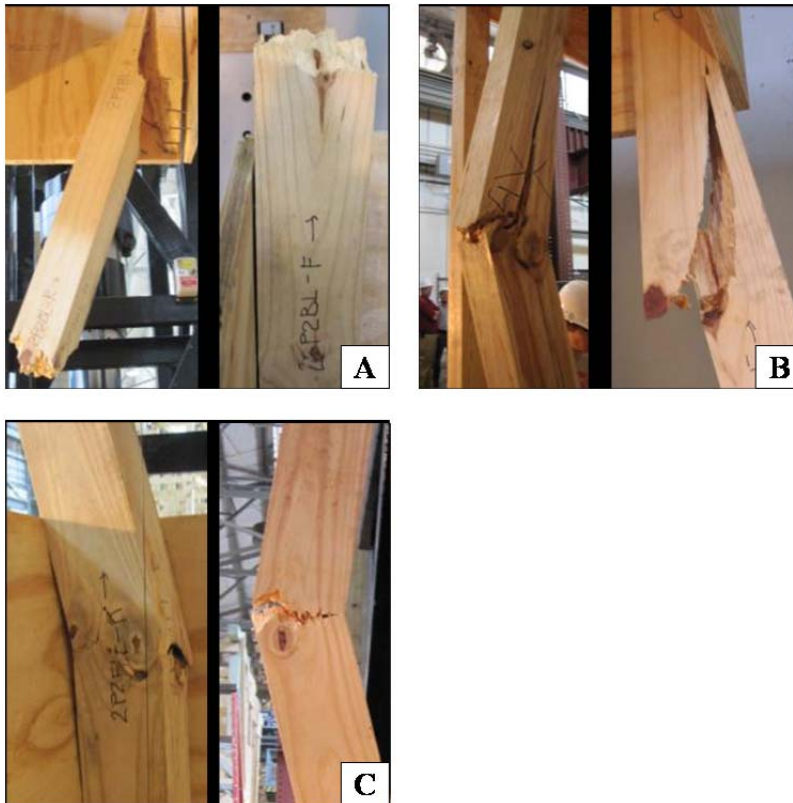
Photographs of each post failure are included in the following figures. It is interesting to note that all three failures were unique and did not follow the same one-directional buckling failure as was seen in test 1. Failures 1 and 2 included multiple points of fracture and the failure planes were 90 degrees from one another.



**Figure 5.10** Specimen 2 A) Left Post Buckling B) First Failure



**Figure 5.11** Specimen 2 A) Second Failure B) Third Failure C) End of Test Condition



**Figure 5.12** Post Failures A) Back Left B) Back Right C) Front Left

The three failures failed in multiple locations, within the clear spacing of the post between braces, and a secondary failure within the brace region. This displays the presence of high stresses within the interface region of the braces and clear spans of the post. Only minor withdrawal of the 8d nails in the half-gusset plates and plywood braces was documented. These cases are shown in Figure 5.13.



**Figure 5.13** Samples of Minor Pullout from Specimen 2

### 5.3 TEST SPECIMEN 3

Details regarding the test setup and the condition of the specimen prior to testing are included in Table 5-3 below.

**Table 5-3** Details for Test Specimen 3

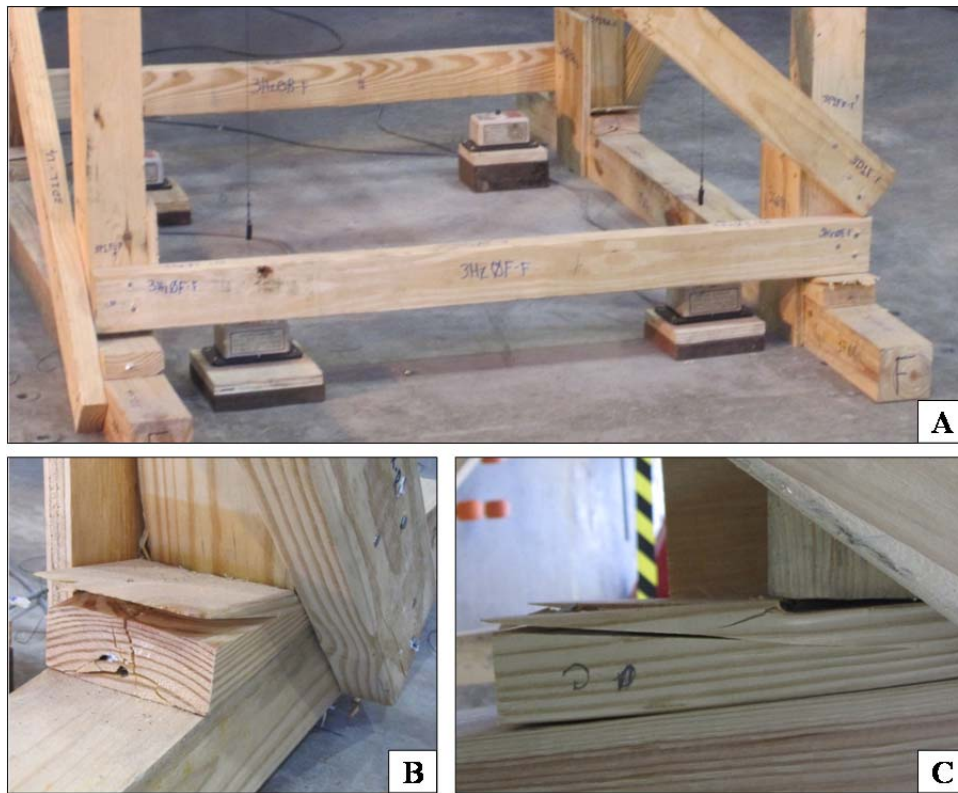
Specimen #3	
Specimen Type	LP
Load Scenario	[A] Vertical Only, Displ-Control
Loading Rate	0.2 in/min
Lateral Braces Used	NO
Avg. Initial Out-of-Plumb (Alignment of Top rel. to Bottom)	
L-R	1.6in L
F-B	0.5in F

As noted in Table 5-3, specimen 3 was relatively plumb in the front-to-back direction which was primarily the direction of buckling in the first two specimens. However, a considerable out-of-plumb of the top towards the left was noticeable. As discussed in *Chapter 4*, the LP towers were built with a 4ft x 4ft footprint in contrast to



the PLP 2ft x 4ft rectangular design.

During testing, creaking of the wood could be heard as early in the loading process as 17kips, and increased in frequency and magnitude at loads above 50kips. At 50kips, cupping of the back right wedge was noticeable, and cupping of the back left wedge was slightly noticeable, but did not progress a significant amount during loading. Cupping of the front two pairs of wedges was noticeable around 75kips. The performance of the wedges is shown in Figure 5.14.

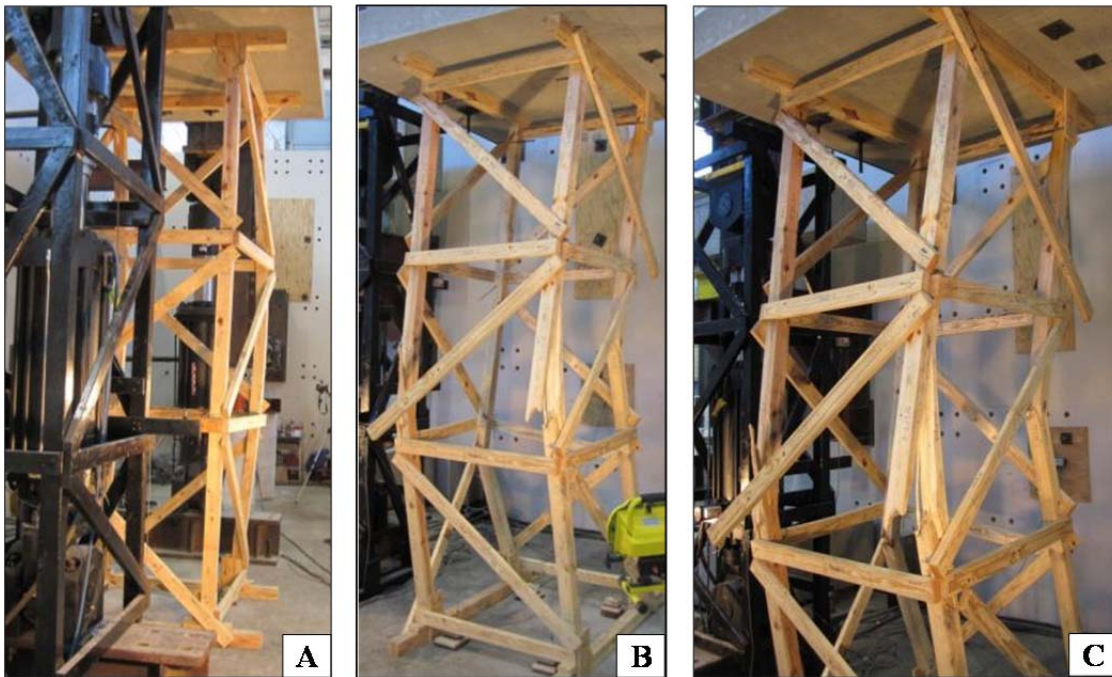


**Figure 5.14** Specimen 3 Wedge Photos A) Cupping at Approx. 60 kips B) Back Right Wedge at End of Test C) Front Left Wedge Cupping and Post Bearing

After reaching the peak load of 85.7 kips, the front right and back right posts began to deflect forwards to a significant degree. This action dramatically reduced the stiffness of the shore as the two posts began to buckle. At approximately 66 kips, both

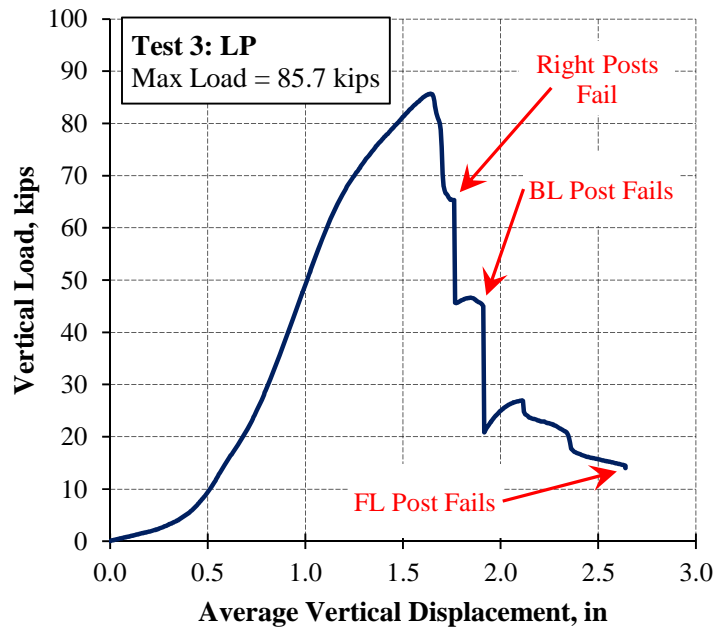
right posts buckled simultaneously. The front right post failed on the tension face, and then split longitudinally up the post around the inner radial fibers of the post. The back left post buckled after the level 1 horizontal brace pulled out from the back right post at approximately 46 kips. The final post failed just after the conclusion of the test; the applied load was 16 kips when the test was ended.

Bowing of the right posts prior to failure and the failures of all four posts are displayed in Figure 5.15. The buckling plane of the third failure (back left) was to the left whereas the buckling planes of the other three posts were towards the front, as seen in Figure 5.15-B.

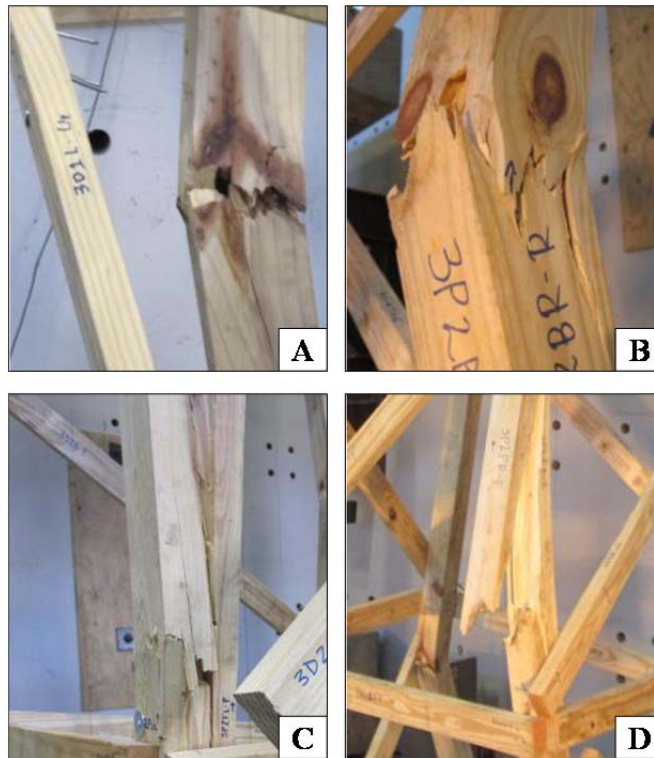


**Figure 5.15** Specimen 3 A) Bowing of Right Posts before Failure B) End of Test Condition C) Close-up of All Four Post Failures

The load-displacement plot is shown in Figure 5.16. Figure 5.17 shows a close-up view of each of the four post failures. Each failure occurred at a knot in the post.

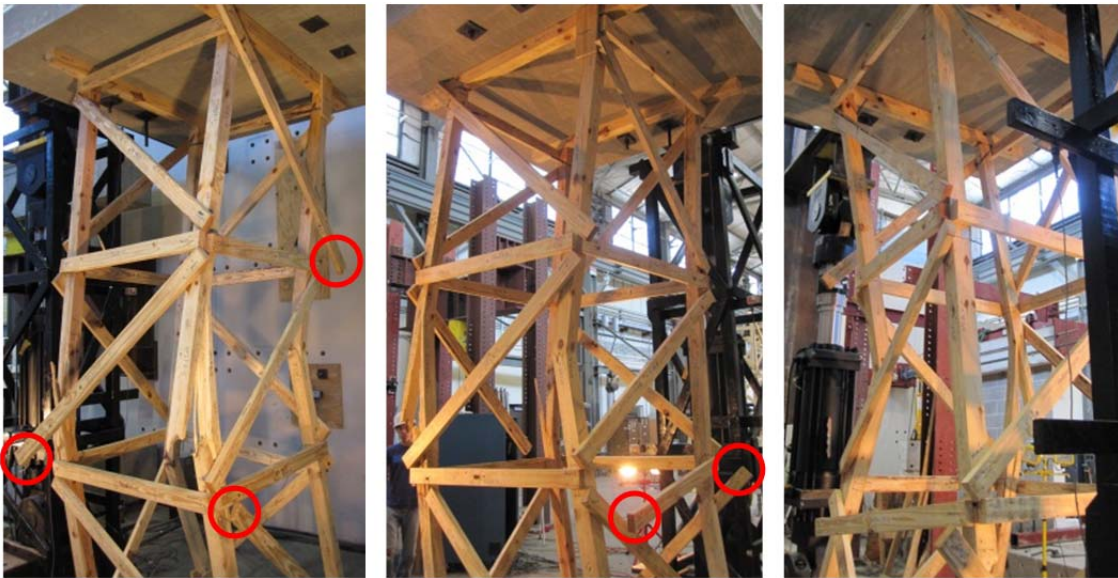


**Figure 5.16** Load-Displacement Curve for Specimen 3



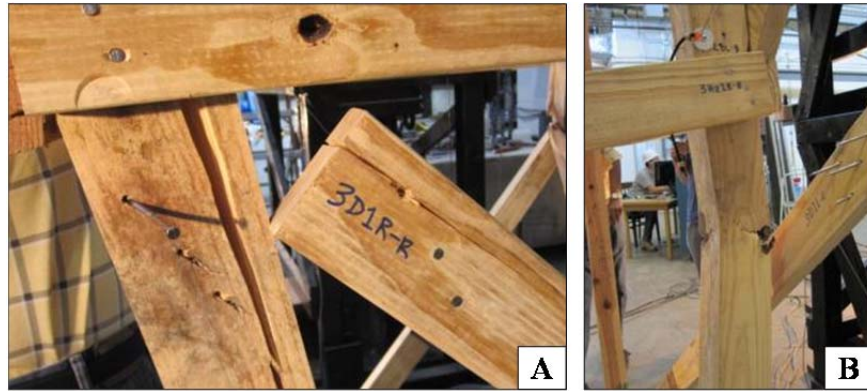
**Figure 5.17** Post Failures A) Back Left B) Back Right C) Front Left D) Front Right

Multiple 2x4 brace connections failed during the extent of the test. Connection failures generally consisted of nail pullout due to splitting of the brace, or nail withdrawal from the post. The five connections that failed were: first level diagonal on left side (3D1L), first level diagonal on right side (3D1R), first level horizontal on back (3Hz1B), second level diagonal on front (3D2F), third level diagonal on right (3D3R). A partial nail withdrawal from the post was also observed on the third level diagonal on the left side (3D3L). The following photographs illustrate the locations of the failed braces and close-up images depicting a typical pullout scenario.



**Figure 5.18** Photographs of the Five Brace Connection Failures at End of Test





**Figure 5.19** Connection Failure Photographs A) Nail Pullout from Split Brace B) Nail Pullout from Post

#### 5.4 TEST SPECIMEN 4

Details regarding the test setup and the condition of the specimen prior to testing are included in Table 5-4 below.

**Table 5-4** Details for Test Specimen 4

Specimen #4	
Specimen Type	LP
Load Scenario	[A*] Vertical Only, Load-Ctrl
Loading Rate	10 kips/min Total
Lateral Braces Used	NO
Avg. Initial Out-of-Plumb (Alignment of Top rel. to Bottom)	
L-R	1.3in L
F-B	0.1in B

This shore was relatively plumb in the front-to-back direction and averaged over an inch out-of-plumb in the left-to-right direction. This test was administered using load-controlled loading at a rate of 5kips/min/actuator for a total loading rate of 10kips/min. Once initial failure was reached, loading was not reduced until complete failure occurred.

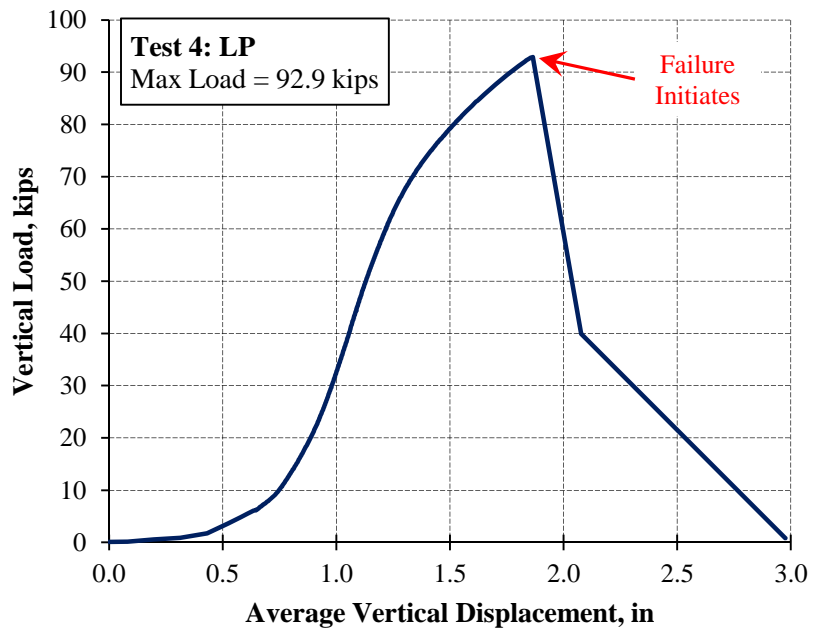
There were relatively no audible wood noises heard during testing prior to 70kips. These cracking and creaking sounds intensified from 85kips until failure. Cupping of the

wedges was very minor throughout the duration of the test. Only the back left set of wedges appreciably cupped, as shown in Figure 5.20.

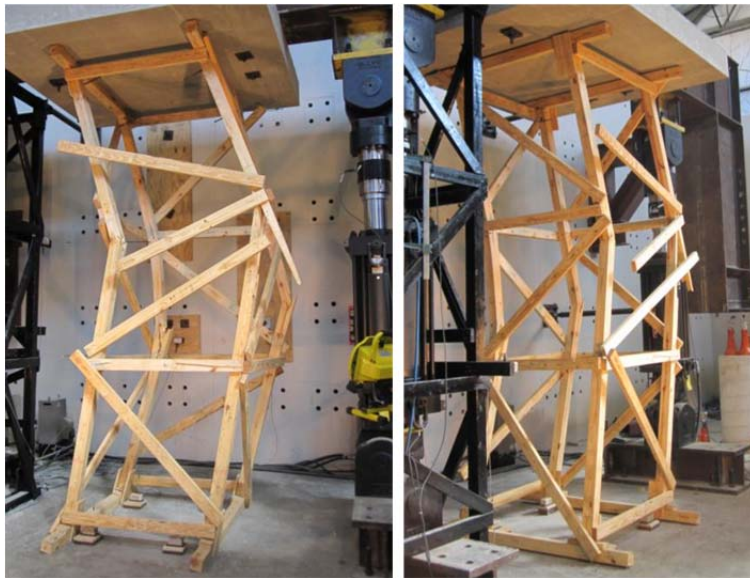


**Figure 5.20** Specimen 4 Wedges A) Wedges at Failure B) Back-left Wedge Cupping

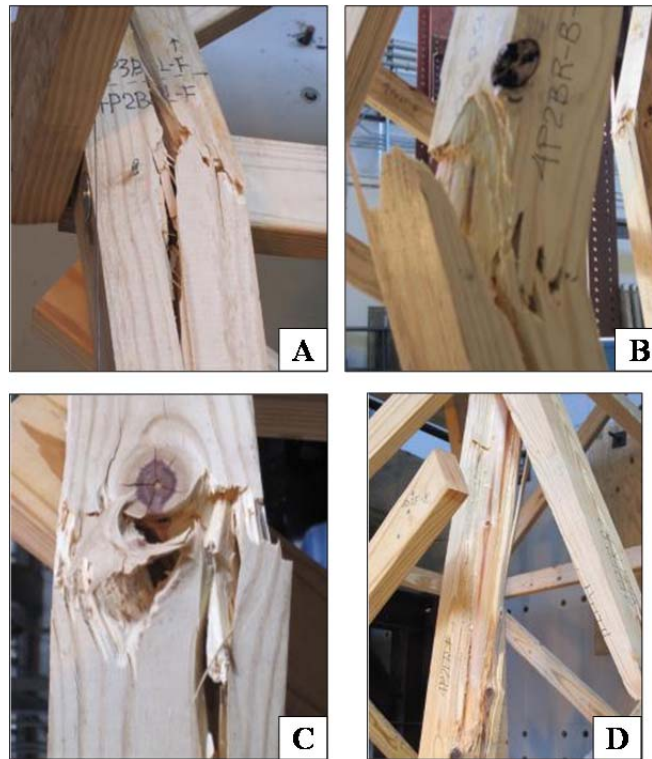
As the peak load was reached, the two back posts buckled to the right, followed closely by the buckling of the front two posts. The failure of all four posts occurred in approximately one second, in contrast to the progressive failures of the displacement-controlled tests. The load-displacement plot and post-failure photographs of test 4 are included in the following figures.



**Figure 5.21** Load-Displacement Curve for Specimen 4



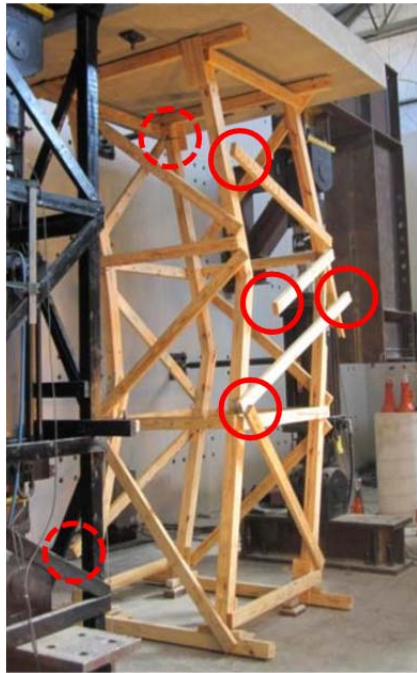
**Figure 5.22** Specimen 4 Failure Photographs at Conclusion of Test



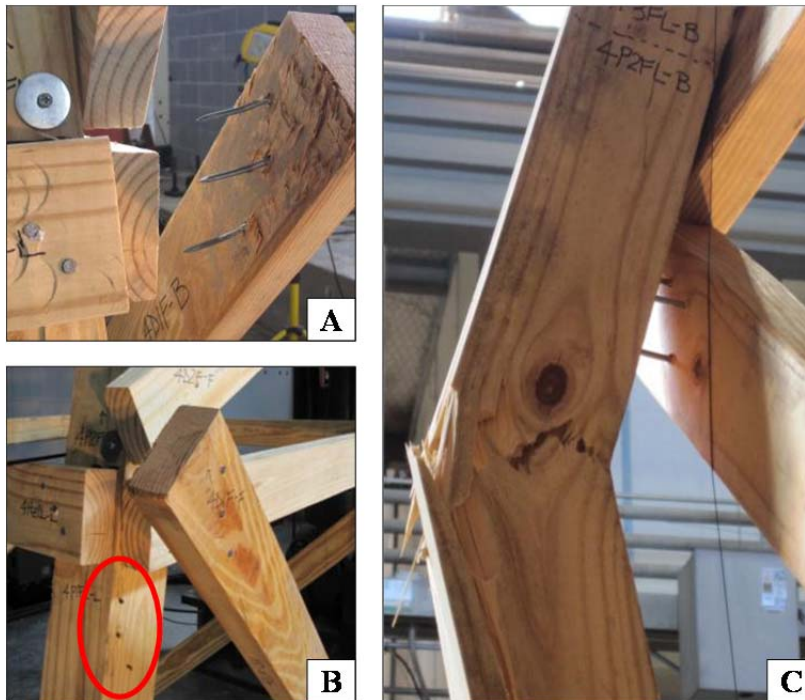
**Figure 5.23** Post Failures A) Back-Left B) Back-Right C) Front-Left D) Front-Right

With the buckling action to the right, the majority of the braces on the front and back sides failed at their connections. All connection failures were characterized by nail withdrawal from the post, and did not include nail pull through by means of a split in the 2x4 brace, as was seen in Specimen 3. Complete brace connection failures included all of the diagonal braces on the front face, the second level horizontal brace on the front (4Hz2F), level 1 diagonal on the back (4D1B) and level 3 diagonal on the back (4D3B). Partial nail withdrawal locations were also observed on many of the other braces including those on the left and right sides. Figure 5.24 shows the six complete connection failure locations, and Figure 5.25 presents examples of these failures.





**Figure 5.24** Locations of Connection Failures on Specimen 4



**Figure 5.25** Specimen 4 Connection Failures A) Nail Pullout B) Nail Pullout Holes C) Partial Pullout on Left Side

## 5.5 TEST SPECIMEN 5

Details regarding the test setup and the condition of the specimen prior to testing are included in Table 5-5 below.

**Table 5-5** Details for Test Specimen 5

<b>Specimen #5</b>	
Specimen Type	PLP 4ft CS
Load Scenario	[B] Cyclic Loading
Loading Rate	3.5in/min
Lateral Braces Used	YES
Avg. Initial Out-of-Plumb (Alignment of Top rel. to Bottom)	
L-R	2.3in L
F-B	0.4in F

The cyclic lateral motion for specimen 5 was in the left-to-right direction, therefore the average 2.3in. out-of-plumb in the left direction dramatically impacts the relative lateral displacement. At the cyclic amplitude of 2in. to the left, the shore headers are actually 4.3in. offset from the footers. At 2in. to the right, the shore is essentially plumb. The effects of this initial offset are magnified for the 4in. lateral cycles.

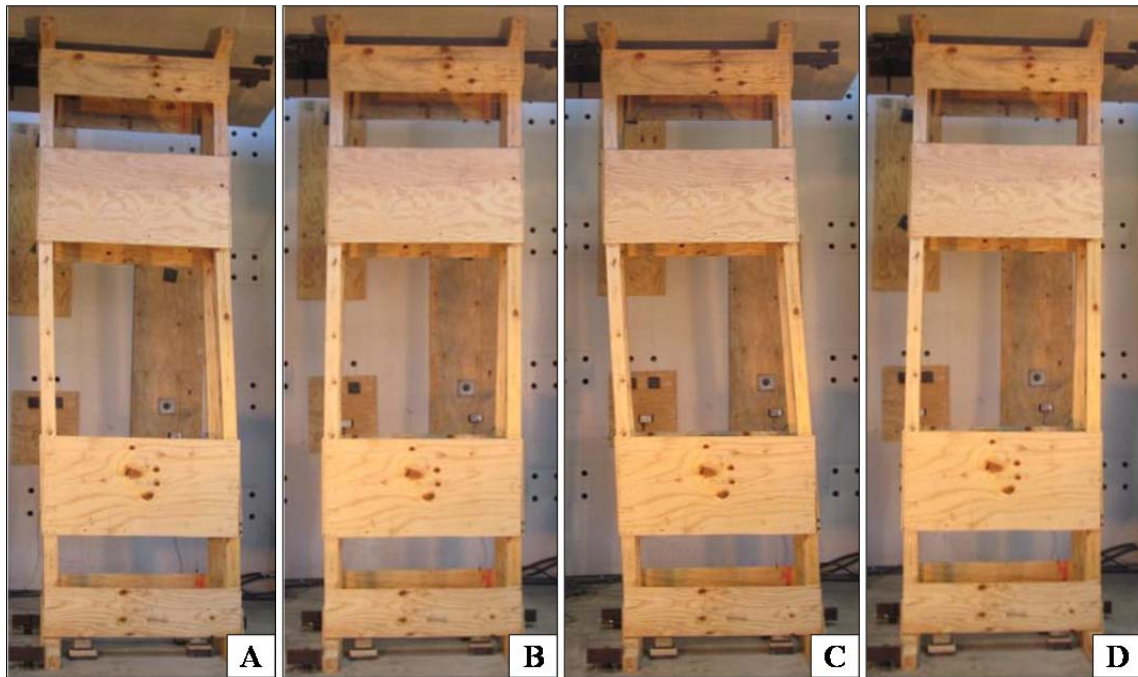
Audible creaking and cracking sounds were heard throughout the test, primarily during the first cycle of each loading scenario. The shore withstood all four levels of cyclic loading, and was then tested to failure under vertical loading only. Audible sounds were also heard with increasing intensity during the vertical loading phase.

Wedge cupping was relatively absent throughout the entire loading sequence. Longitudinal wedge splitting was observed, but vertical cupping was not witnessed. Figure 5.26 shows the condition of the wedges at the conclusion of the test.



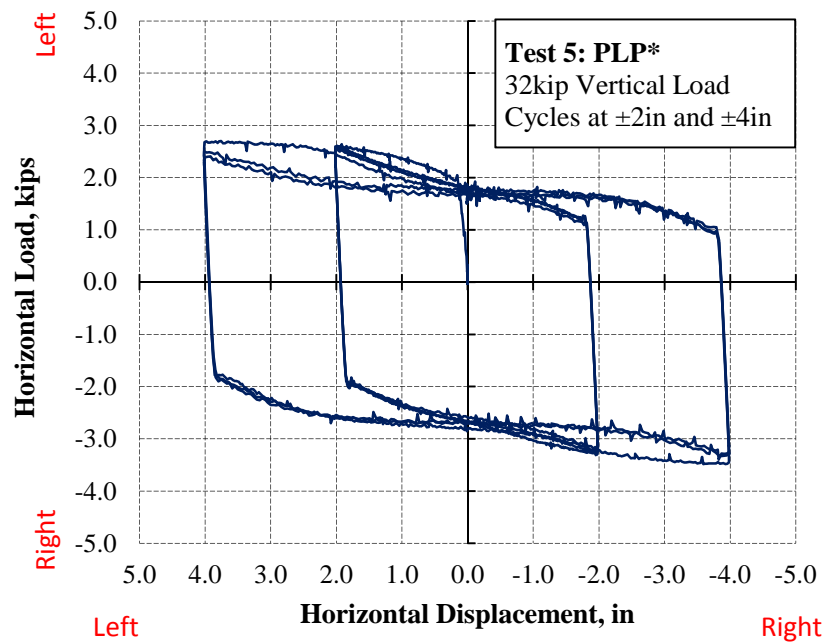
**Figure 5.26** Photographs of Wedges at the End of Test

A series of four photographs showing the four lateral displacement amplitudes is provided in Figure 5.27. Double curvature in the posts can be seen as the top of the shore moved laterally while maintaining a level loading head. Steel lateral braces installed at the headers and soles prevented the shore from sliding during testing.

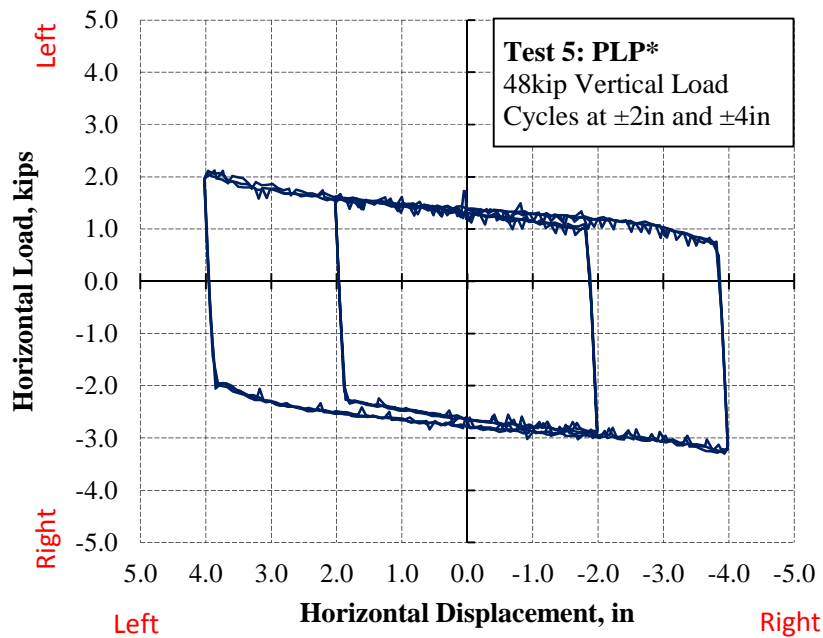


**Figure 5.27** Specimen 5 Displacement Phases A) 2in Left B) 2in Right C) 4in Left  
D) 4in Right

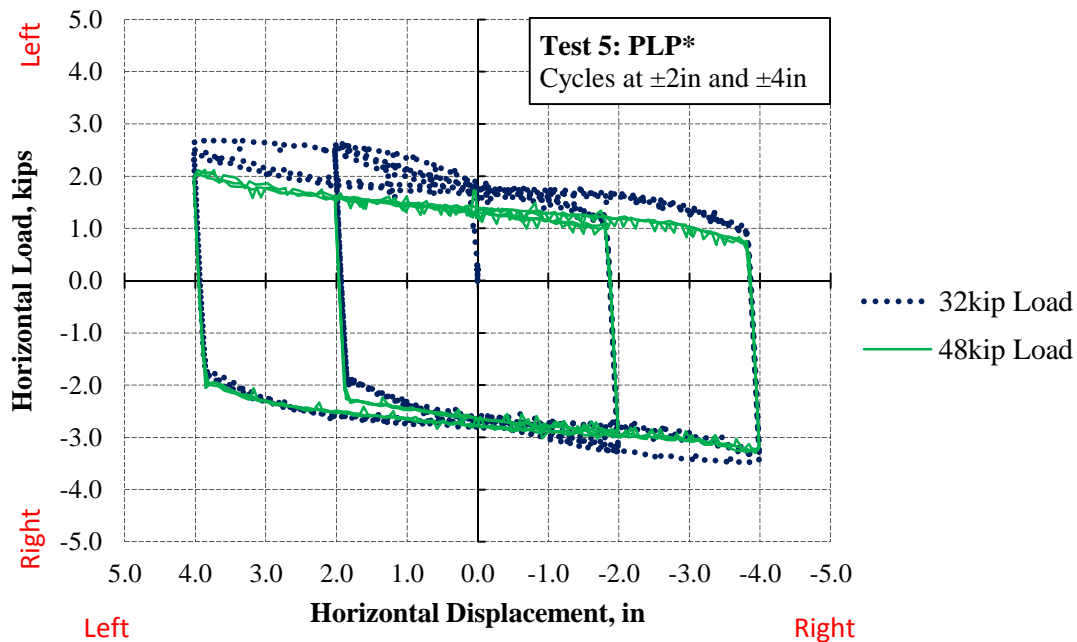
The lateral load-displacement plot for the cyclic loading are presented in Figures 5.28 to 5.30. The two sets of cycles under 32kip and 48kip sustained loads are presented in separate plots, as well as one plot containing all cycles for comparison. Note the similar shapes of the plots and relative loading values. Positive values represent movement and loading of the shore to the left, negative values to the right.



**Figure 5.28** Horizontal Load-Displacement Plot with 32kip Vertical Load



**Figure 5.29** Horizontal Load-Displacement Plot with 48kip Vertical Load

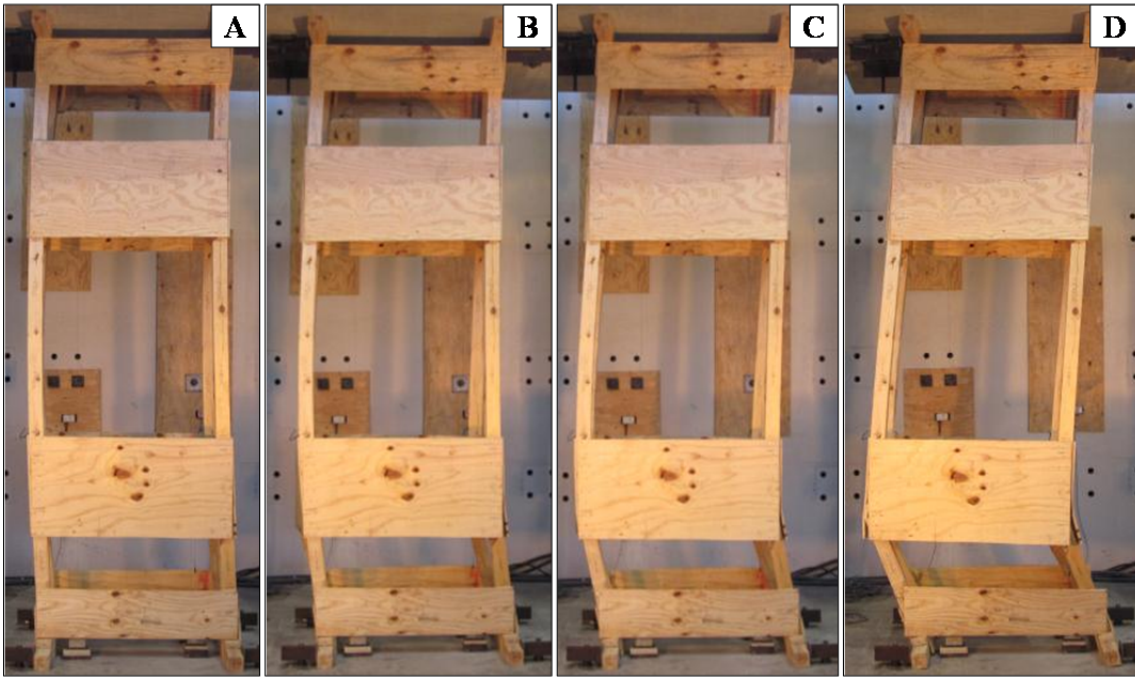


**Figure 5.30** Comparison of Horizontal Load-Displacement Cycles for each Vertical Load

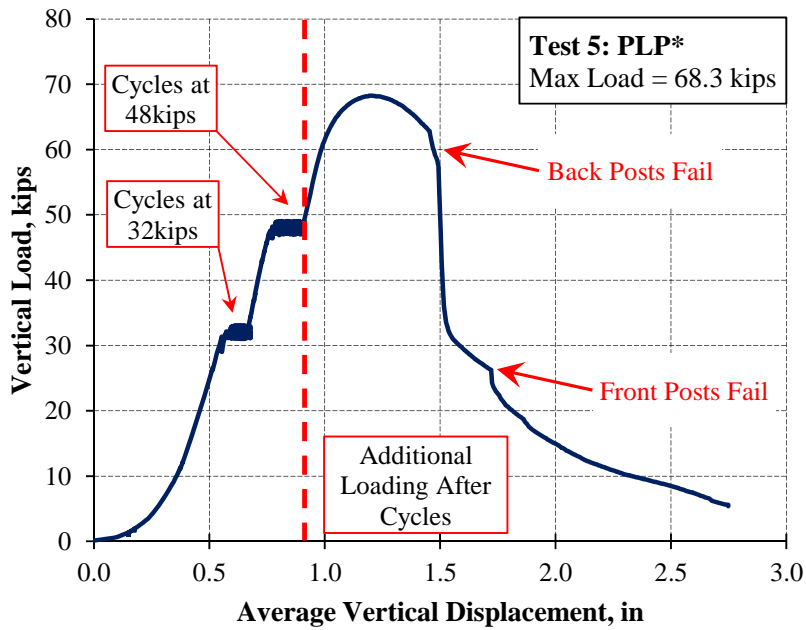
Specimen 5 endured all four scenarios of cyclic loading using 32kip and 48kip sustained vertical loads. Upon completion of the final cycle, the shore was brought back to the neutral position (pre-test position) and loaded vertically to failure using displacement-control.

Rather than bending in double curvature as was seen during the lateral displacement phase of the test, the posts buckled in single curvature under the increasing vertical load. At approximately 62kips, both back posts failed at relatively the same time in the region of the lower intermediate plywood brace. The front two posts failed around 26kips in the same direction as the back two posts. Figure 5.32 shows the progressive failure and Figure 5.31 shows the vertical load-displacement plot for the entire duration of the test. Vertical loading conducted after the completion of the cyclic phase is shown to the right of the dashed red line.



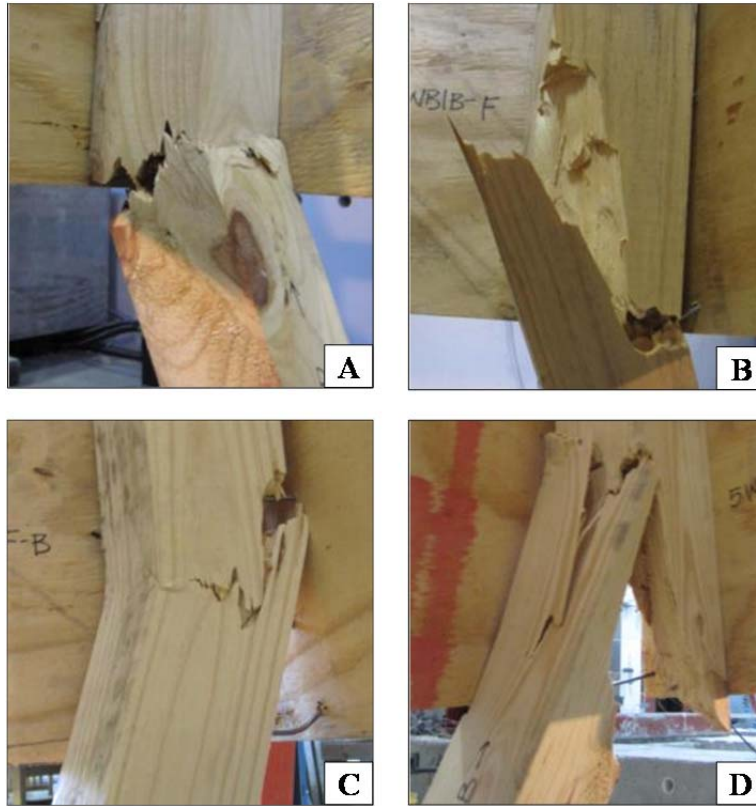


**Figure 5.32** Specimen 5 Failure Progression A) Bowing of Posts B) Back Posts Fail C) Front Posts Fail D) Final Condition at End of Test



**Figure 5.31** Load-Displacement Curve for Specimen 5

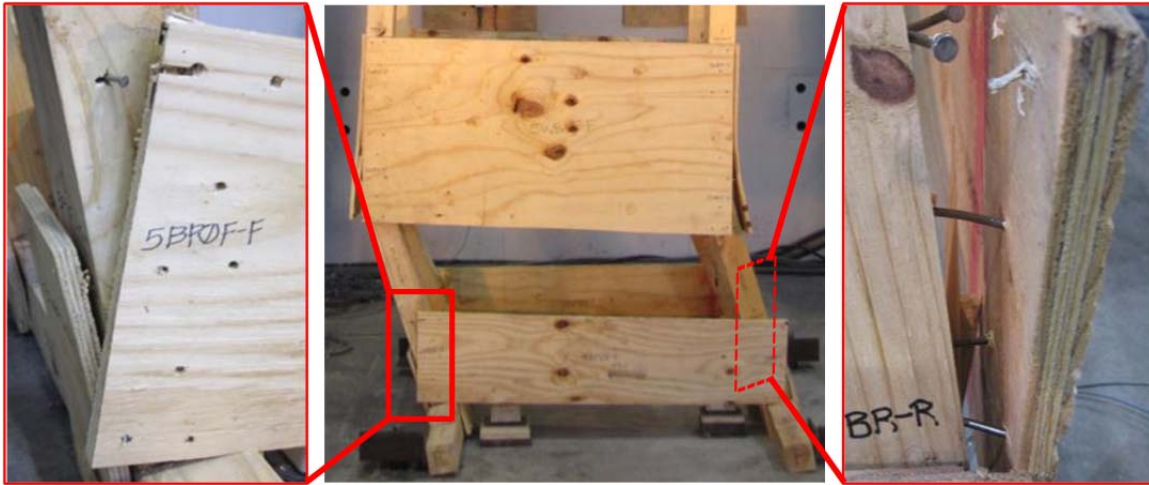
Close-up photographs of the four failures from the interior of the shore are provided in Figure 5.33.



**Figure 5.33** Post Failures A) Back-Left B) Back-Right  
C) Front-Left D) Front-Right

Failure of all four posts occurred in the region of the lower intermediate plywood brace. This caused noticeable connection failures on the lower level, and only minor failures in the upper braces. Connection failures primarily consisted of nail withdrawal from the post, or the nail pulled through the plywood brace. Samples of these connection failures are provided in Figure 5.34.





**Figure 5.34** Connection Failure Examples from Specimen 5

## 5.6 TEST SPECIMEN 6

Details regarding the test setup and the condition of the specimen prior to testing are included in Table 5-6 below.

**Table 5-6** Details for Test Specimen 6

Specimen #6	
Specimen Type	LP
Load Scenario	[C] Const Lat Displ, Incr. Vert Load
Loading Rate	0.2 in/min
Lateral Braces Used	YES
Avg. Initial Out-of-Plumb (Alignment of Top rel. to Bottom)	
L-R	1.0in L
F-B	0.6in F

Loading scenario C involved an absolute initial displacement of 6in prior to loading. With an initial out-of-plumb of 1in to the left, specimen 6 was laterally displaced an additional 5in. to reach a total lateral out-of-plumb of 6in. During vertical loading, audible cracking and creaking sounds were relatively minor, initiating at approximately 55kips. The maximum vertical load achieved was 64.6kips, after which

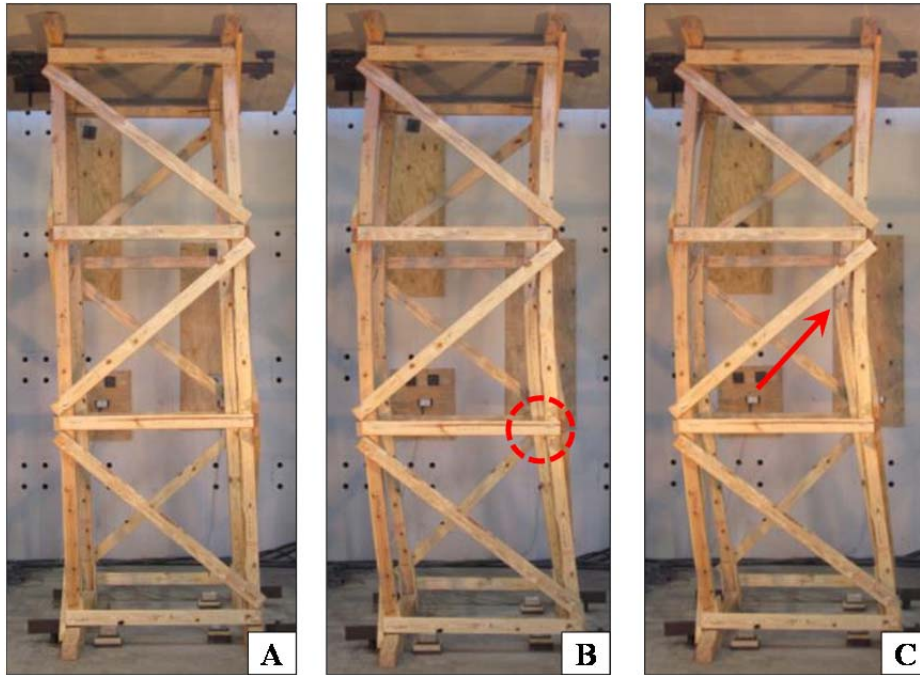
sounds of the wood fibers becoming more inelastic was prevalent.

Wedge cupping was relatively absent throughout the entire loading sequence. Splitting of the wedges was also not observed, as was common in other tests. Figure 5.35 shows the condition of the wedges at the conclusion of the test.



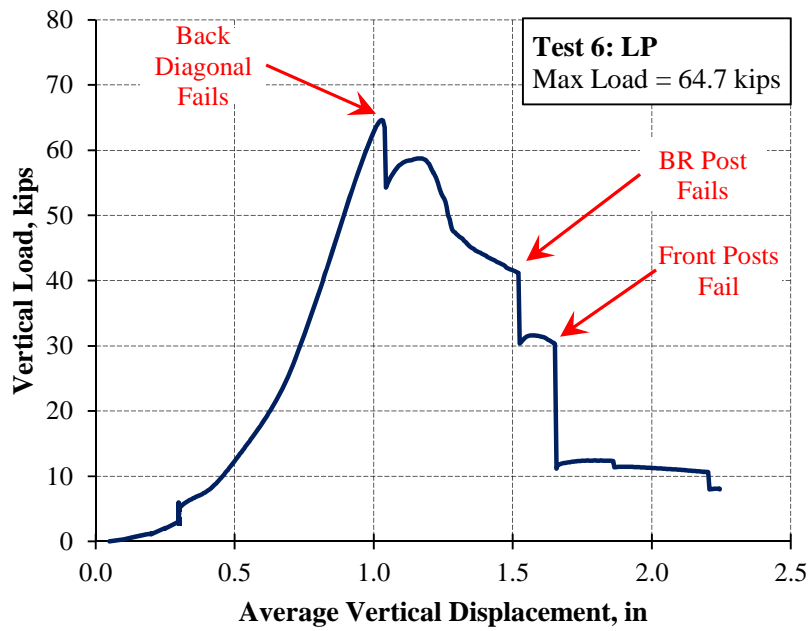
**Figure 5.35** Condition of Wedges after Loading

The first failure was a connection failure of the 1<sup>st</sup> level diagonal on the back side at the back right post. As the maximum load was attained, the top end of the diagonal withdrew from the back right post allowing substantial bending deformation of the post to occur. This connection failure and buckling behavior is depicted in Figure 5.37 as the instantaneous loss of capacity followed by a short re-stiffening of the shore between 55 and 65kips. The first buckling failure of a post occurred in the back-right post at approximately 41kips. Both front posts failed simultaneously at approximately 30kips. A pictorial representation of the different phases of testing and initial failures is presented in Figure 5.36 below.

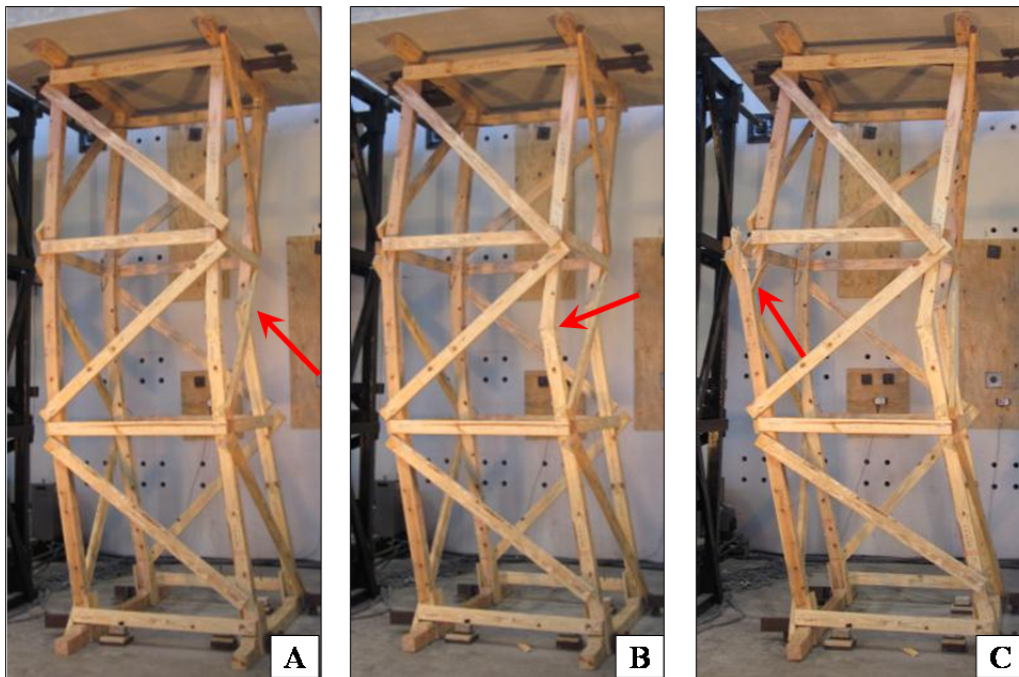


**Figure 5.36** Loading Specimen 6 A) Initial 6in Displacement Prior to Loading B) 1<sup>st</sup> Connection Failure C) Back Right Post Failure

The load-displacement plot for the entire loading scenario is presented in Figure 5.37, while photographs of the failure sequence of each post is presented in Figure 5.38 and Figure 5.39.

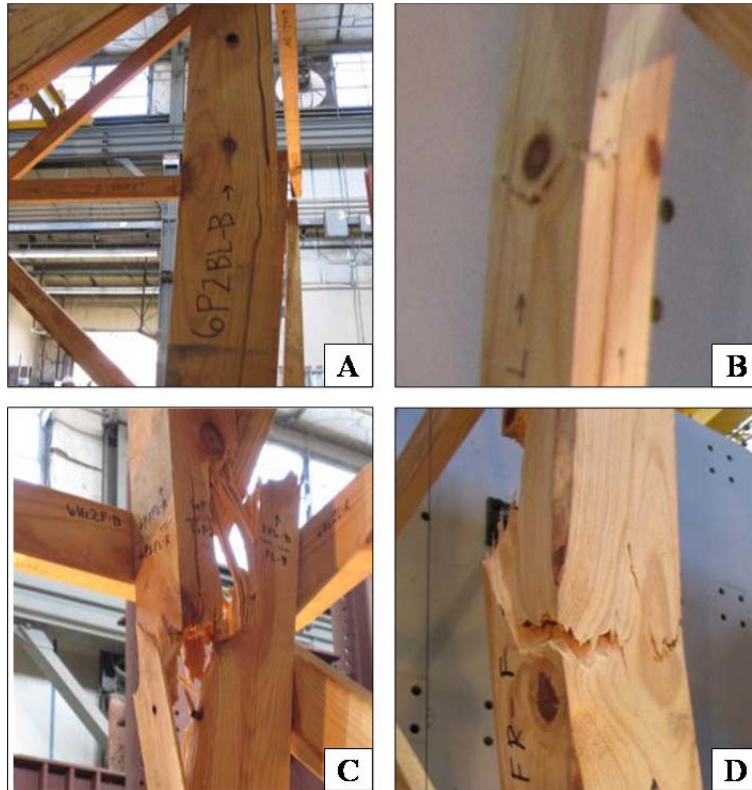


**Figure 5.37** Load-Displacement Curve for Specimen 6



**Figure 5.38** Specimen 6 Failure Sequence A) 1<sup>st</sup> Failure B) Front Right Failure  
C) Front Left Failure

The back left post split longitudinally up the post, but was not recognized until the post-loading autopsy. This split can be seen in Figure 5.39-A.



**Figure 5.39** Detailed Photographs of each Post Failure A) Back Left B) Back Right C) Front Left D) Front Right

Three 2x4 braces failed via nail withdrawal from the post. These braces locations are shown in Figure 5.40. Numerous other braces experienced partial withdrawal failures, in particular, around the regions of post failure.





**Figure 5.40** Brace Failure Locations

### 5.7 TEST SPECIMEN 7

Details regarding the test setup and the condition of the specimen prior to testing are included in Table 5-7 below.

**Table 5-7** Details for Test Specimen 7

<b>Specimen #7</b>	
Specimen Type	PLP 5ft CS
Load Scenario	[C] Const Lat Displ, Incr. Vert Load
Loading Rate	0.2 in/min
Lateral Braces Used	YES
Avg. Initial Out-of-Plumb (Alignment of Top rel. to Bottom)	
L-R	1.75in L
F-B	FL: 2.25in B FR: 0.5in F (Twist)

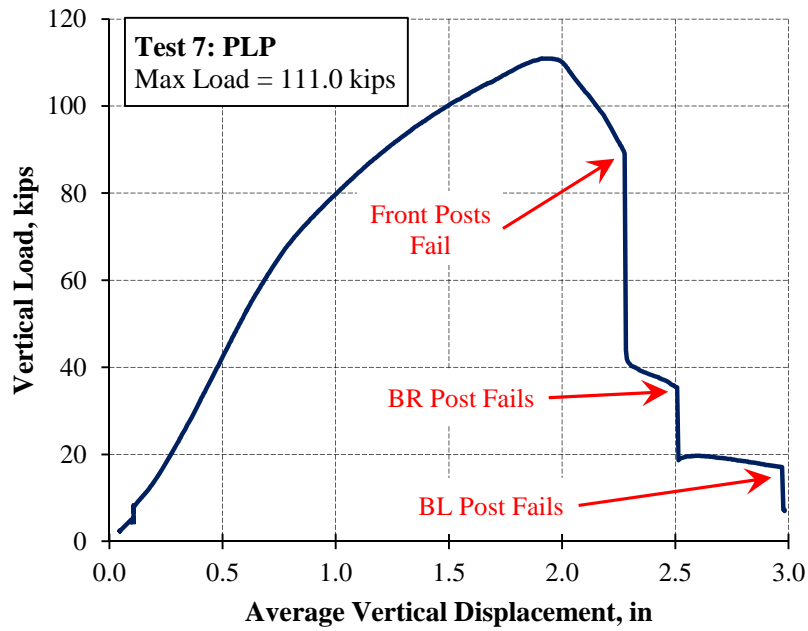
With an initial out-of-plumb of 1.75in. to the left, specimen 7 was laterally displaced an additional 4.25in. to reach a total lateral out-of-plumb of 6in. prior to vertical loading. The specimen was also twisted in the front-to-back plane. The front right post was 0.5in. towards the front while the front left post was 2.25in. towards the back. During initial vertical loading, audible cracking and creaking sounds were relatively minor, initiating at approximately 45kips. After approximately 60kips these audible sounds became more prevalent and intense.

Wedge cupping was noticeable under all four posts, initiating at approximately 80kips. Splitting of the wedges was also observed, in particular, at the location of the toe-nail. Significant bearing of the post into the wedges was observed in the post-test autopsy, as seen in Figure 5.41.



**Figure 5.41** Wedge Cupping and Bearing Under Posts During Loading

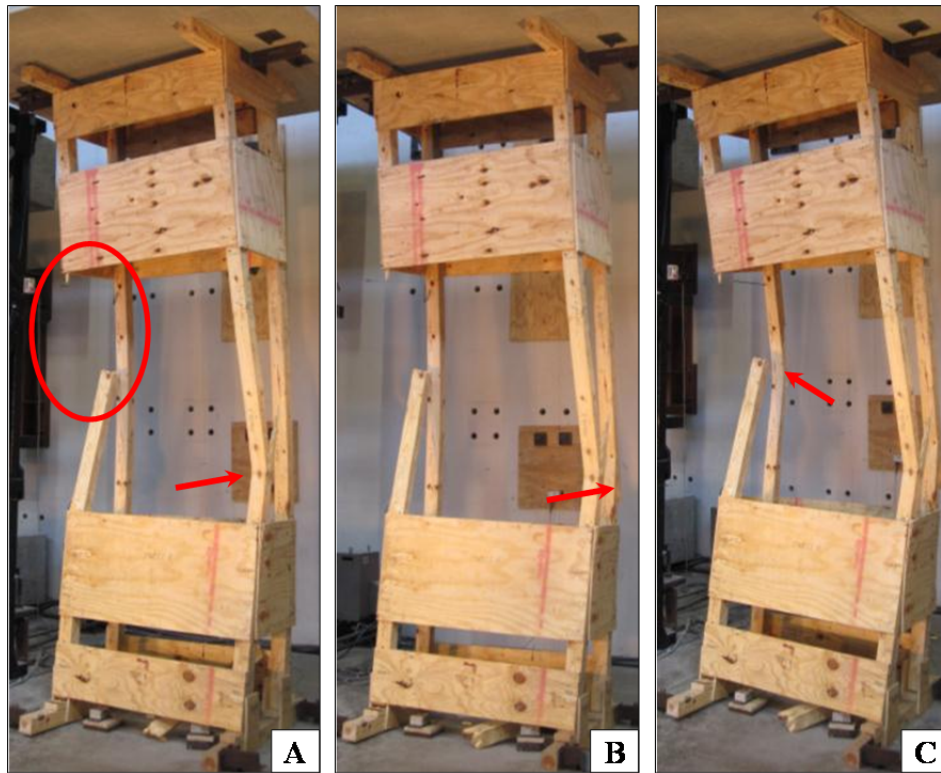
Once the peak load of 111kips was attained, the load resistance of the shore began to reduce consistently until about 88kips where an approximately 2ft section of the front left post fractured and ejected from the structure. The front right post also failed concurrently with the front left post, splitting along the back side. The back right post later failed at approximately 36kips just above the 2<sup>nd</sup> level plywood brace. The remaining post (back left) failed at around 17kips by splintering longitudinally along the back side (tension-face). The load-displacement plot for the test is shown in Figure 5.42.



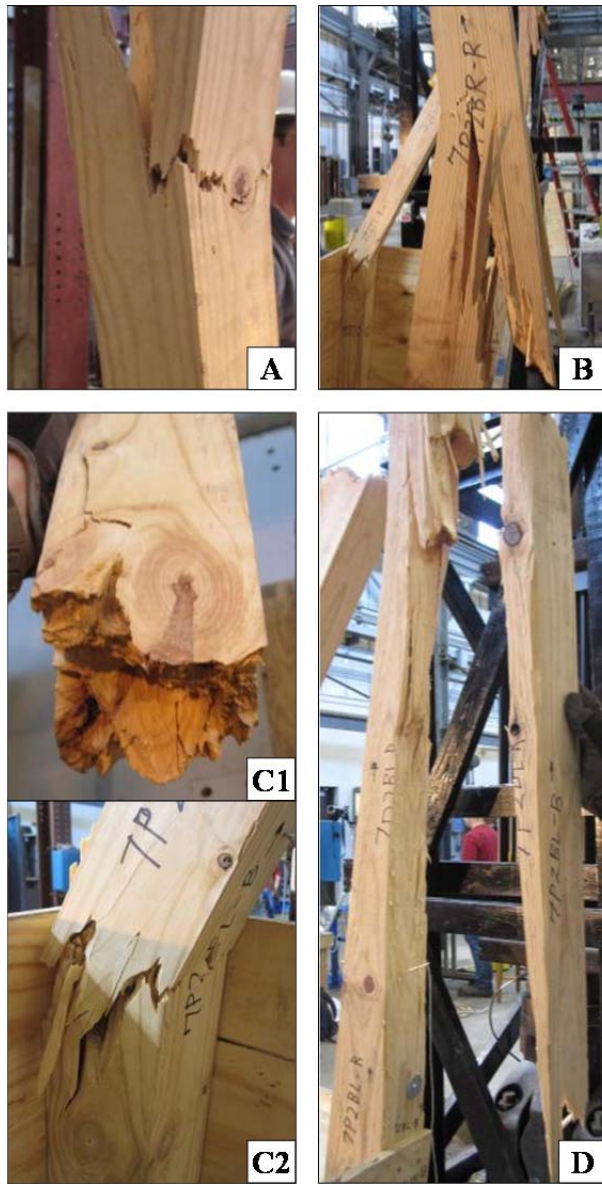
**Figure 5.42** Load-Displacement Curve for Specimen 7

The following figures display the incremental failure events of the specimen as well as close-up detailed photographs of each failure at each post.





**Figure 5.43** Failure Modes A) Initial Failures B) 3<sup>rd</sup> Failure C) 4<sup>th</sup> Failure



**Figure 5.44** Failure Photographs A) Front-Right Post B) Back-Right Post C1) Top Failure of Front-Left Post C2) Bottom Failure of Front-Left Post D) Back-Left Post

Global brace failures were not significant during testing of specimen 7. In particular, only the areas immediately adjacent to the post failures experienced nail withdrawal or tear-out. Figure 5.45 highlights these failure areas.



**Figure 5.45** Regions of Significant Brace Connection Failures

As seen above, nail withdrawal from the failure of the front-left post is clearly visible on the section of post that was expelled from the specimen during loading. Direct nail withdrawal was also found on the front-right post just below the failure. The plywood braces on the right side experienced significantly more connection failures than anywhere else on the specimen.

## **5.8 TEST SPECIMEN 8**

Details regarding the test setup and the condition of the specimen prior to testing are included in Table 5-8 below.

**Table 5-8** Details for Test Specimen 8

Specimen #8	
Specimen Type	LP
Load Scenario	[D] Const Vert Load, Incr. Lat Displ
Loading Rate	0.6 in/min
Lateral Braces Used	YES
Avg. Initial Out-of-Plumb (Alignment of Top rel. to Bottom)	
L-R	0.3in R
F-B	0.3in F

Specimen 8 was loaded to the design capacity (32kips), then laterally displaced to the right while the 32kip load was maintained. The tower was relatively plumb with only a minor initial deformation in the direction of the lateral motion for the test.

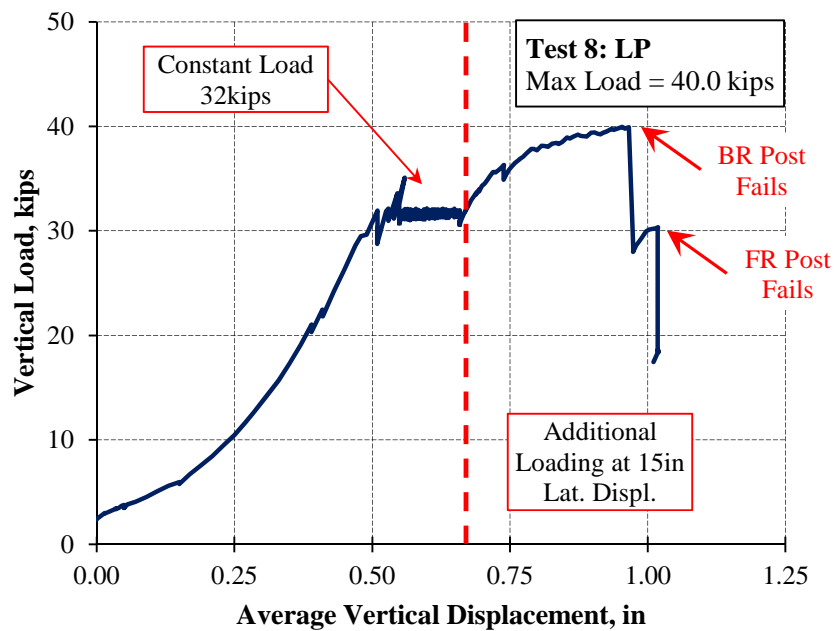
In the course of initial loading, minor to moderate cracking sounds were heard on occasion. During the lateral movement phase of the test, very few creaking sounds were heard, all of which were very moderate in intensity. The first considerable cracking sounds were heard at approximately 13.5in. of lateral displacement.

Throughout both the lateral displacement phase and vertical loading phase, no cupping of any of the four pairs of wedges was witnessed. Shown in Figure 5.46 is the status of the wedges at 15in. displacement under vertical load.

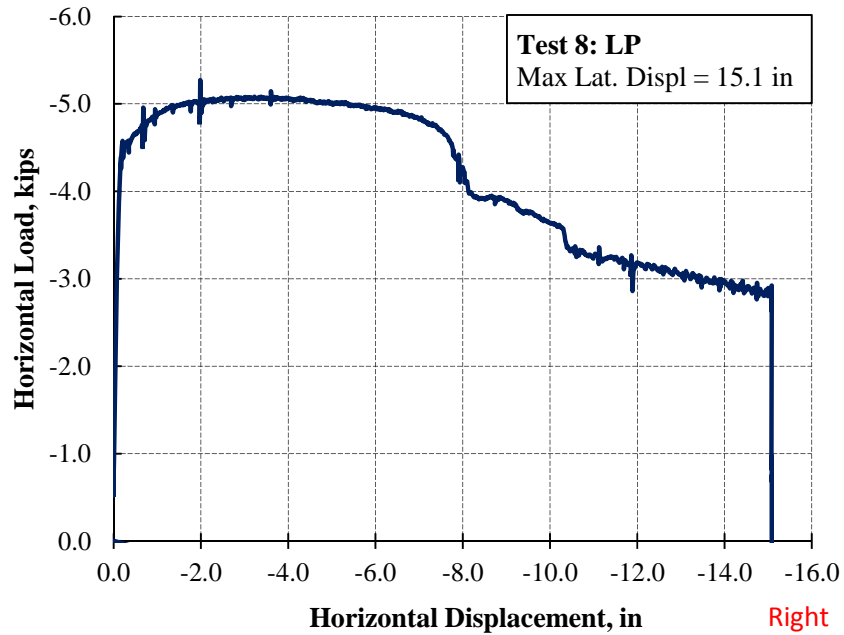


**Figure 5.46** Photograph of Wedges at 15in. Displacement

Under the initial 32kip load, specimen 8 was successfully displaced a total of 15in (top relative to bottom) to the right. Upon reaching the 15in. lateral displacement limit of the test frame, lateral displacement was held constant while the vertical load was increased until failure. Shown in Figure 5.47 and Figure 5.48 are the vertical load-displacement curve and lateral load-displacement curve for specimen 8. The vertical load-displacement curve depicts both phases of the test, constant load during lateral movement and increasing load during constant 15in. displacement.



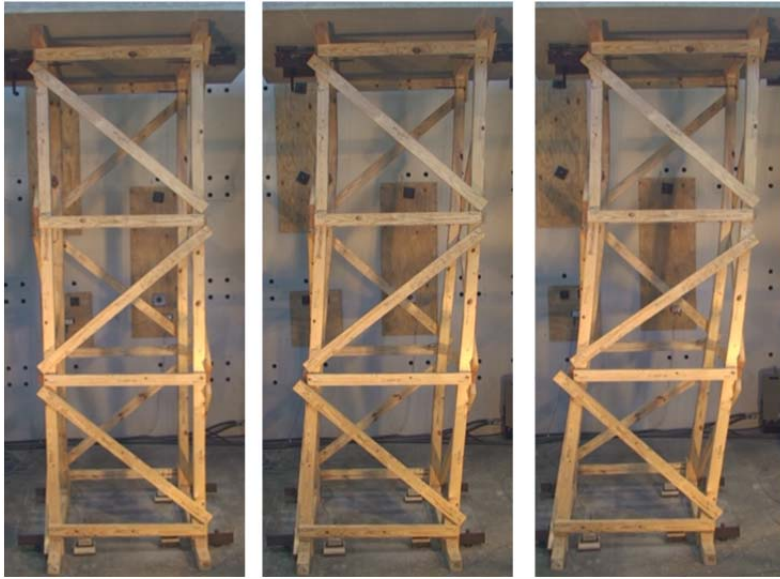
**Figure 5.47** Vertical Load-Displacement Curve for Specimen 8



**Figure 5.48** Horizontal Load-Displacement Curve for Specimen 8

During the lateral displacement phase, a maximum force of 5.3kips was required in the process of displacing the shore a total of 15in. to the right, after which the displacement was held constant while the shore was vertically loaded to failure at 40.0kips. At 40.0kips the back right post failed, followed by the front right post at approximately 30kips. Both failures were similar in failure type (at a knot) and direction, failing with the tension face to the right in the direction of eccentricity. Figure 5.49 shows the progression of the lateral displacement phase while Figure 5.50 shows the individual failures.



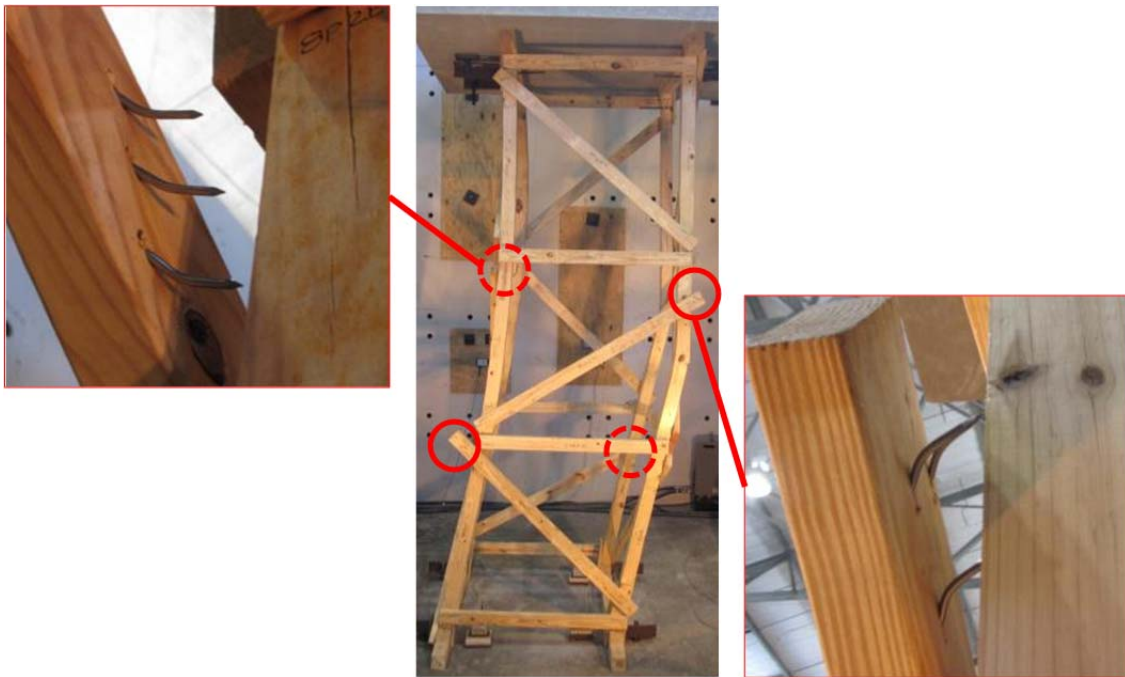


**Figure 5.49** Progression of Lateral Displacement with Applied 32kip Load



**Figure 5.50** Photographs of Right Side Post Failures

Multiple diagonal braces failed at their connections throughout the lateral and vertical loading phases of the test. The first level diagonal braces on both the front and back face slowly failed at their upper connections during the lateral displacement phase, becoming completely detached by 10.5in. of displacement. The second level diagonal brace on the front began to fail at its top-most connection between 11in. and 13in. A diagram of each brace failure is included below along with detailed photographs of some of the connection failures.



**Figure 5.51** Connection Failures of Braces

The horizontal braces did not disconnect from the posts, however considerable rotation at the joint can be seen. Figure 5.52 shows a close up of the first level horizontal brace connection at the front right post. The angle between these members is no longer 90 degrees, but the brace connection did not pullout.





**Figure 5.52** Photograph of 1<sup>st</sup> Level Front Right Joint

## 5.9 TEST SPECIMEN 9

Details regarding the test setup and the condition of the specimen prior to testing are included in Table 5-9 below.

**Table 5-9** Details for Test Specimen 9

Specimen #9	
Specimen Type	PLP 5ft CS
Load Scenario	[D] Const Vert Load, Incr. Lat Displ
Loading Rate	0.6 in/min
Lateral Braces Used	YES
Avg. Initial Out-of-Plumb (Alignment of Top rel. to Bottom)	
L-R	2.5in L
F-B	FL: 2.25in B FR: 1.25in F (Twist)

Specimen 9 was loaded to the design capacity (32kips), and then laterally displaced to the right while the 32kip load was maintained. The tower had a clockwise twist of the top relative to the bottom, as well as a considerable out-of-plumb to the left. Lateral displacement was conducted to the right; therefore the initial lateral deflection also impacted the maximum lateral displacement achieved. With a lateral displacement limit of 15in. to the right, the maximum lateral displacement that the tower could displace was 12.5in.

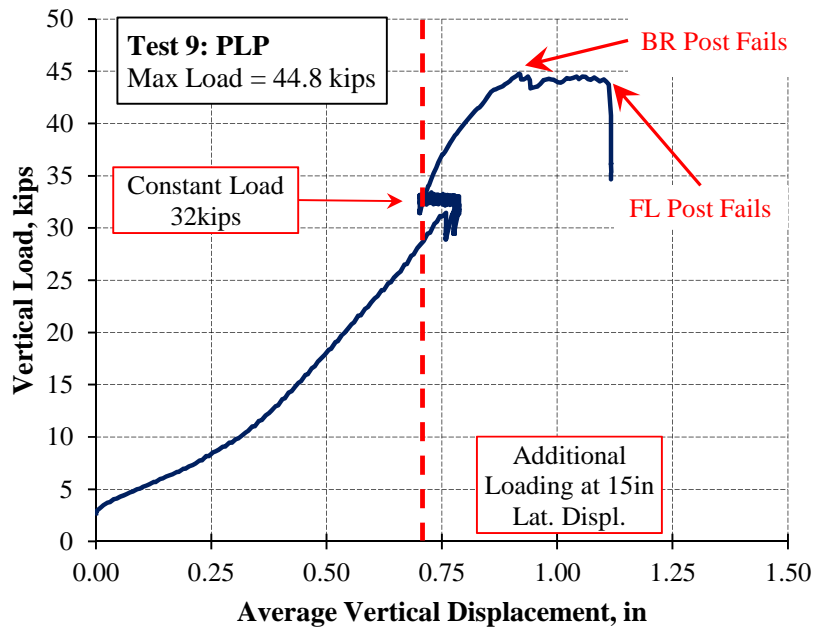
During initial loading, a few moderate cracking/creaking noises were heard just before 32kips was attained. During the lateral displacement phase, moderate creaking sounds were heard starting at 7in. of displacement, and varied in frequency and intensity up through 15in.

Cupping was not observed during either phase of loading. The back right wedge had a slight gap between the two wedges in the set, but was not significant enough to be considered a fuse.

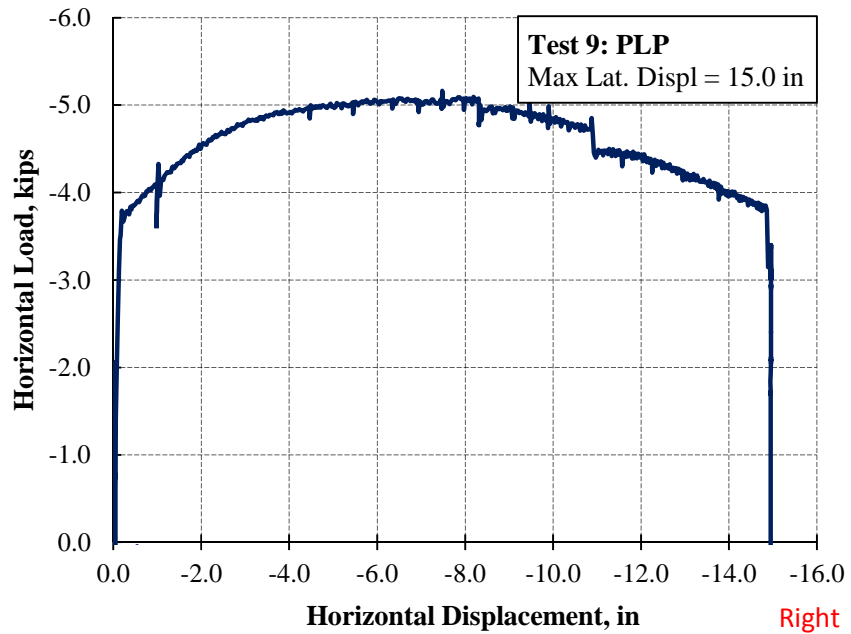


**Figure 5.53** Photographs of Wedges A) Left Side B) Right Side

At approximately 14.9in of lateral displacement, the back left post split around a knot near the second level of bracing. The vertical load of 32kips was maintained after the split, and the full 15in. of displacement was attained. Therefore the displacement was held constant and vertical load was increased until complete failure of the shore was achieved. Shown in Figure 5.54 and Figure 5.55 are the vertical load-displacement curve and lateral load-displacement curve for specimen 9. The vertical load-displacement curve depicts both phases of the test, constant load during lateral movement and increasing load during constant 15in. displacement.



**Figure 5.54** Vertical Load-Displacement Curve for Specimen 9



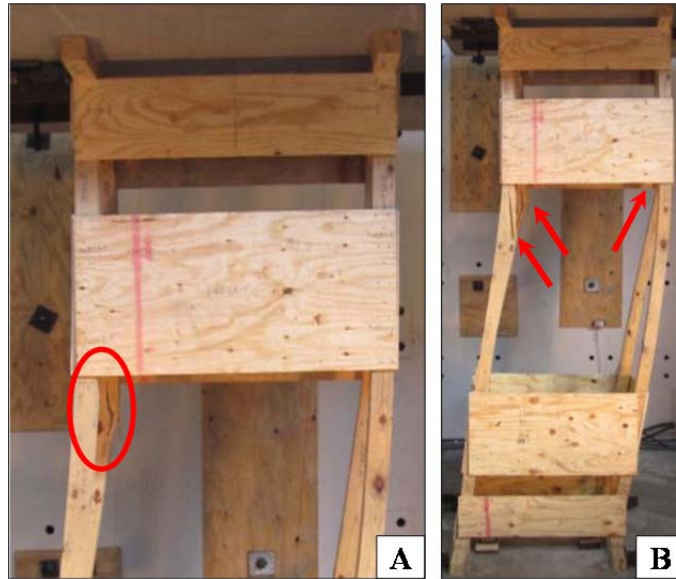
**Figure 5.55** Horizontal Load-Displacement Curve for Specimen 9

A maximum lateral load of 5.2kips was required to displace the shore laterally to a total of 15in., 12.5in. from plumb due to the initial deformation. For an unknown reason, Figure 5.54 shows a decrease in shore's vertical displacement during the lateral displacement phase, possibly due to tilting of the shore. Figure 5.56 shows the progression of the lateral displacement phase.



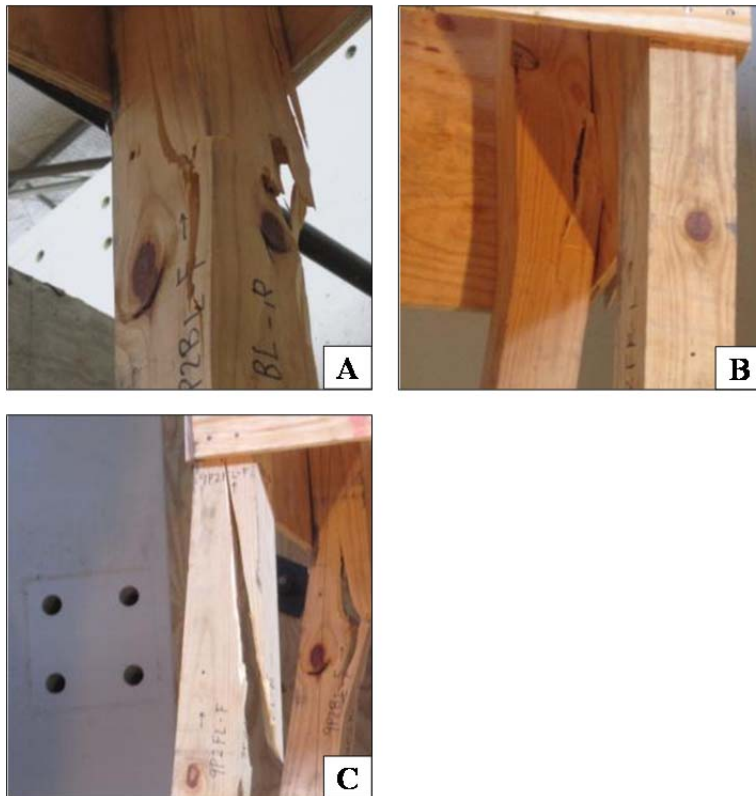
**Figure 5.56** Progression of Lateral Displacement with Applied 32kip Load

Once the 15in. lateral limit was reached the shore was vertically loaded while the 15in. lateral displacement was held constant. Just prior to reaching 45kips, the back right post began to split and fail within the second level brace region. As the loading was maintained, the splits in both the back right and back left posts increased in magnitude until the front left post failed, concluding the test. Figure 5.57 shows the initial failure at 14.9in. lateral deflection, and the final condition of the shore.



**Figure 5.57** Post Failure Locations A) Initial Failure During Lateral Displacement B) Final Shore Condition

The three individual post failures are presented in Figure 5.58. Each failure was unique, but all were tension face failures in the direction of the lateral displacement.



**Figure 5.58** Individual Post Failures A) Back Left Post  
 B) Back Right Post C) Front Left Post

The plywood braces and their respective connections performed well. Only minor nail withdrawal was observed on the front and back braces (see Figure 5.59).



**Figure 5.59** Photographs of Brace Connection Failures

## 5.10 TEST SPECIMEN 10

Details regarding the test setup and the condition of the specimen prior to testing are included in Table 5-10 below.

**Table 5-10** Details for Test Specimen 10

<b>Specimen #10</b>	
Specimen Type	LP* (No.2 SYP)
Load Scenario	[B] Cyclic Loading
Loading Rate	3.5in/min
Lateral Braces Used	YES
Avg. Initial Out-of-Plumb (Alignment of Top rel. to Bottom)	
L-R	1.0in L
F-B	FL: 2.25in F FR: 1.75in B (Twist)

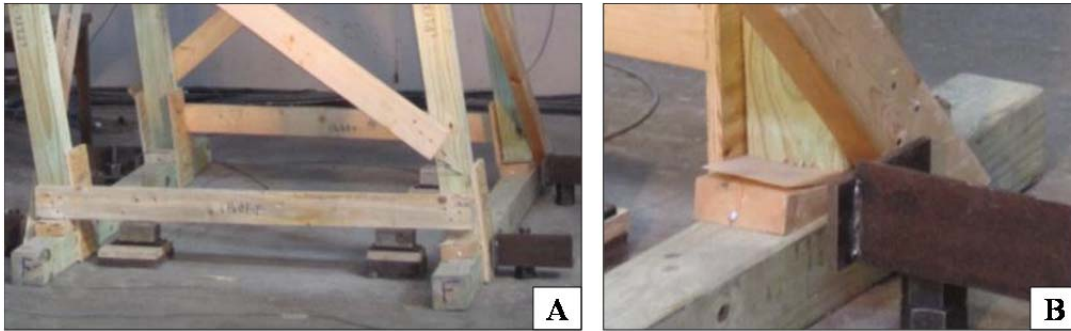
Specimen 10 was initially built as a prototype to use in preliminary and experimental loading sequences prior to testing the first shore. None of the testing sequences applied loads greater than the 32kip design capacity. It is for this reason that shore 10 was built using Southern Yellow Pine No. 2 lumber rather than the specified No.1 grade.

Shore 10 had a counterclockwise twist of the top relative to the base, as well as a 1.0in. deflection to the left. The cyclic lateral motion was in the left-to-right direction. Therefore the average 1.0in. out-of-plumb in the left direction impacts the relative lateral displacement of the shore. At the cyclic amplitude of 2in. to the left, the shore headers are actually 3.0in. offset from the footers. At 2in. to the right, the shore headers are actually 1.0in. offset from the footers. The effects of this initial offset are magnified during the 4in. lateral cycles.

Audible creaking sounds were very minor during cyclic loading. In particular, the first cycle of each phase induced the majority of the creaking sounds that were heard for the duration of the phase. These audible sounds increased in frequency and magnitude during the 4in. cycles, but were still very minor.

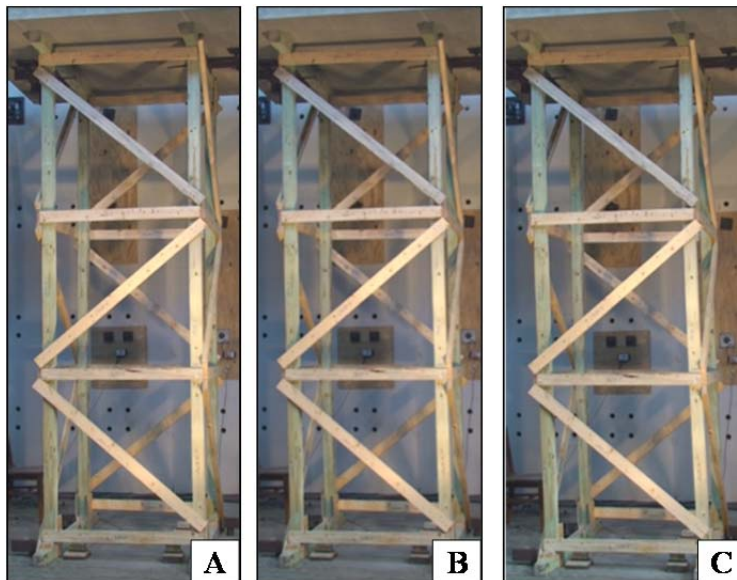


The back right wedges were the only wedges that cupped during testing. These wedges began cupping during the initial 32kip loading sequence, and slightly increased up until failure. Photographs of the wedges are provided below.



**Figure 5.60** Wedge Performance A) Shore Base at Failure B) Back Right Wedge

Shore 10 successfully completed three 2in. cycles and three 4in cycles under a sustained vertical load of 32kips as well as three 2in. cycles under a sustained load of 48kips. These cycles can be seen in Figure 5.61 and the vertical and lateral load-deflection curves are shown in Figures 5.62 and 5.63.



**Figure 5.61** Loading Sequence A) Initial State B) 2in. Cycles C) 4in.



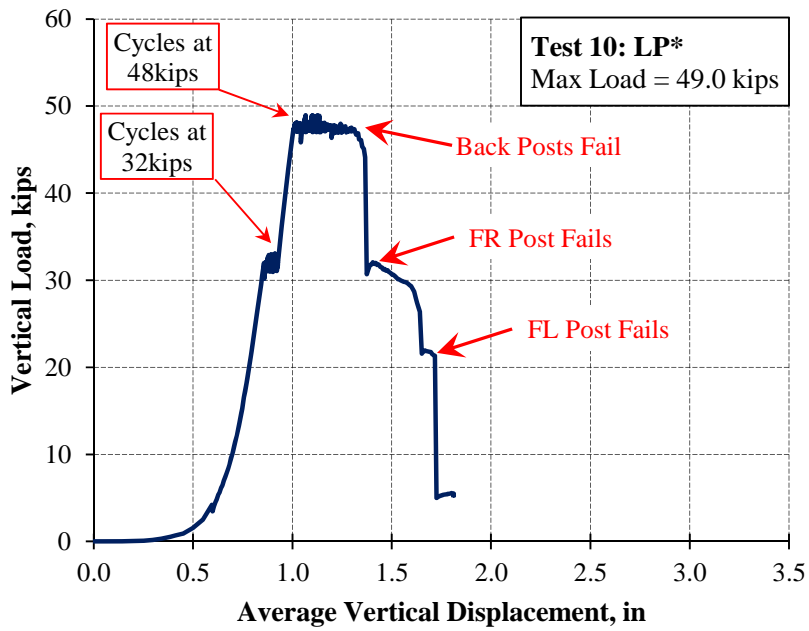


Figure 5.62 Load-Displacement Curve for Specimen 10

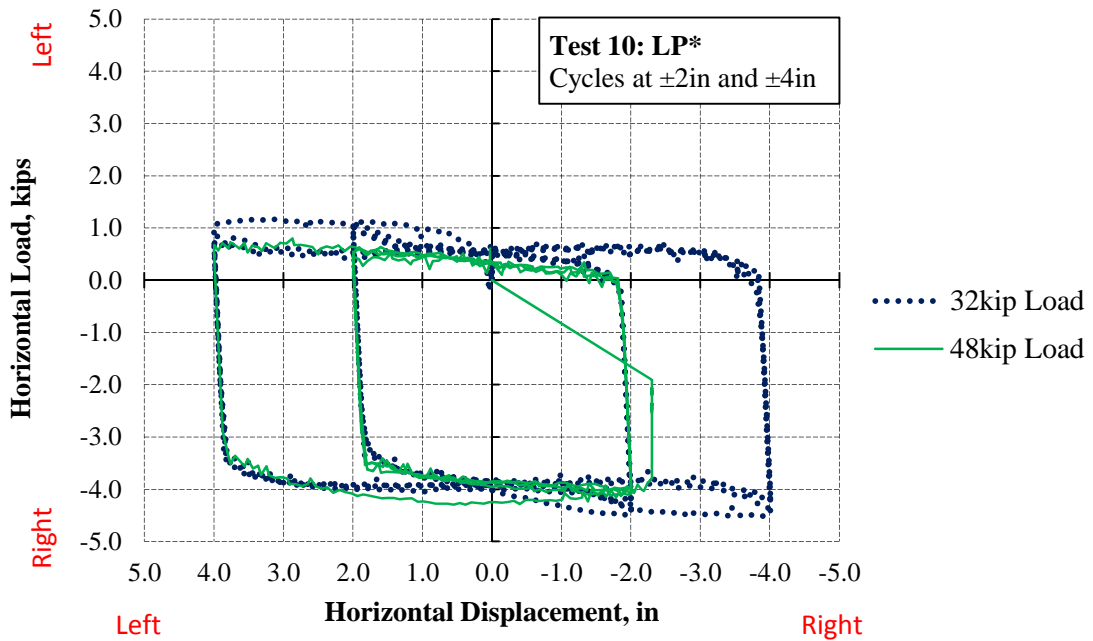
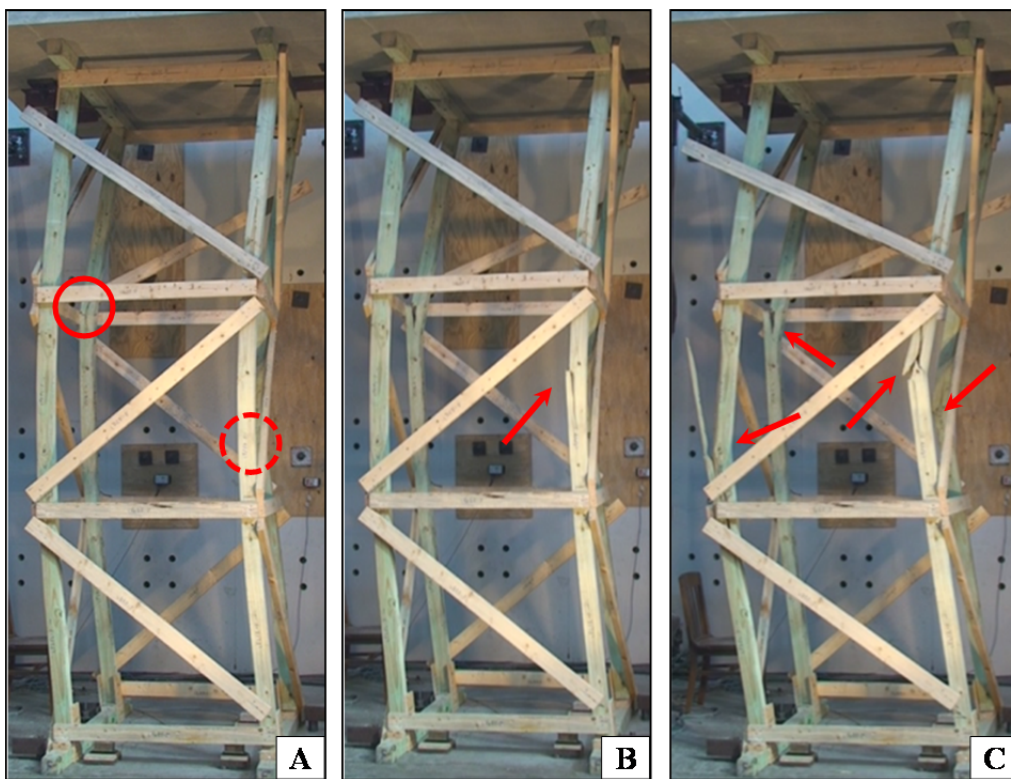
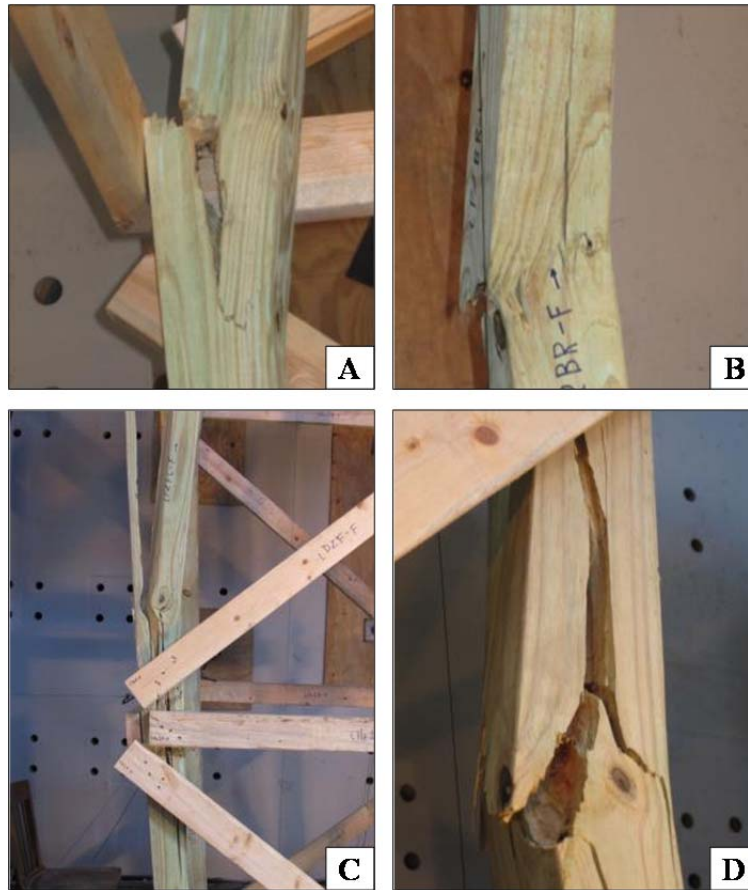


Figure 5.63 Comparison of Horizontal Load-Displacement Cycles for each Vertical Load

Failure of the shore occurred during the first, 4in. cycle under 48kips of vertical load. As the shore was displaced 2.3in. to the right, the back left post failed at the second level joint and the back right post failed just above the first level joint. The next failure occurred in the second bay of the front right post at approximately 32kips, which was accompanied by the widening of the first set of failures. This was closely followed by the failure of the front left post at approximately 22kips, at which point the test was stopped. These failures are presented below.

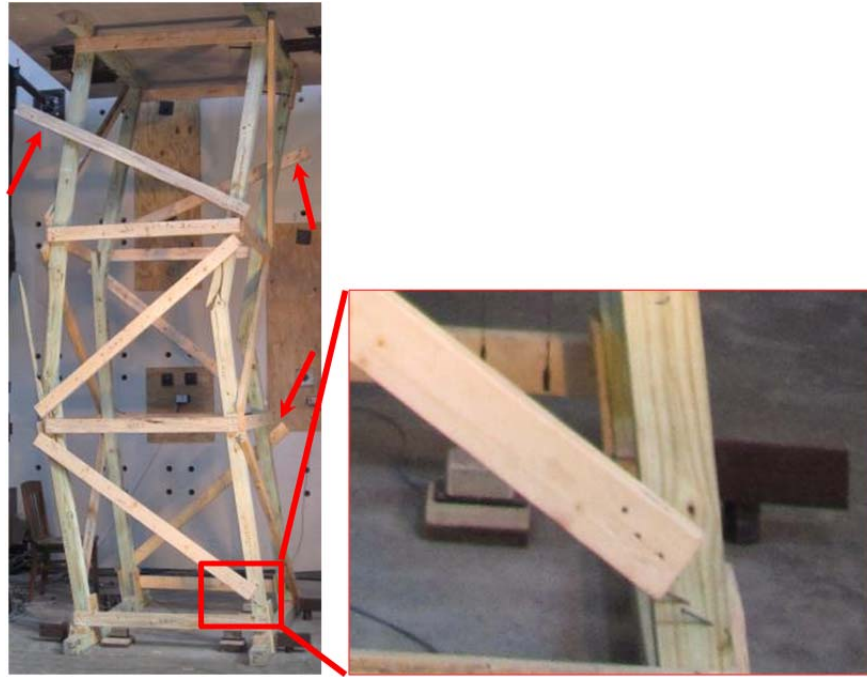


**Figure 5.64** Post Failures A) Initial Failures B) Secondary Failure C) Final State



**Figure 5.65** Failure Close-ups A) Back Left Post B) Back Right Post C) Front Left Post D) Front Right Post

All of the braces remained attached to the posts until the first failure occurred. At first failure, the third level diagonal on the back side failed at the top connection. The third level diagonal on the front disconnected from the left post shortly after the back diagonal in a manner that suggests the connection primarily failed during the first post failure. The first level diagonal on the front face progressively pulled the nails through the 2x4 during the multiple failure sequences (see Figure 5.66). The 1<sup>st</sup> level diagonal on the back face failed at the top connection after the second set of post failures, and was the last complete failure of a brace connection. These failures are shown in Figure 5.66.



**Figure 5.66** Diagonal Brace Connection Failures

### 5.11 TEST SPECIMEN 11

Details regarding the test setup and the condition of the specimen prior to testing are included in Table 5-11 below.

**Table 5-11** Details for Test Specimen 11

<b>Specimen #11</b>	
Specimen Type	LP
Load Scenario	[B] Cyclic Loading
Loading Rate	3.5in/min
Lateral Braces Used	YES
Avg. Initial Out-of-Plumb (Alignment of Top rel. to Bottom)	
L-R	1.1in R
F-B	1.3in F

Specimen 11 was constructed to provide additional cyclic data for a LP shore built to specifications to supplement the data from Specimen 10 which was not built

using No.1 grade material. Specimen 11 had an initial out-of-plumb of 1.1in to the right, which impacted the actual displacement of the shore during the lateral displacement cycles. At the cyclic amplitude of 2in. to the left, the shore headers are actually 0.9in. offset from the footers. At 2in. to the right, the shore headers are actually 3.1in. offset from the footers. The effects of this initial offset were magnified during the 4in. lateral cycles.

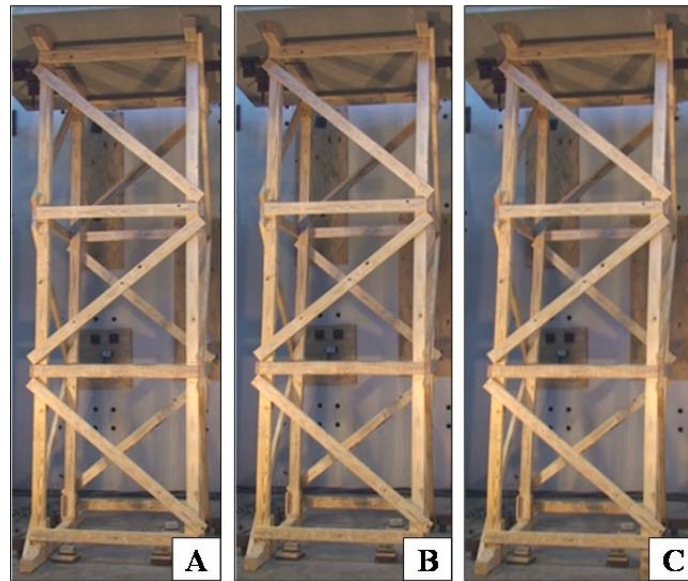
Only minor creaking sounds were heard during the lateral loading cycles. In particular, the majority of these audible sounds were heard during the first cycle of each phase of testing. However, in general, audible wood cracking/creaking sounds were very infrequent and minor in intensity up until first failure.

Wedge cupping was not observed during the loading sequence. The wedges did not appear to be impacted by the cyclic motion nor the vertical loads applied. Photographs of the wedges at failure are shown below.

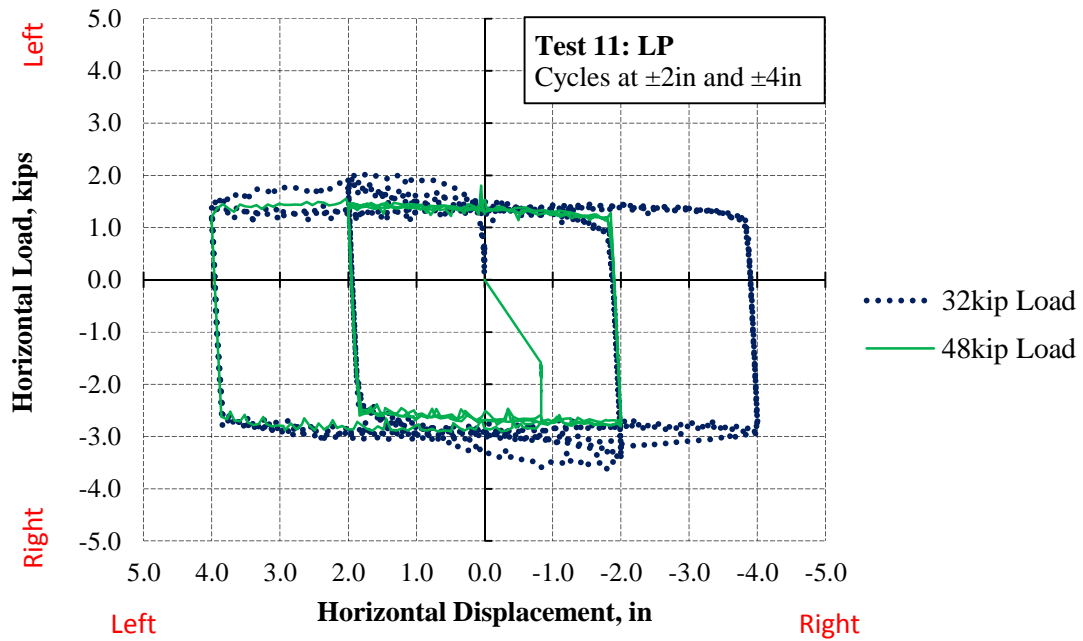


**Figure 5.67** Status of the Wedges at Failure

Specimen 11 successfully completed three, 2in. amplitude cycles and three 4in cycles under 32kips of vertical load as well as three, 2in. amplitude cycles under 48kips. The progression of these cycles can be seen in the photographs below as well as in the load-displacement plot in Figure 5.69.



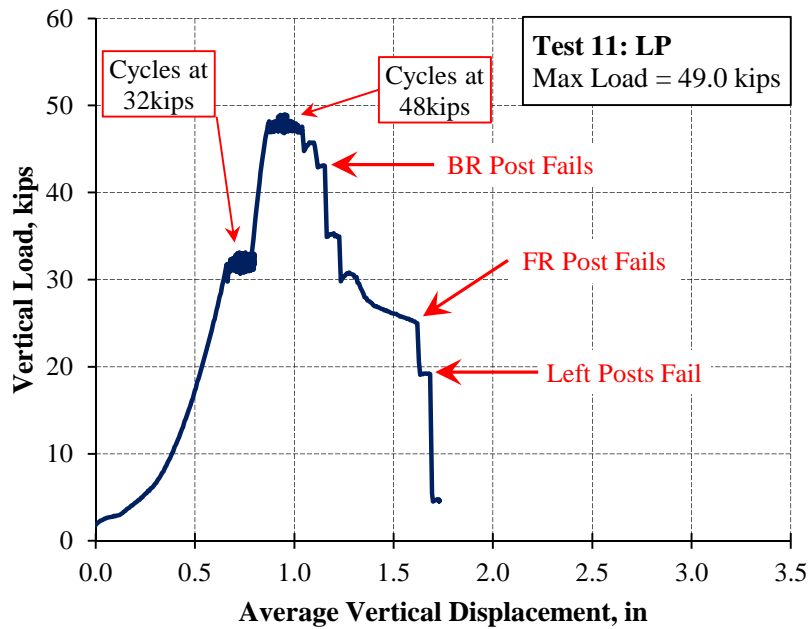
**Figure 5.68** Loading Sequence A) Initial State B) 2in Cycles C) 4in Cycles



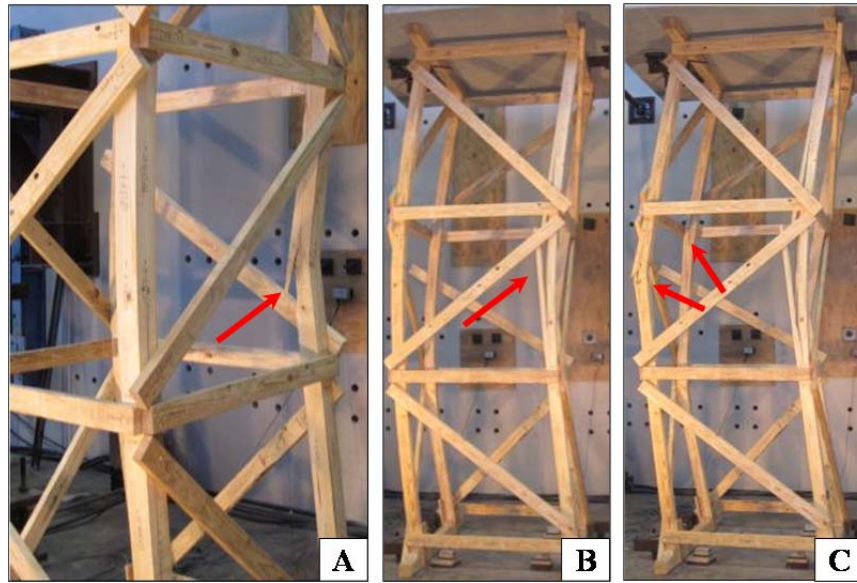
**Figure 5.69** Comparison of Horizontal Load-Displacement Cycles for each Vertical Load



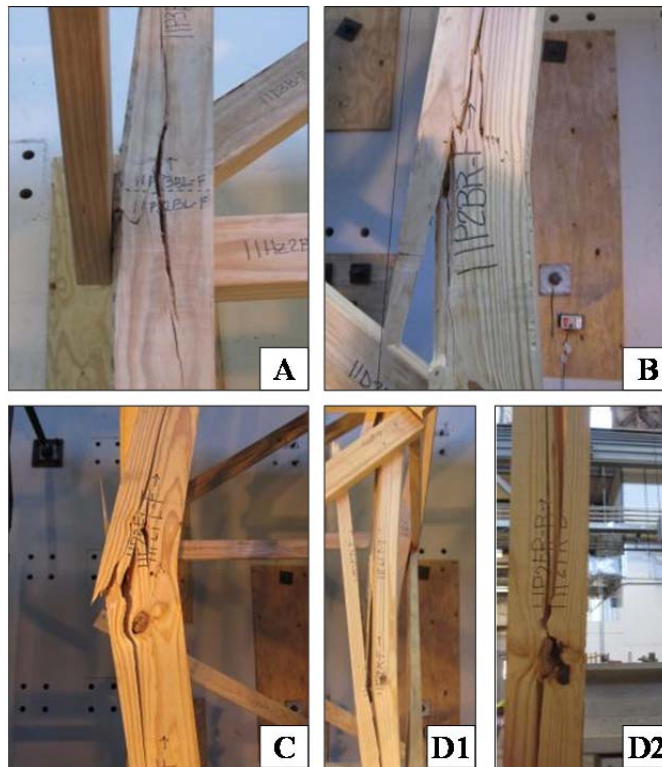
As seen in Figure 5.69, specimen 11 failed during the first 4in. cycle under 48kips of vertical load. After successfully displacing 4in. to the left, the back right post failed at approximately 0.8in. lateral displacement to the right. This initial failure was characterized by a series of loud popping noises as the post failed and the second level diagonal on the back failed at its connection. This series of initial failures in the back right post can be seen in Figure 5.70 between the vertical loads of 48 and 30kips. The second failure occurred in the front right post at approximately 25kips, followed closely by the simultaneous failures of both the front and back posts on the left side at 19kips. The progression of failures can be seen in the load-displacement curve in Figure 5.70, and also in the photographs provided.



**Figure 5.70** Load-Displacement Curve for Specimen 11



**Figure 5.71** Failure Sequence A) 1<sup>st</sup> Failure B) 2<sup>nd</sup> Failure C) Final Failures

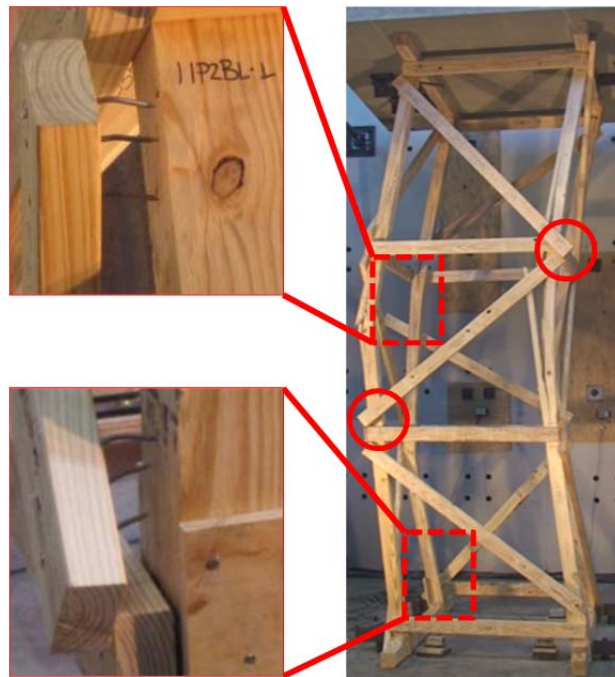


**Figure 5.72** Failures A) Back Left Post B) Back Right Post C) Front Left Post D1) Front Right (Front) D2) Front Right (Back)



Each post failure occurred with the tension face on the left, away from the eccentricity produced by the top of the shore being displaced to the right. The characteristics of all four failures were long splitting type failures running longitudinally up and down the posts.

Diagonal brace failures occurred during the testing sequence both prior to and after the initial failure of the back right post. The top connection of the second level diagonal brace on the back of the shore pulled out prior to first failure as well as the bottom connection of the first level diagonal on the back face. Partial withdrawal of the bottom connection of the second level diagonal brace on the front was also observed prior to first failure. After first failure, the bottom connection of the third level diagonal on the front of the shore failed. Photographs of these brace failures are presented below.



**Figure 5.73** Brace Connection Failures

## 5.12 TEST SPECIMEN 12

Details regarding the test setup and the condition of the specimen prior to testing are included in Table 5-12 below.

**Table 5-12** Details for Test Specimen 12

<b>Specimen #12</b>	
Specimen Type	PLP 5ft CS
Load Scenario	[E] Rapid Vertical Loading
Loading Rate	0.4in/min
Lateral Braces Used	NO
Avg. Initial Out-of-Plumb (Alignment of Top rel. to Bottom)	
L-R	0.9in L
F-B	0.8in F

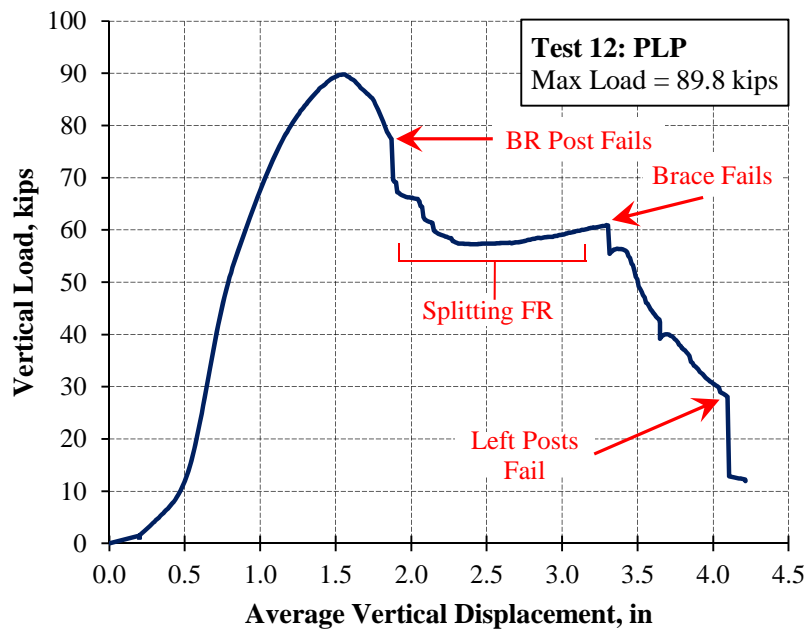
As discussed in the background study, wood members are sensitive to the rate at which loads are applied. Therefore specimen 12 was tested under vertical load only, at twice the loading rate as the comparable specimen 2. During loading, minor creaking sounds were heard beginning at 50kips. These audible cracking sounds increases in frequency and magnitude as the loading progressed, in particular after 80kips.

Wedge cupping was observed during loading. All four sets of wedges began noticeably cupping at approximately 60kips, and increased as loading continued. Each set of wedges cupped to a different magnitude, but all were clearly recognizable. Photographs of the wedges are provided below.



**Figure 5.74** Wedge Performance A) Left Side B) Right Side

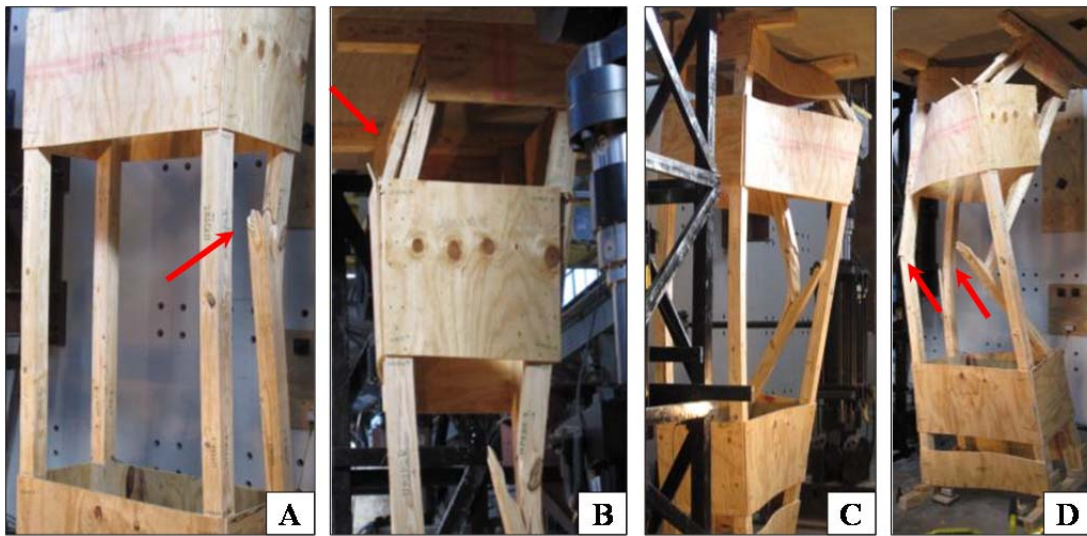
After reaching a peak load of 89.8kips, audible sounds of cracking and distress were very frequent and very loud. The right side began to buckle towards the front, and initial failure occurred in the back right post at a load of 78kips. Splitting of the front right post in the region of the second intermediate brace began at approximately 65kips. The right side was noticeably bent forward, and considerable twisting of the plywood braces on the front, back and right side was observed. Also at this point, considerable bearing of the post and top plywood brace into the left header was witnessed. As seen in Figure 5.75, the capacity slightly increased before losing capacity at 60kips, which correlated to the connection failure of the second intermediate plywood brace on the right side from back right post. Large deformations occurred as the tower tilted to the left, lifting the right footer completely off the ground. Final failure occurred at approximately 28kips as the two left posts buckled to the left. The load-displacement curve for specimen 12 is presented in Figure 5.75. Also shown below are photographs of the progressive failures.



**Figure 5.75** Load-Displacement Curve for Specimen 12



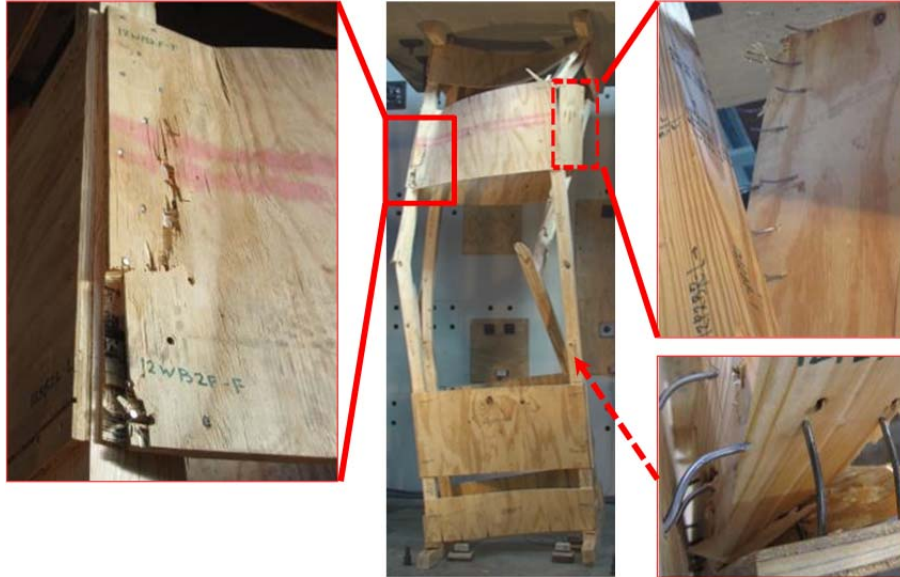
**Figure 5.77** Progressive Failure of Specimen 12



**Figure 5.76** Failures A) 1<sup>st</sup> Failure B) 2<sup>nd</sup> Failure C) Excessive Torsional Buckling of Braces, Excessive Deflection D) Final Failure of Left Posts

Overall, the plywood braces performed well under extreme torsional loads. The second level right plywood brace experienced a complete pullout failure from the back right post. The second level plywood brace on the front left side yielded around the

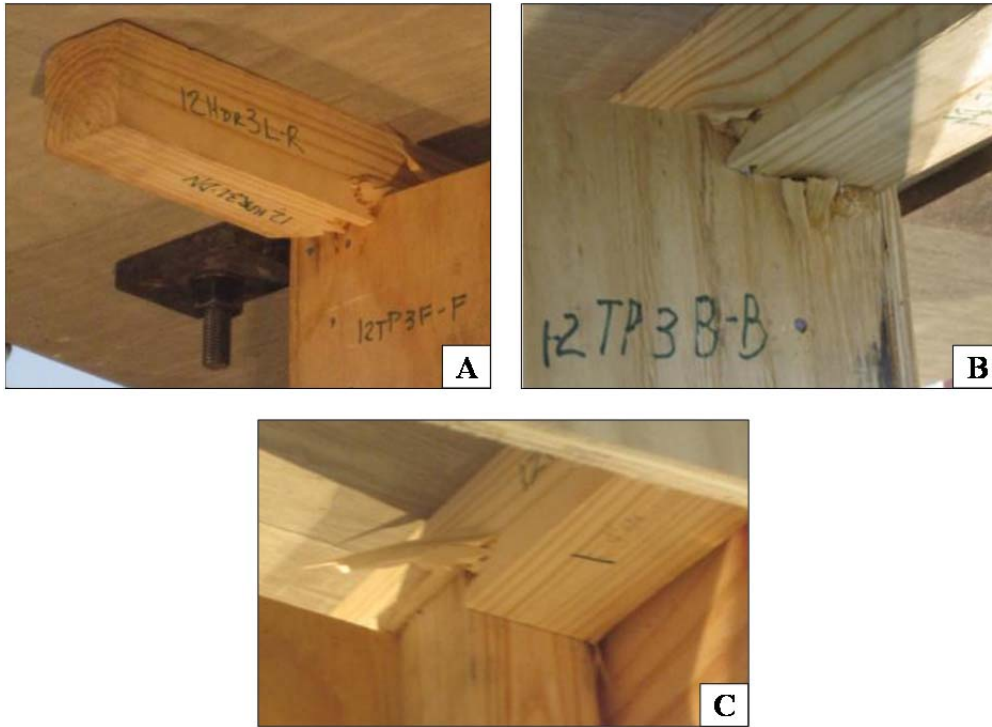
fasteners as the brace was torqued and bent out of plane. Other minor nail withdrawal from the posts were observed but were limited to a few nails. Photographs of these failures are presented below.



**Figure 5.78** Brace Connection Failures

As mentioned in the failure sequence, considerable bearing was observed of the front left post and brace into the left header during testing. The post-test autopsy revealed considerable bearing of the back left post into the left header as well. These two cases of extreme bearing are presented below.





**Figure 5.79** Bearing Into Left Header A) Front Left B) Back Left C) Front Left  
(Interior)

### 5.13 TEST SPECIMEN 13

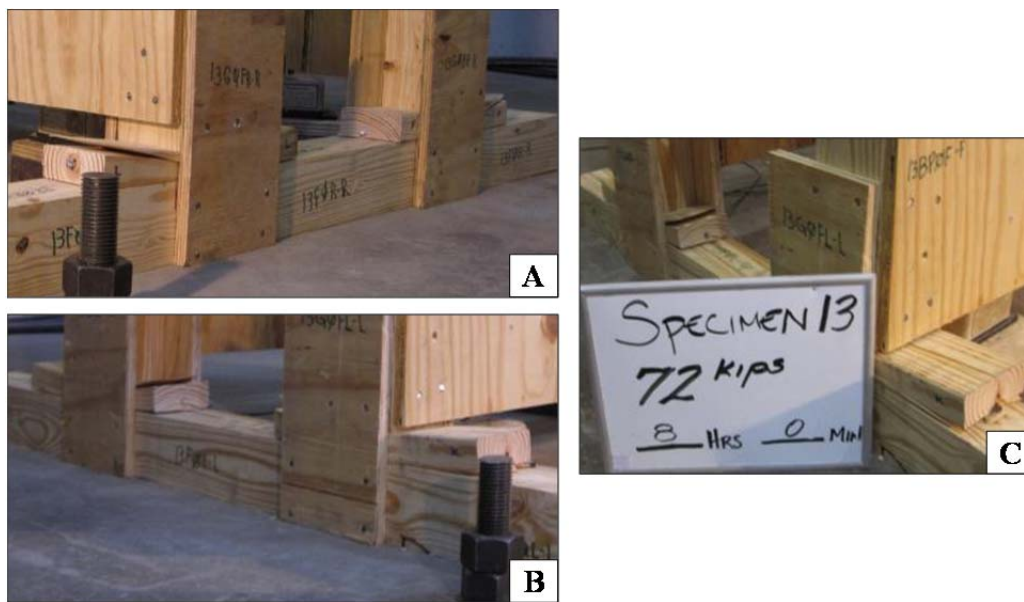
Details regarding the test setup and the condition of the specimen prior to testing are included in Table 5-13 below.

**Table 5-13** Details for Test Specimen 13

<b>Specimen #13</b>	
Specimen Type	PLP 5ft CS
Load Scenario	[F] Sustained Vertical Loading
Loading Rate	72kips for 8hrs
Lateral Braces Used	NO
Avg. Initial Out-of-Plumb (Alignment of Top rel. to Bottom)	
L-R	1.0in L
F-B	0.3in F

As the counterpart to specimen 12, specimen 13 was tested under a constant load for 8 hours, to investigate the effects of a sustained load on the towers. The determined load for specimen 13 was 85 percent of the maximum capacity of specimen 12 which equates to 72kips. This load was maintained without the addition of lateral deflection for 8 hours, therefore the initial out-of-plumb of 1.0 inch was not corrected.

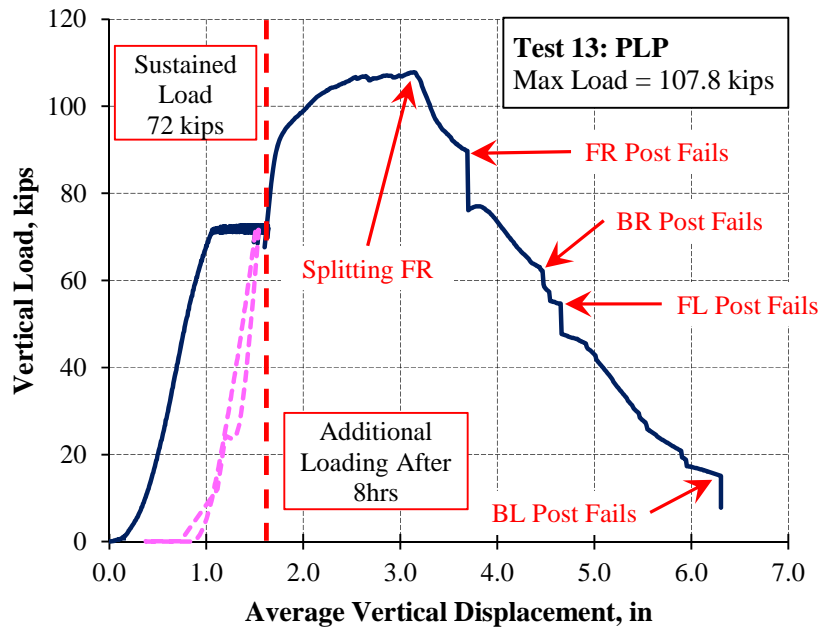
Infrequent creaking sounds could be heard during the initial loading sequence to 72kips, but these sounds did not increase in magnitude nor frequency as the load was increased. At 72kips, minor wedge cupping was observed beneath all four posts. Wedge cupping did increase slightly during the sustained loading period, but was not appreciable. Documented wedge cupping is presented below.



**Figure 5.80** Wedge Performance with 72kip Load A) Right Side at 0.0hrs  
B) Left Side at 0.0hrs C) Left Side at 8.0hrs

Loading of the specimen began at 9:00am and concluded at 5:00pm. At 2:00pm, an error occurred in the loading program controlling the actuators. The system was unloaded, re-equilibrated and the 72kip load reapplied. This unloading and reloading

period can be seen by the dotted magenta line on the load-displacement curve presented in Figure 5.81. Specimen 13 successfully completed the full 8hours under the sustained load of 72kips without any signs of failure. The total amount of vertical deformation under the sustained lateral load was 0.55in. Mild creaking sounds were heard throughout the test, but did not become serious.



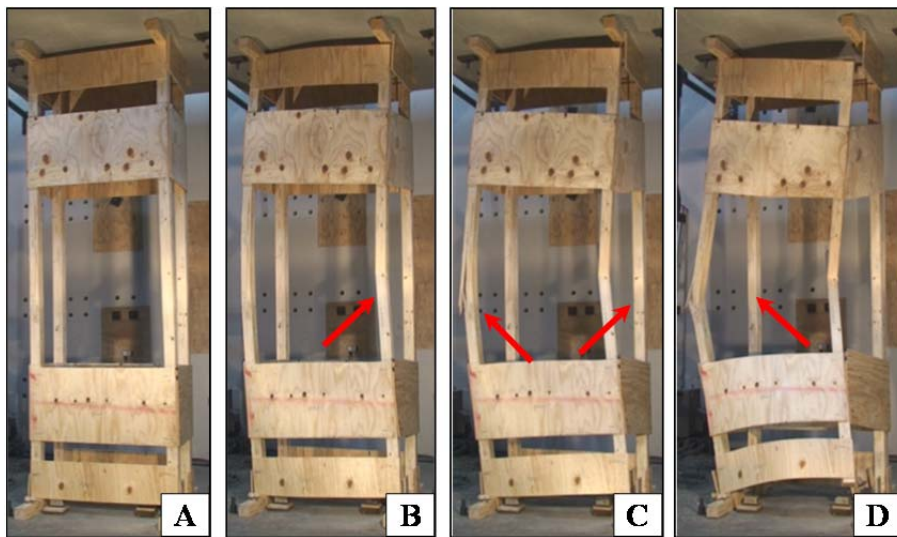
**Figure 5.81** Load-Displacement Curve for Specimen 13

After the 8hour mark was reached, the shore was loaded vertically to failure at a rate of 0.4in/min. During this additional loading, excessive cracking noises were heard starting at 90kips, and intensified thereafter. Wedge cupping increased during this additional loading phase.

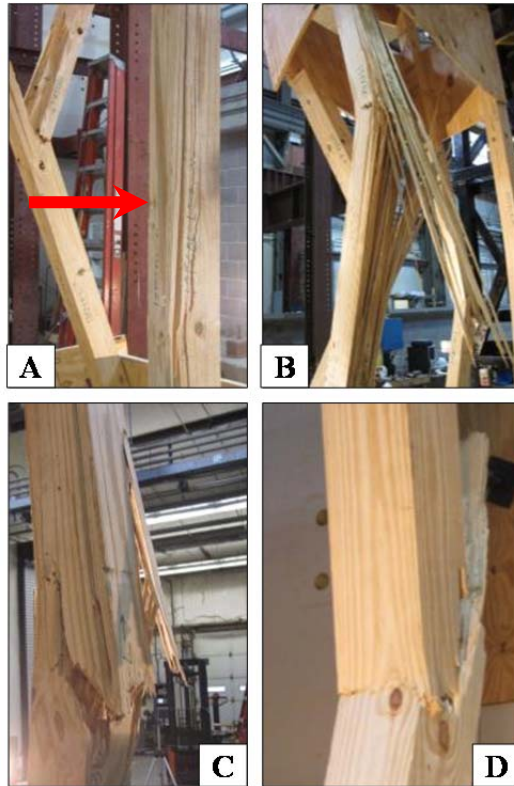
As the peak load of 107.8kips was reached, bearing of all four posts into their respective headers was noticeable. This was followed by the progressive longitudinal splitting of the front right post. The front right post was the first to rupture at



approximately 90kips, followed by the longitudinal splitting of the back right post at 63kips and fracturing of the front left post at 55kips. After these three failures, the shore continued to fold inward on itself towards the back left post, lifting the front right post off of the footer and down from the header. The back left post split longitudinally with the tension face towards the back at approximately 16kips. The progressive failure of the shore is displayed in Figure 5.82 as well as detailed photographs of the failures in Figure 5.83.



**Figure 5.82** Progressive Failures A) 72kips B) 1<sup>st</sup> Failure C) Front Left and Back Right Posts Fail D) Back Left Post Fails (End of Test)



**Figure 5.83** Post Failures A) Back Left B) Back Right C) Front Left  
D) Front Right

Many of the braces failed during the additional loading sequence. All four half gusset plates failed at their connections to the posts. In particular, the half gusset plate on the front right post was not adequate to keep the post attached to the footer. The first level intermediate braces on the left and right sides failed at their connection on the posts. The top plate on the right side connecting the posts to the right header also failed at both connections, with only the nails in the header holding the brace to the structure. Examples of these failures are presented in the figure below.



**Figure 5.84** Brace Failures A) 1<sup>st</sup> Level Brace on Right Side B) Top Plate on Right Side C) Gusset Plates on Right Side D) Gusset Plates on Left Side

Bearing and splitting of the headers was also observed during the post-test autopsy of specimen 13. The left header was noticeably crushed by the front left post, as well as split longitudinally starting at the back end and extending past the back left post. Splitting was also observed on the right header starting at the back right post and extending forwards approximately 12in. These bearing conditions are documented in Figure 5.85.



**Figure 5.85** Condition of the Headers A) Split Left Header (foreground) and Split Right Header (background) B) Bearing of Left Front Post into Left Header

## **CHAPTER 6**

### **Observations and Analysis**

This chapter provides more comprehensive observations, discussion and analysis of the tests on the wood shore systems described in Chapter 5. In particular, a summary of the testing results and how they relate to the research objectives are presented, as well as possible correlations between the behavior of the test specimens and the estimated design capacities presented in Chapter 2. As described in Chapter 2, the mechanical properties of wood show considerable variability, even within a particular wood species and visual grade. Due to the limited number of shores tested in this program, it was not possible to assess the effects of variability. Thus, observations made in this chapter on the impact of various design variables on shore capacity should be considered as preliminary in nature.

#### **6.1 SUMMARY OF CAPACITIES**

Table 6-1 presents a summary of the peak vertical loads sustained by each of the 13 specimens.

**Table 6-1** Summary of Vertical Capacities

Shore No.	Shore Type	Loading Scenario	Peak Capacity (kips)
1	PLP*	[A] Vertical Load Only	82
2	PLP	[A] Vertical Load Only	93
3	LP	[A] Vertical Load Only	86
4	LP	[A*] Vertical Load Only (force-controlled)	93
5	PLP*	[B] Cyclic Loading Under Two Levels of Vertical Load	68
6	LP	[C] Constant Lateral Displacement (6in) Increasing Vertical Load	65
7	PLP	[C] Constant Lateral Displacement (6in) Increasing Vertical Load	111
8	LP	[D] Constant Vertical Load (32kips), Increasing Lateral Displacement	40
9	PLP	[D] Constant Vertical Load (32kips), Increasing Lateral Displacement	45
10	LP*	[B] Cyclic Loading Under Two Levels of Vertical Load	49
11	LP	[B] Cyclic Loading Under Two Levels of Vertical Load	49
12	PLP	[E] Rapid Vertical Loading Only	90
13	PLP	[F] Sustained Vertical Load Only (72kips for 8hrs)	108

LP: Standard Laced Post Shore

LP\*: Laced Post Shore No.2 SYP

PLP: 5ft Clear Space Plywood Laced Post Shore

PLP\*: 4ft Clear Space Plywood Laced Post Shore

## 6.2 COMPARISON TO FEMA US&R TEST RESULTS

The data obtained from the FEMA StS-2 training tests (presented in *Chapter 2*) can be compared to the test specimens subjected only to vertical load (no imposed lateral load or lateral displacement). A key difference between the FEMA StS-2 specimens and the specimens tested in this current program is the species of wood used. FEMA StS-2 utilized douglas-fir-larch No.1 for all shoring towers, while all specimen tests conducted at The University of Texas at Austin's Ferguson Structural Engineering Laboratory (FSEL) were fabricated using No. 1 southern yellow pine. Table 6-2 and Table 6-3 compare similar LP and PLP shores from both investigations.

**Table 6-2** Comparison of Vertically Loaded LP Shore Capacities

	<b>Laced Post (LP) Reverse K, Vertical Load Only</b>		
	<b>Shore No.</b>	<b>Year Tested</b>	<b>Peak Capacity (kips)</b>
<b>FEMA Testing</b>	LP-1	2001	100
	LP-31	2005	103
	LP-51	2007	100
<b>UT FSEL</b>	3	2011	86
	4	2011	93

**Table 6-3** Comparison of Vertically Loaded PLP Shore Capacities

	<b>Plywood Laced Post (PLP), Vertical Load Only</b>		
	<b>Shore No.</b>	<b>Year Tested</b>	<b>Peak Capacity (kips)</b>
<b>FEMA Testing</b>	LP-52 (PLP)	2007	100
	LP-53 (PLP)	2007	88
	PLP-31	2005	88
	PLP-51	2007	90
	PLP-84	2010	120
	PLP-85	2010	140
<b>UT FSEL</b>	1	2011	82
	2	2011	93

In general, FEMA tested LP and PLP shores of similar design to those constructed in this research investigation produced higher vertical capacities than those tested at FSEL. This increase in capacity may be a result of the different species of wood used for the two sets of tests—Douglas-fir larch for FEMA and southern pine for UT- but there are too few tests in total to be able to make this claim firmly. As shown in *Chapters 2 and 4*, Douglas fir larch typically exhibits higher strength properties than southern yellow pine.

Another possibility for the difference in capacities is the amount of initial out-of-

plumb of the shore headers, which induced eccentricity into the system and may have affected capacity. The out-of-plumb values were not reported for the FEMA test specimens, and so the effect cannot be directly assessed.

The performance of FEMA specimens PLP-84 and PLP-85 are of particular interest since the new specifications for the PLP shores were based upon the designs of PLP-84, 85. However, the clear spacing between the intermediate braces in PLP-84,85 was 3ft, whereas the FOG PLP specifications require 5ft. FSEL specimen 1 had a clear space of 4ft and specimen 2 had 5ft of clear spacing. Neither of these specimens approached the 120kip capacity, but the 5-ft clear spacing did perform better than the 4ft based on the empirical data.

In general, the locations of failure noted in the FEMA investigation were commonly located at knots in the posts, usually near a node or brace connection. Failure at the knots was also observed as the typical location of failure during the FSEL investigation. However, it was difficult to accurately predict the specific knot that would induce failure on a single post, much less the location of the first failure for the overall structure. This highlights the danger of knots in the posts of emergency shoring towers, but the presence of knots is inevitable and must be dealt with in a cautious but practical manner. Recommended precautions include limiting or eliminating regions of posts that contain large spike knots, multiple knots clustered in one area, and knots larger than 2in in diameter.

Also similar to the US&R test observations, the majority of the failures in the shores tested at FSEL occurred in the region of the middle (2<sup>nd</sup>) bay of the shore. This includes the region between the intermediate braces in PLP towers, and between the 1<sup>st</sup> and 2<sup>nd</sup> level horizontal braces in the LP towers.

Fuse performance and connection failures will be compared and discussed later in this chapter.

### **6.3 EFFECTS OF NON-CYCLIC LATERAL DISPLACEMENT**

As with any column, loading eccentricities due to lateral offsets can have a

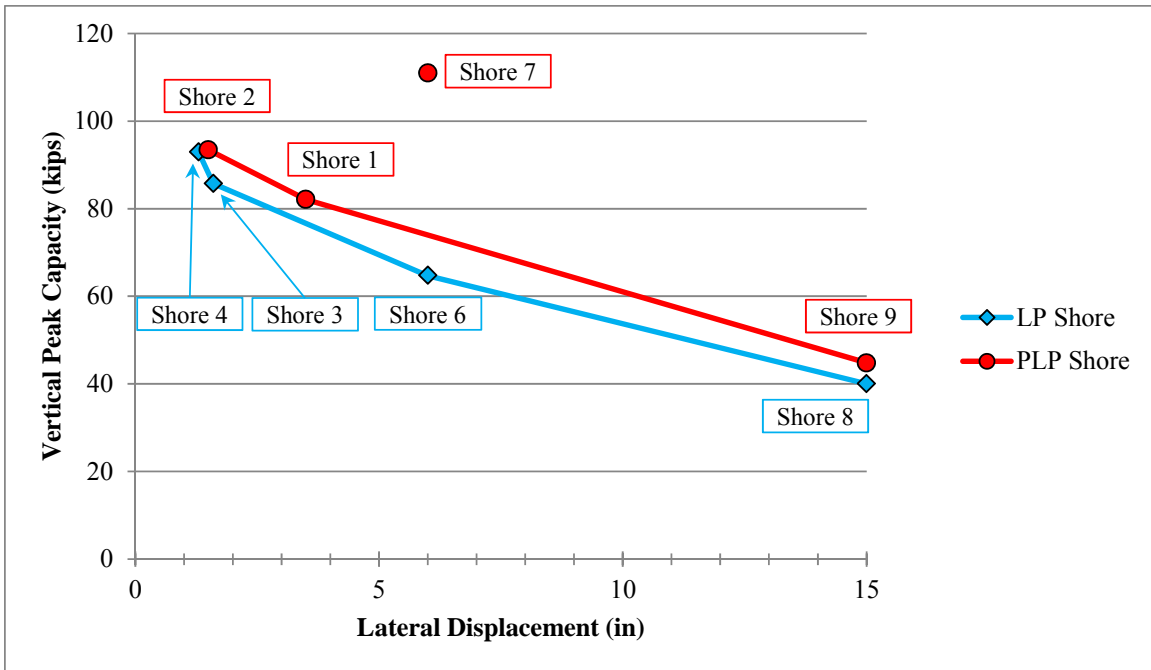


significant impact on total capacity due to P- $\Delta$  effects. Therefore it could be hypothesized that larger lateral displacements of the top of the shore would result in lower vertical load capacities. Four shoring towers were investigated under two types of non-cyclic lateral displacement loading scenarios, constant displacement of the top with increasing vertical load (load sequence C) and constant vertical load with increasing lateral displacement of the top (load sequence D). The results of these four tests are presented in Table 6-4.

**Table 6-4** Non-Cyclic Lateral Displacement Test Results

Shore No.	Shore Type	Loading Scenario	Peak Vertical Capacity (kips)	Max Induced Lateral Displ. (in)
6	LP	[C] Constant Lateral Displacement (6in) Increasing Vertical Load	65	6
7	PLP	[C] Constant Lateral Displacement (6in) Increasing Vertical Load	111	6
8	LP	[D] Constant Vertical Load (32kips), Increasing Lateral Displacement	40	15
9	PLP	[D] Constant Vertical Load (32kips), Increasing Lateral Displacement	45	15

Considering the average vertical peak capacity of a shore without induced lateral displacement was 89kips, it can be seen that with the exception of shore 7, vertical load capacity was reduced with a larger lateral displacement. Figure 6.1 presents a plot of the lateral displacement versus the peak vertical capacity for both LP and PLP shores utilizing the data obtained from shores 1-4 and 6-9. The lateral displacement for shores 1-4 is the initial out-of-plumb value prior to testing.



**Figure 6.1** Lateral Displacement versus Peak Capacity

As seen above, the PLP shore configuration maintained a higher vertical load capacity under lateral displacement than the LP configuration. This supports the US&R PLP design goal of providing a more robust shore. The test results also show that both LP and PLP towers still support a higher load than the design capacity of 32kips with up to a 15in. offset of the headers from the footers.

#### 6.4 EFFECTS OF CYCLIC LOADING

In addition to one directional lateral displacement, the effects of cyclic lateral loading were investigated. Load scenario B involved cyclically displacing the shore to amplitudes of  $\pm 2$ in. and  $\pm 4$ in. for 3 cycles each, under sustained vertical loads of 32kips and 48kips. The challenge with the small amplitudes and two-directional displacement was the initial out-of-plumb of each shore. This initial deformation uniquely impacted the actual displacement values achieved for each of the three shores tested. The results of these tests are presented in Table 6-5.

**Table 6-5** Cyclic Loading Test Results

Shore No.	Shore Type	Loading Scenario	Peak Vertical Capacity (kips)	Max Induced Lateral Displ. (in)
5	PLP*	[B] Cyclic Loading Under Two Levels of Vertical Load	68	4
10	LP*	[B] Cyclic Loading Under Two Levels of Vertical Load	49	4
11	LP	[B] Cyclic Loading Under Two Levels of Vertical Load	49	4

LP: Standard Laced Post Shore

LP\*: Laced Post Shore No.2 SYP

PLP\*: 4ft Clear Space Plywood Laced Post Shore

Shore 5 successfully completed all rounds of cyclic loading, and was then brought back to the initial equilibrium position and tested vertically to failure. Shores 10 and 11 both failed during the first 4in. cycle under the sustained 48kip ( $\pm 1$ kip) load.

The application of cyclic lateral displacement reduced the peak capacity of the shore compared to cases where vertical load only was applied. Further, the reduction in vertical capacity was significantly greater for cyclic lateral displacement than for a single application of lateral displacement in one direction only. This may be a result of accumulated damage under cyclic loading.

## 6.5 EFFECTS OF VERTICAL LOADING RATES

In actual field conditions, loading rates on a shore can vary greatly. Once a shore is installed, loads can be applied slowly over time as a damaged building settles, rapidly due to a sudden failure depositing debris within the tributary area of the shore, or somewhere in between. As discussed in *Chapter 2*, wood exhibits higher strengths when loaded rapidly, and lower strengths under sustained loads. Typically, to observe the full effects of this behavior loading would have to be applied very suddenly, or over many days or months. The rate and duration of load application in the laboratory was limited based on equipment limitations and safety concerns. Within these limitations, load scenarios E and F were created to represent rapid and sustained loading as well as maintain a practical and safe test. Both tests were conducted using only PLP shores, the

results of which are presented in Tables 6-6 and 6-7.

**Table 6-7** Loading Rate Test Results

Shore No.	Shore Type	Loading Scenario	Peak Capacity (kips)	Vert. Displ. At Peak Load (in)
12	PLP	[E] Rapid Vertical Loading Only	90	1.56
13	PLP	[F] Sustained Vertical Load Only (72kips for 8hrs)	108	3.13

**Table 6-6** Comparison of PLP Vertical Displacements at Peak Load

Shore No.	Shore Type	Loading Scenario	Peak Capacity (kips)	Vert. Displ. At Peak Load (in)
1	PLP*	[A] Vertical Load Only	82	1.43
2	PLP	[A] Vertical Load Only	93	2.03
5	PLP*	[B] Cyclic Loading Under Two Levels of Vertical Load	68	1.21
7	PLP	[C] Constant Lateral Displacement (6in) Increasing Vertical Load	111	1.91
9	PLP	[D] Constant Vertical Load (32kips), Increasing Lateral Displacement	45	0.92
12	PLP	[E] Rapid Vertical Loading Only	90	1.56
13	PLP	[F] Sustained Vertical Load Only (72kips for 8hrs)	108	3.13

PLP: 5ft Clear Space Plywood Laced Post Shore

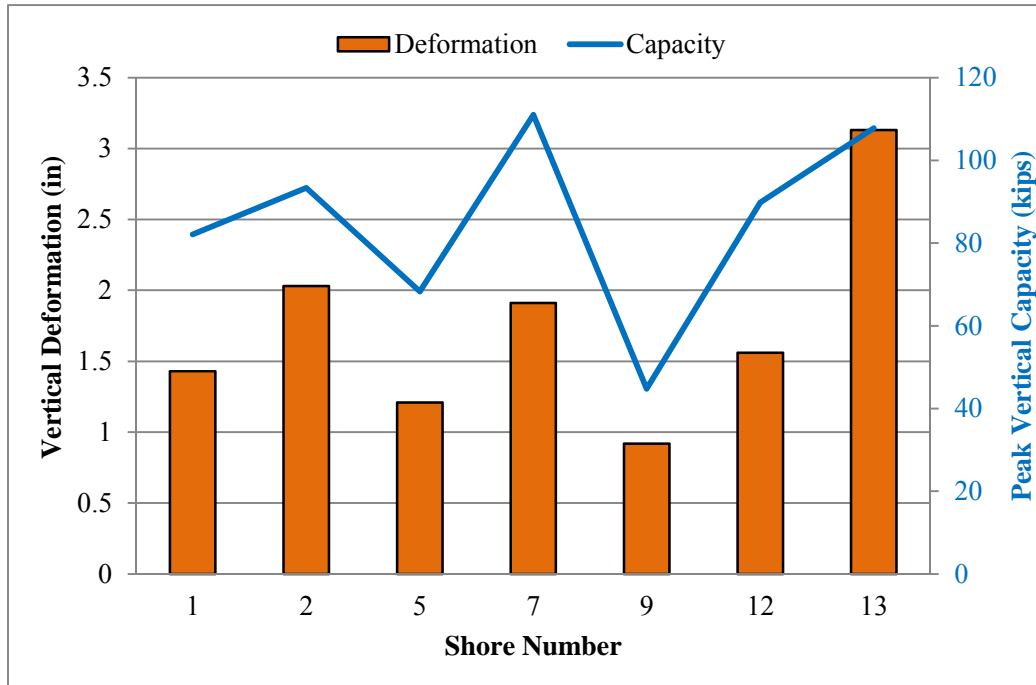
PLP\*: 4ft Clear Space Plywood Laced Post Shore

From the results tabulated above, the shore under sustained loading failed at 107.8kips after the 8-hr sustained test had been completed; much higher than the rapidly loaded shore. This single test cannot prove or disprove load duration effects, but rather shows the variability in capacities likely due to the innate variability of wood as a building material. What this test shows is the ability of a PLP shore to carry a substantial axial load with no ill effects for longer than traditional laboratory test conditions.

One important observation can be made utilizing the data from shores 12 and 13. In addition to loss of strength, wood is highly susceptible to creep under sustained loading, which was captured in the data obtained. Table 6-6 shows the amount of vertical displacement that each PLP shore underwent during each of the six loading scenarios.

Regardless of the magnitude of the peak vertical load, shore 13 displaced over an

inch more (54%) than the next largest value, 0.55in. of which occurred solely during the 8-hr sustained loading phase. Even shore 7, whose peak vertical load was higher than shore 13, deformed 1.2in. less than shore 13 (see Figure 6.2).



**Figure 6.2** Vertical Deformation Comparison of PLP Shore Specimens

Thus the presence and effects of creep on a shore over time can be substantial. This deformation may be of greater concern than the overall capacity of a shore under sustained loads given that shores in the field are often in service for many days. However, it should be considered that shore 13 was loaded with 72kips, over twice the design capacity, and lower sustained loads should result in lower creep deformations.

## 6.6 IMPACT OF INITIAL OUT-OF-PLUMB

The impact of the initial out-of-plumb of a shore was an issue considered in the analysis of the experimental data. Ideally, all constructed shores would be plumb in both directions, but can be difficult to achieve. This was the case during the construction of

the specimens for this investigation. The initial nine specimens were constructed with the aid of a US&R shoring expert. The alignment of each shore was checked and adjusted prior to completion, but all had some level of out-of-plumb. In the weeks that followed, drying shrinkage warped the shores increasing the misalignment. Therefore it is of great importance to know at what level of out-of-plumb the shore begins to lose capacity, and the magnitude of the capacity lost.

All vertically loaded only shores and shores 6 and 7, which in essence had a forced initial out-of-plumb, were analyzed for the impact of their initial imperfect alignment. The results are compiled in Table 6-8, which shows the peak capacity as well as the initial out-of-plumb of each shore in each plane. Also included in the table is the direction that the shore buckled, which corresponds to the tension face of the post at buckling (the face that bowed out and fractured).

**Table 6-8** Initial Out-of-Plumb Comparison Data

Shore No.	Shore Type	Loading Scenario	Peak Capacity (kips)	Failure (Buckling) Direction	Avg. Out-of-Plumb	
					Front-Back (in)	Left - Right (in)
1	PLP*	[A] Vertical Load Only	82	Forward	1.6 F	3.5 L
2	PLP	[A] Vertical Load Only	93	Forward	1.8 F	1.5 L
3	LP	[A] Vertical Load Only	86	Forward	0.5 F	1.6 L
4	LP	[A*] Vertical Load Only (force-controlled)	93	Right	0.1 B	1.3 L
6	LP	[C] Constant Lat.Displ. (6in L), Inc Vert Load	65	Left	0.6 F	6.0 L
7	PLP	[C] Constant Lat.Displ. (6in L), Inc Vert Load	111	Back	2.3 B Twist	6.0 L
12	PLP	[E] Rapid Vertical Loading Only	90	Forward	0.8 F	0.9 L
13	PLP	[F] Sustained Vert Load Only (72kips for 8hrs)	108	Back	0.3 F	1.0 L

LP: Standard Laced Post Shore

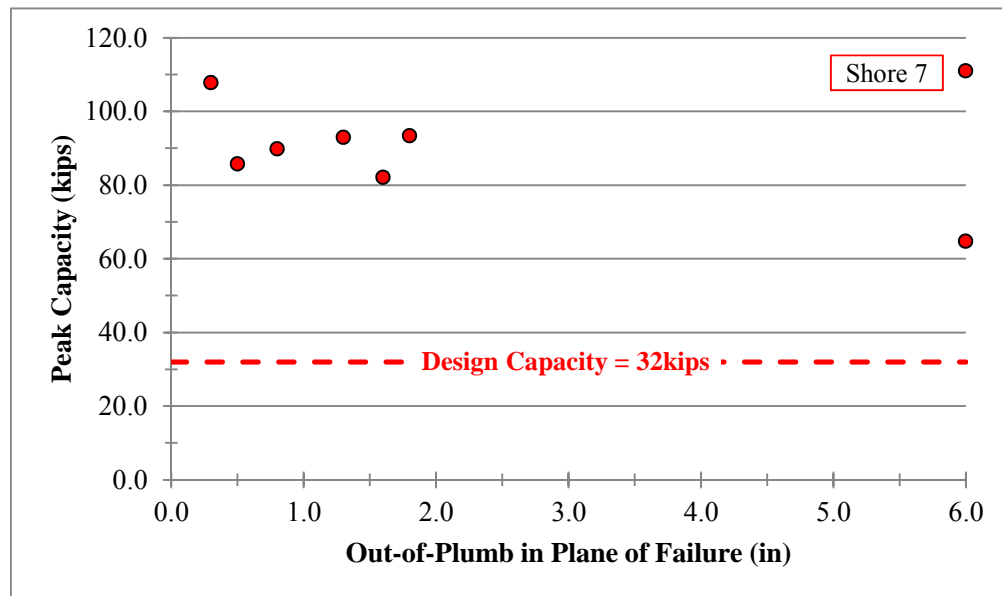
PLP: 5ft Clear Space Plywood Laced Post Shore

PLP\*: 4ft Clear Space Plywood Laced Post Shore

In looking at the data and failure direction, it is clear that the out-of-plumb does not necessarily dictate the direction of failure of the shore. For example, shore 1 had a considerably larger misalignment in the left-to-right plane, but buckled forwards. This failure was more likely due to a local weak point (knot) in the post rather than the

eccentricity caused by the initial out-of-plumb. Shore 7 seems to be an outlier in this category as well, since both the initial and induced out-of-plumb directions were large in magnitude, but this did not seem to affect the capacity.

The data in Table 6-8 is plotted in Figure 6.3 for the plane of failure. Excluding the outlier point from shore 7, it is evident that even up to an initial out-of-plumb of 6.0in., a shore can maintain a vertical load of twice the design capacity.



**Figure 6.3** Peak Capacity versus Misalignment

Realistically, a properly constructed shore should not exceed an initial out-of-plumb of 2.0in., especially if warping due to the drying of the wood prior to loading is not a factor. From the data, both the PLP and LP shores maintained a peak carrying capacity of over 80.0kips with up to a 2.0in. initial misalignment, a factor of safety of 2.5.

### **6.7 PERFORMANCE OF LACED POST (LP) VERSUS PLYWOOD LACED POST (PLP)**

A primary goal of this research was to compare the performance of both the LP and PLP shore configurations in non-ideal loading conditions. The LP and PLP shores are compared in three different areas of interest below.

### 6.7.1 Comparison of Vertical Capacity

The capacity of each shore in each loading scenario was considered and compiled in Table 6-9. As seen below, in all categories the PLP outperformed the LP shore.

**Table 6-9** Comparison of Non-ideal Loading Sequence Results for LP and PLP

	Vertical Load Only		6.0in Lat Displ		15in Lat Displ		Cyclic Loading	
	Max Capacity (kips)		Max Capacity (kips)		Max Capacity (kips)		Max Capacity (kips)	
LP	93	✓	65	✓	40	✓	49	✓
PLP	93	✓	111	✓	45	✓	68	✓

However, additional tests should be conducted to provide additional data due to the nature of wood as a highly variable material. The tests conducted for this research typically involved one LP and one PLP specimen per loading scenario, not enough to conclude that one configuration is superior to the other.

### 6.7.2 Comparison of Lateral Stability

The PLP shore was designed to be more stable for lateral loading conditions as well as vertical gravity loads. The force required to laterally displace both the LP and PLP shores (PLP in the strong, 4ft direction) can be used as a gage of stiffness in the lateral direction. For the one-directional lateral tests, the maximum force required to displace the shore was only applied in one direction whereas in the cyclic tests, the maximum force could have been in either direction. These forces are compiled in Table 6-10 for each lateral test.

**Table 6-10** Force Required to Displace Laterally

	6.0in Lat Displ		15in Lat Displ		Cyclic Loading	
	Max Lat Force Req (kips)		Max Lat Force Req (kips)		Max Lat Force Req (kips)	
LP	0.4	✓	5.3	✓	3.6	✓
PLP	1.3	✓	5.2		3.5	




The 6.0in. lateral displacement value of 1.3kips correlates to PLP shore 7, which has been deemed an outlier with a peak capacity of 111.0kips. The 6.0in. loading scenario also involved displacing the tower prior to applying a vertical load, which explains the considerably smaller loads required to displace the shore. The 15in. and cyclic values are much higher because a load of 32kips (or 48kips for cyclic) was also being applied as the shore was laterally displaced. Therefore from the data in Table 6-10, it can be observed that under the 32kip design load, the ability of the LP and PLP shore to resist lateral displacement is relatively equivalent. It is also clear from the data that both the LP and PLP shores have very low lateral stiffness and strength.

### 6.7.3 Comparison of Cyclic Load Performance

The cyclic loading scenario provided a means of observing the performance of the nailed connections in the towers. Since the loads were not relatively low, the success or failure of the braces was key to the performance of the shore. One PLP (4ft clear spacing) and two LP towers, one of which was specimen 10 (No.2 lumber), were tested under this loading scenario. The results of the individual load phases are listed in Table 6-11.

**Table 6-11** Cyclic Loading Sequence Performance Comparison

	32kip Applied Load		32kip Applied Load		Additional Vert Load (kips)
	± 2in Cycles	± 4in Cycles	± 2in Cycles	± 4in Cycles	
<b>LP* #10</b>	3 Cycles	3 Cycles	3 Cycles	< 1 Cycle	NA
<b>LP #11</b>	3 Cycles	3 Cycles	3 Cycles	< 1 Cycle	NA
<b>PLP* #5</b>	3 Cycles	3 Cycles	3 Cycles	3 Cycles	68.3 

LP: Standard Laced Post Shore

LP\*: Laced Post Shore No.2 SYP

PLP\*: 4ft Clear Space Plywood Laced Post Shore

As shown above, the PLP tower not only successfully completed all four rounds of cyclic loading, but then carried a total vertical load of 68.3kips. Both LP towers failed

prior to completing their first full 4in cycle under the 48kip applied load.

The success of the PLP tower can likely be attributed to the performance of the plywood braces and their respective connections. A 14-nail connection on a PLP could still provide significant support even if half the connections had pulled out, whereas the LP braces only had a 3-nail connection to rely upon. However, again with only three specimens to analyze, additional testing should be performed before concluding the superiority of the PLP under cyclic conditions.

## **6.8 PERFORMANCE AND RELIABILITY OF EMERGENCY FUSES**

As discussed in previous chapters, trained emergency shoring personnel utilize three major fuses to detect overload of an installed shoring tower. These three fuses are cupping of the wedges under each post, audible wood cracking or creaking sounds, and splitting of the headers (or footers). Ideally, all three fuses would not only be present but prevalent such that the signs of distress would be obvious to emergency personnel. The performances of these three fuses were qualitatively analyzed for each of the 13 specimens and the results listed in Table 6-12.

**Table 6-12** Qualitative Analysis of Emergency Fuses

Shore No.	Shore Type	Loading Scenario	Peak Capacity (kips)	Wedge Cupping	Audible Wood Noises	Splitting of Headers
1	PLP*	[A] Vertical Load Only	82	2 of 4 Major	Major	NO
2	PLP	[A] Vertical Load Only	93	Major	Major	NO
3	LP	[A] Vertical Load Only	86	1 Mod. 3No	Major	NO
4	LP	[A*] Vertical Load Only (force-controlled)	93	Minor	Not until 70k	NO
5	PLP*	[B] Cyclic Loading with 32k and 48k	68	NO	Moderate	NO
6	LP	[C] Constant Lat.Displ. (6in L), Inc Vert Load	65	NO	Minor	NO
7	PLP	[C] Constant Lat.Displ. (6in L), Inc Vert Load	111	Major	Major +45k	NO
8	LP	[D] Constant Vert. Load (32k), Inc Lat. Displ.	40	NO	Moderate	NO
9	PLP	[D] Constant Vert. Load (32k), Inc Lat. Displ.	45	NO	Moderate	NO
10	LP*	[B] Cyclic Loading with 32k and 48k	49	Minor	Minor	NO
11	LP	[B] Cyclic Loading with 32k and 48k	49	NO	Minor	NO
12	PLP	[E] Rapid Vertical Loading Only	90	Major	Moderate	Yes-Bearing
13	PLP	[F] Sustained Vert Load Only (72kips for 8hrs)	108	Minor	Moderate	Major

LP: Standard Laced Post Shore

LP\*: Laced Post Shore No.2 SYP

PLP: 5ft Clear Space Plywood Laced Post Shore

PLP\*: 4ft Clear Space Plywood Laced Post Shore

Those fuses that were apparent and obvious to the test observers are colored red. As can be seen, the fuses were very inconsistent and splitting of the headers was almost entirely absent. Audible sounds of distress were the only consistently observed fuse, but frequency and intensity of these noises was inconsistent and possibly not enough to alert emergency personnel in a loud disaster zone. Thus, in these tests, the fuses did not provide a consistent and reliable warning of overload or impending failure of the shore.

One consistent data observation that may provide a means of an alternative warning device was the amount of vertical deflection that each shore experienced. Shown in Table 6-13 is the total amount of vertical displacement of the top of the shore relative to the bottom at the time of maximum vertical capacity.

**Table 6-13 Vertical Deformations at Peak Capacity**

Shore No.	Shore Type	Loading Scenario	Peak Capacity (kips)	Vert. Displ. At Peak Load (in)
1	PLP*	[A] Vertical Load Only	82	1.43
2	PLP	[A] Vertical Load Only	93	2.03
3	LP	[A] Vertical Load Only	86	1.64
4	LP	[A*] Vertical Load Only (force-controlled)	93	1.86
5	PLP*	[B] Cyclic Loading Under Two Levels of Vertical Load	68	1.21
6	LP	[C] Constant Lateral Displacement (6in) Increasing Vertical Load	65	1.03
7	PLP	[C] Constant Lateral Displacement (6in) Increasing Vertical Load	111	1.91
8	LP	[D] Constant Vertical Load (32kips), Increasing Lateral Displacement	40	0.95
9	PLP	[D] Constant Vertical Load (32kips), Increasing Lateral Displacement	45	0.92
10	LP*	[B] Cyclic Loading Under Two Levels of Vertical Load	49	1.30 <sup>a</sup>
11	LP	[B] Cyclic Loading Under Two Levels of Vertical Load	49	1.05 <sup>a</sup>
12	PLP	[E] Rapid Vertical Loading Only	90	1.56
13	PLP	[F] Sustained Vertical Load Only (72kips for 8hrs)	108	3.13

<sup>a</sup> Vertical displacement at approximate point of initial failure

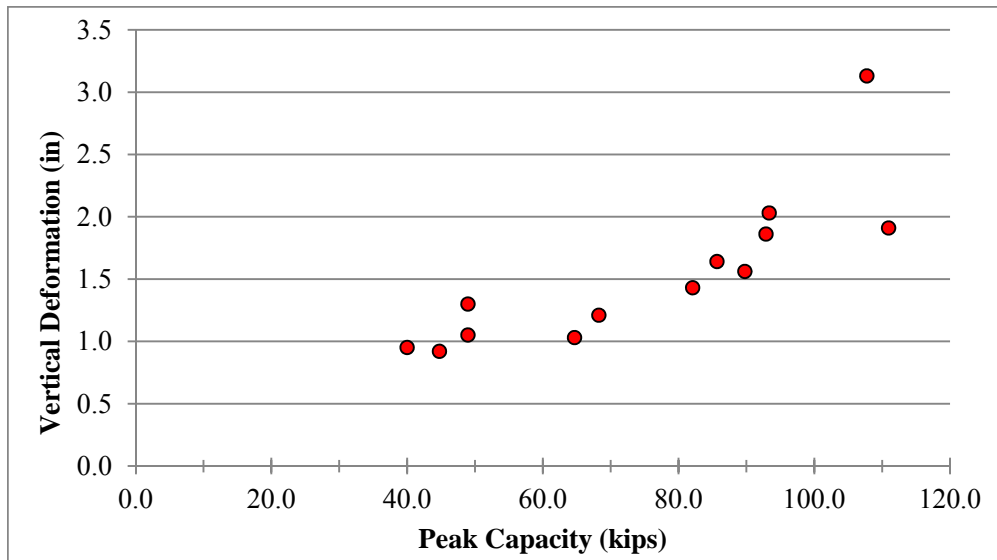
LP: Standard Laced Post Shore

LP\*: Laced Post Shore No.2 SYP

PLP: 5ft Clear Space Plywood Laced Post Shore

PLP\*: 4ft Clear Space Plywood Laced Post Shore

The least amount of vertical deformation at peak capacity was 0.92in. during the 15in. lateral displacement test. While it is clear that the exact amount of displacement does not always approximate the load on the shore (shores 7 and 13), the two are related. Figure 6.4 is a graphical representation of the amount of vertical deformation to the peak load at which the deformation was recorded.



**Figure 6.4** Vertical Deformation at Peak Capacity

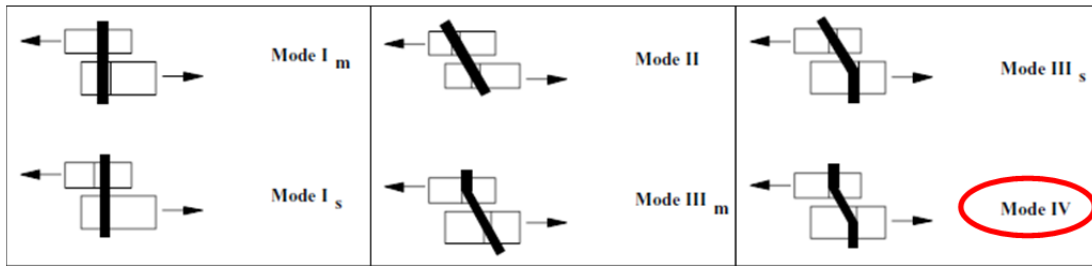
Figure 6.4 shows some relationship between the maximum load on the tower and the amount of vertical deformation the tower has undergone regardless of the horizontal displacement. Therefore a fuse that captures the amount of relative vertical displacement of the header to the footer may provide a more accurate and consistent means of early warning of failure. Load displacement plots for the entire testing sequence for each specimen are provided in *Chapter 5*.

## 6.9 CONNECTION FAILURES

*Section 2.6.1* in the *Background Study* provided design calculations to predict the connection failures in shear for both the 2x4 and plywood brace connections. The observations during testing will be compared to the calculations from *Chapter 2* for each type of brace below.

### 6.9.1 LP Brace Connection Failures

From the design calculations using the NDS 2005, the controlling shear yield mode of the nails in the 2x4 connection was Mode IV, a double curvature failure shown in Figure 6.5.



**Figure 6.5** LP Controlling Single Shear Yield Modes (NDS 2005)

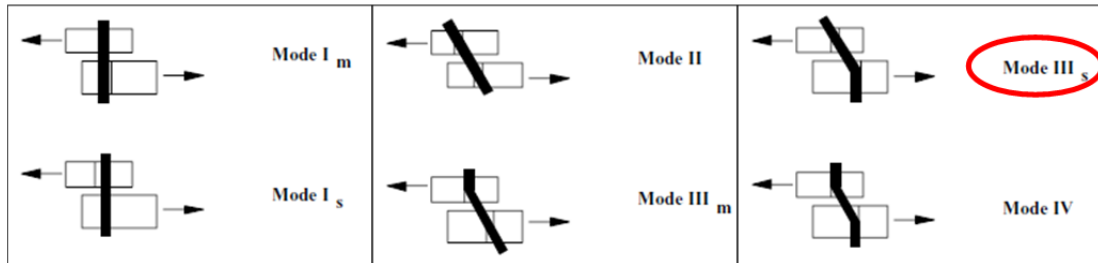
This type of nail failure was commonly observed in the post-test autopsies, but was not the only connection failure mode documented. Failure modes II, III<sub>m</sub> and III<sub>s</sub> were also observed as well as pullout and splitting of the brace. The exact initial failure modes of the braces were difficult to observe because most of the failed braces also eventually pulled the nails out of the posts, bending the nails. However, signs of double curvature that correspond to Mode IV were observed and an example is shown in Figure 6.6. All brace failures are documented in *Chapter 5* along with photographs of the nail failures.



**Figure 6.6** Example of Yield Mode IV from Specimen 8

## 6.9.2 PLP Brace Connection Failures

From the design calculations using the NDS 2005, the controlling shear yield mode of the nails in the plywood brace connection was Mode III<sub>s</sub> (side member yielding) shown in Figure 6.7.



**Figure 6.7** PLP Controlling Single Shear Yield Mode (NDS 2005)

Yield Mode III<sub>s</sub> shows a rigid rotation within the side member (plywood brace) while the shaft within the post remains relatively straight. As mentioned in the LP section above, the majority of the brace failures displaced enough to separate the nail from either the post or the brace itself. Also like the LP brace failures, the predicted yield mode (Mode III<sub>s</sub>) was commonly observed in the post-test autopsies, but was not the sole failure mode. Modes III<sub>m</sub> and IV were also observed as well as withdrawal failures and plywood tear out failures. An example of a Mode III<sub>s</sub> failure is shown in Figure 6.8. All brace failures are documented in *Chapter 5* along with photographs of the connection failures.



**Figure 6.8** Example of Yield Mode III<sub>s</sub> from Specimen 1

Each brace failure was unique in many ways, but the predicted yield modes for both the LP and PLP brace connections were frequently observed. Failure modes were influenced by many factors including specific gravities of the side and main members as well as the forces exerted on the connection. These variables made predicting the connection failures very difficult.



## CHAPTER 7

### Conclusions

This thesis has presented the results of an experimental research program on the structural performance of wood shoring systems used by Urban Search & Rescue (US&R) teams for temporarily stabilizing damaged buildings. This research was intended to build upon and extend the results of previous tests on wood shoring systems, conducted largely as part of US&R training programs. This current research evaluated both Laced Post (LP) and Plywood Laced Post (PLP) shores. The design of the shores was in largely in accordance with the US&R *Field Operations Guide* (FOG), but also included some design modifications currently under consideration for the FOG. According to the FOG, the shores are intended to have a safe vertical load carrying capacity of 32kips.

A total of thirteen shores were tested in this research. All of the shores were 13ft. in height and all were constructed using southern yellow pine wood. Twelve of the thirteen shores were constructed of wood specified as Number 1 grade southern yellow pine. One shore was constructed of wood specified as Number 2 grade southern yellow pine. Shores were tested under vertical load only, under lateral load only, and under combined vertical and lateral load. For lateral loading, some shores were tested under monotonic lateral load (lateral load applied in one direction only) and some were tested under cyclic lateral loading.

Important observations from this testing program are discussed below. Due to schedule and budget restrictions, no replicate tests were conducted for any given loading scenario. Considering the intrinsic high variability in structural properties of wood, testing of a significant number of replicate specimens is highly desirable in order to characterize variability in structural response, and to provide supplemental data for analytical models. Consequently, the observations made below should be considered preliminary in nature, and subject to verification by further testing.

## 7.1 BEHAVIOR UNDER VERTICAL LOADING

Some key observations from tests on shores subjected only to vertical loading:

- Shores tested under vertical load only showed vertical load capacities that ranged from 82 to 108kips. Compared to the 32-kips design vertical capacity, these shores provided factors of safety against collapse ranging from about 2.5 to 3.4.
- The vertical capacities of the shores tested in this program were about 15 to 20-percent lower than vertical capacities measured in previous US&R shore tests. The reason for this difference is unclear, but is conjectured to be the result, in part, of the type of wood used to build the shores. Previous US&R tests were on shores constructed using No. 1 Douglas fir-larch. The current tests were on shores constructed using No. 1 southern yellow pine (one shore used No. 2 southern yellow pine). Based on published mechanical properties, Douglas fir-larch is expected to have somewhat higher bearing strength than southern yellow pine. The results of these tests suggest that when Douglas fir-larch is not available to a US&R team, southern yellow pine provides a reasonable alternative.
- Based on the results of these tests, the vertical capacity measured for a shore in a test is not affected by using “load control” versus “displacement control.” Consequently, both types of loading can be used to measure the vertical capacity of a shore. Displacement control testing provides information on the structural response of the shore after reaching its peak vertical capacity, providing insights into the ductility of the shore under vertical loading.
- Under vertical loading alone, the shores exhibited only very limited ductility after reaching their peak vertical capacity. That is, after reaching the peak vertical capacity, the shores lose their load carrying capability quite rapidly. This limits the ability of an overloaded shore to redistribute

loads to other nearby shores. This also suggests the need to a reasonable factor of safety on vertical load, as is currently used, since essentially complete collapse of a shore occurs once its capacity has been reached.

## **7.2 BEHAVIOR UNDER LATERAL AND COMBINED VERTICAL/LATERAL LOADING**

Some key observations from tests on shores subjected to lateral loading, or combined lateral and vertical loading:

- All of the shores tested in this program showed very low lateral stiffness and strength. The peak lateral loads resisted by the shores were on the order of 3 to 5kips with very low values of lateral stiffness. Consequently, these shores should not be used to resist lateral loads on a building. Because of their low lateral stiffness and strength, the shores will do very little to resist relative lateral movement of the floors of a building.
- Though the shores have little lateral stiffness and strength, the shores can accommodate large lateral displacements and still hold substantial vertical loads. The shores are therefore quite tolerant of lateral movement between the top and bottom of the shore. This was the case for both monotonic and cyclic lateral displacements. For example, some shores were monotonically displaced laterally as much as 15-inches (lateral displacement about equal to 10-percent of the shore height) but still held vertical loads of about 40kips. In terms of being able to support substantial vertical loads in the presence of large monotonic or cyclic lateral displacements, the PLP shores were somewhat better than the LP shores.
- The ability of the shores to tolerate large lateral displacements also means the shore vertical capacity is not highly sensitive to initial out-of-plumb of the shore. PLP and LP shores maintained a peak carrying capacity of over 80kips with up to a 2.0-inch initial misalignment, a factor of safety of 2.5.

Limiting the initial out-of-plumb to less than about 2.0 inches in either direction appears to be a reasonable criterion to guide construction of shores. However, as noted above, even if the initial out-of-plumb exceeds 2.0 inches, the shore will still have substantial vertical capacity.

### **7.3 LACED POST (LP) VERSUS PLYWOOD LACED POST (PLP) DESIGN**

A key research objective for this investigation was to experimentally compare the structural performance of the LP shore with the PLP shore. For all loading conditions considered in this program, the PLP shore performed as well as, or in most cases, better than, the LP shore. The PLP shores, in particular, show a better performance under combined lateral and vertical loading. Also, a limited number of tests considered PLP shores with either a 4-ft or 5-ft clear spacing between plywood braces in the central portion of the shore. It appears that the use of a 5ft spacing is preferable compared to the 4ft spacing.

The practical application of this observation is the ability to confidently use the PLP as a standard Class 3 shore in disaster scenarios. The 2ft x 4ft PLP shore utilizes standard sized braces, shorter nails and a smaller footprint while producing a higher capacity and a higher level of lateral stability (in the strong 4ft dimension). This design, in comparison to the standard reverse K LP shore, is more efficient, faster to fabricate and easier to install.

### **7.4 PERFORMANCE AND RELIABILITY OF EMERGENCY FUSES**

As discussed in previous chapters, trained emergency shoring personnel utilize three major fuses to detect overload of an installed shoring tower. The manifestations of the three fuses are cupping of the wedges under each post, audible wood cracking or creaking sounds, and splitting of the headers (or footers). Ideally, all three fuses would not only be present but prevalent such that the signs of distress would be obvious to emergency personnel. The performances of these three fuses were qualitatively analyzed for each of the 13 specimens. Only audible cracking sounds of the wood was consistently

present in all 13 shores, but varied greatly in frequency and intensity. Thus, in a loud disaster scenario, this fuse may not be obvious enough to attract the attention of emergency personnel.

Cupping of the wedges and splitting of the headers was found to be very inconsistent, if present at all. When cupping or splitting did occur, it was fairly noticeable and should be enough to attract attention. However, the lack of reliability gives reason for concern, and it is the conclusion of this investigation that an additional method of overload detection be investigated.

## **7.5 FURTHER RESEARCH NEEDS**

Wood is a highly variable material, which when paired with a fabrication process that is often focused on rapid production, can produce highly variable results. While the data obtained in this investigation indicated some clear trends in the structural behavior of LP and PLP shores, the number of tests were not adequate to evaluate the variability in various measures of structural performance, such as vertical load capacity, or behavior under combined vertical and lateral loads. Additional tests would be desirable to confirm the behavioral trends observed in these tests and to better establish quantitative measures of variability as well as provide data for analytical models.

Wood properties also vary in different species of wood. The US&R training manuals specify desired species and grades for the lumber used, but in a disaster scenario, available species and grades of lumber may be limited. Therefore further investigations involving different species and more importantly lower grades of lumber are needed. Testing lower grades of lumber can also provide a lower bound of data for the different shoring tower configurations.

The FOG specifications also include designs for shores up to 17ft for 4x4 posts and 20ft for 6x6 post configurations. These tall towers are rarely used in practice, but if needed would be a critical element in the shoring system of the structure. Taller towers may potentially produce lower capacities due to the increased post lengths and therefore increased spans susceptible to buckling. This coupled with the possibility of requiring

splices for the posts to attain such heights, is an area that requires additional investigation. The use of 6x6 posts was not included in this research investigation, but is an area in need of further investigation. The 6x6 laced post shore also utilizes 2x6 lumber for the brace rather than the standard 2x4. The FOG design load of a 6x6 shore (LP or PLP) is 80kips compared to the 4x4 design load of 32kips. Tests are needed to evaluate the capacity and behavior of 6x6 shores.

The 16d sinker nails (12d common) used to construct the shores for this test program were difficult to obtain. This specific nail size was not available at local hardware stores and was specially ordered from the manufacturer for this investigation. Therefore, the importance of this specific sized nail in the LP shore is an area that could benefit from further investigation. Nails that are the same length as a 16d nail but with a smaller (8d) diameter may be more readily at local hardware stores and may be easier to obtain in a disaster scenario. The behavior of the shores using different nails should be investigated.

The creep effects in the sustained (8hr) test were considerable and could dramatically impact the overall capacity of a shore over time. A longer test was not conducted due to laboratory safety constraints, but should be an area of further investigation. Since shores are typically in use for days or even months, long term sustained loading effects is an area of importance.

Additionally, the effect of impact loading on the shores is an issue of interest. In a damaged structure, there is a possibility of a structural element failing suddenly or debris shifting. Behavior of shores under such loading impacts should be investigated.

## APPENDIX A

### Design Calculations for Shores and Connections

#### A1. Bearing Capacity: Southern Yellow Pine No. 1 Dense

$$R_{c\perp} = F'_{c\perp} \times A_g \quad \text{Eq. 1}$$

Where:  $R_{c\perp}$ : Design Compression Force Perpendicular to Grain (per post)  
 $F'_{c\perp}$ : Adjusted Design Compression Stress Perpendicular to Grain  
 $A_g$ : Gross Area of Bearing

$$F'_{c\perp} = F_{c\perp} \times C_M \times C_t \times C_i \times C_b \times K_F \times \phi_c \times \lambda \quad \text{Eq. 2}$$

Where:  $F_{c\perp}$ : Reference Design Compression Stress Perpendicular to Grain  
 $C_M$ : Wet Service Adjustment Factor  
 $C_t$ : Temperature Adjustment Factor  
 $C_i$ : Incising Adjustment Factor  
 $C_b$ : Bearing Area Adjustment Factor  
 $K_F$ : LRFD Format Conversion Factor  
 $\phi_c$ : Resistance Factor  
 $\lambda$ : Time Effect Factor = 0.6 (Conservative)

(Note: All 'C' Adjustment Factors for Experimental Conditions = 1.0)

$$F_{c\perp} = 660 \text{psi} \quad (\text{NDS 2005 TBL 4B})$$

From Equation 2:  $F'_{c\perp} = 660 \times 1.0 \times 1.0 \times 1.0 \times 1.0 \times 1.875/\phi \times \phi \times 0.6$   
 $F'_{c\perp} = 742.5 \text{psi}$

From Equation 1:  $R_{c\perp} = F'_{c\perp} \times A_g = 742.5 \text{psi} \times 3.5 \text{in} \times 3.5 \text{in} = 9096 \text{lbs}$   
 $R_{c\perp} = 9.1 \text{kips/post} \times 4 \text{posts}$

$$\underline{\text{Total Capacity} = 36.4 \text{ kips}}$$

**A2. Bearing Capacity: Southern Yellow Pine No. 1 (Used in this Investigation)**

$$F_{c\perp} = 565 \text{ psi} \quad (\text{NDS 2005 TBL 4B})$$

From Equation 2:  $F'_{c\perp} = 565 \times 1.0 \times 1.0 \times 1.0 \times 1.0 \times 1.875 / \phi \times \phi \times 0.6$

$$F'_{c\perp} = 635.6 \text{ psi}$$

From Equation 1:  $R_{c\perp} = F'_{c\perp} \times A_g = 635.6 \text{ psi} \times 3.5 \text{ in} \times 3.5 \text{ in} = 7786.4 \text{ lbs}$

$$R_{c\perp} = 7.8 \text{ kips/post} \times 4 \text{ posts}$$

$$\underline{\text{Total Capacity} = 31.1 \text{ kips}}$$

**A3. Bearing Capacity: Douglas Fir-Larch No. 1**

$$F_{c\perp} = 625 \text{ psi} \quad (\text{NDS 2005 TBL 4A})$$

From Equation 2:  $F'_{c\perp} = 625 \times 1.0 \times 1.0 \times 1.0 \times 1.0 \times 1.875 / \phi \times \phi \times 0.6$

$$F'_{c\perp} = 703 \text{ psi}$$

From Equation 1:  $R_{c\perp} = F'_{c\perp} \times A_g = 703 \text{ psi} \times 3.5 \text{ in} \times 3.5 \text{ in} = 8613.3 \text{ lbs}$

$$R_{c\perp} = 8.6 \text{ kips/post} \times 4 \text{ posts}$$

$$\underline{\text{Total Capacity} = 34.4 \text{ kips}}$$

**A4. Buckling Capacity: Southern Yellow Pine No. 1 (Used in this Investigation):**

$$\mathbf{F'_c = F_c \times C_M \times C_t \times C_F \times C_i \times C_P \times K_F \times \phi_c \times \lambda} \quad \mathbf{Eq. 3}$$

Where:  $F'_c$ : Adjusted Design Compression Stress Parallel to Grain

$F_c$ : Reference Design Compression Stress Parallel to Grain

$C_M$ : Wet Service Adjustment Factor = 1.0



$C_t$ : Temperature Adjustment Factor = 1.0

$C_F$ : Size Adjustment Factor (Included in  $F_c$  for SYP)

$C_i$ : Incising Adjustment Factor = 1.0

$C_P$ : Column Stability Adjustment Factor

$K_F$ : LRFD Format Conversion Factor

$\phi_c$ : Resistance Factor

$\lambda$ : Time Effect Factor = 0.6 (Conservative)

$$F_c = 1850 \text{ psi} \quad (\text{NDS 2005 TBL 4B})$$

$$C_D = 0.9 \quad (\text{Dead Load – Conservative})$$

$$C_P = \frac{1 + (F_{cE}/F_c^*)}{2c} - \sqrt{\left[ \frac{1 + (F_{cE}/F_c^*)}{2c} \right]^2 - \frac{(F_{cE}/F_c^*)}{c}} \quad (\text{NDS Eqn. 3.7 – 1})$$

Where:

$$F_c^* = F_c \times C_D = 1850 \times 0.9 = 1665 \text{ psi}$$

$$F_{cE} = \frac{0.822 \times E'_{min}}{(l_e/d)^2} = \frac{0.822 \times 620000}{(52/3.5)^2} = 2308.8 \text{ psi}$$

$$\text{Length of Span} = l_u = 52 \text{ in}$$

$$l_e = l_u \times K_e = 52 \text{ in} \times 1.0 \quad (\text{Pin – Pin: } K_e = 1.0)$$

$$c = 0.8 \quad (\text{For Sawn Lumber})$$

(Insert the Above Values into NDS Eqn. 3.7 – 1)

$$C_P = 0.79$$

From Equation 3:  $F'_c = F_c \times C_P \times 2.16/\phi \times \phi \times 0.6$

$$F'_c = 1850 \times 0.79 \times 2.16/\phi \times \phi \times 0.6$$

$$F'_c = 1894.1 \text{ psi}$$

$$\mathbf{R_c = F'_c \times A_g} \quad \mathbf{Eq. 4}$$

Where:  $R_c$ : Design Compression Force Parallel to Grain (per post)  
 $F'_c$ : Adjusted Design Compression Stress Parallel to Grain  
 $A_g$ : Gross Cross – Sectional Area

From Equation 4:  $R_c = F'_c \times A_g = 1894.1\text{psi} \times 3.5\text{in} \times 3.5\text{in} = 23202.8\text{ lbs}$   
 $R_c = 23.2\text{ kips/post} \times 4\text{ posts}$   
Total Capacity = 92.8 kips

#### A5. 2x4 Brace Connection Design Calculations (3 Nails): Single Shear

$$\mathbf{Z'} = \mathbf{Z} \times \mathbf{K}_F \times \boldsymbol{\phi}_z \times \boldsymbol{\lambda} \quad \text{Eq. 5}$$

Where:  $Z'$ : Adjusted Shear Yield Value per Nail  
 $Z$ : Reference Shear Yield Value  
 $K_F$ : LRFD Format Conversion Factor  
 $\phi_z$ : Resistance Factor  
 $\lambda$ : Time Effect Factor = 0.6 (Conservative)

(Note: All 'C' Adjustment Factors for Nails and Experimental Conditions = 1.0)

6 Possible Yield Modes:  $Z_{Im} = \frac{D \times l_m \times F_{em}}{R_d}$  (NDS Eqn 11.3 – 1)

$$Z_{Is} = \frac{D \times l_s \times F_{es}}{R_d} \quad \text{(NDS Eqn 11.3 – 2)}$$

$$Z_{II} = \frac{k_1 \times D \times l_s \times F_{es}}{R_d} \quad \text{(NDS Eqn 11.3 – 3)}$$

$$Z_{III m} = \frac{k_2 \times D \times l_m \times F_{em}}{(1 + 2R_e)R_d} \quad \text{(NDS Eqn 11.3 – 4)}$$

$$Z_{III s} = \frac{k_3 \times D \times l_s \times F_{em}}{(1 + 2R_e)R_d} \quad \text{(NDS Eqn 11.3 – 5)}$$

$$Z_{IV} = \frac{D^2}{R_d} \sqrt{\frac{2F_{em} \times F_{yb}}{3(1 + R_e)}} \quad (\text{NDS Eqn 11.3 - 6})$$

Where:  $k_1 = \frac{\sqrt{R_e + 2R_e^2(1 + R_t + R_t^2) + R_t^2R_e^3} - R_e(1 + R_t)}{(1 + R_e)}$

$$k_2 = -1 + \sqrt{2(1 + R_e) + \frac{2F_{yb}(1 + 2R_e)D^2}{3F_{em}l_m^2}}$$

$$k_3 = -1 + \sqrt{\frac{2(1 + R_e)}{R_e} + \frac{2F_{yb}(2 + R_e)D^2}{3F_{em}l_s^2}}$$

$D$ : Diameter of Fastener, in

$F_{yb}$ : Dowel Bending Yield Strength, psi (Tbl I1)

$R_d$ : Reduction Term (Tbl 11.3.1B)

$R_e = F_{em}/F_{es}$

$R_t = l_m/l_s$

$l_m$ : Main Member Dowel Bearing Length, in

$l_s$ : Side Member Dowel Bearing Length, in

$F_{em}$ : Main Member Dowel Bearing Strength, psi (Tbl 11.3.2)

$F_{es}$ : Side Member Dowel Bearing Strength, psi (Tbl 11.3.2)

Where:  $D = 0.148$  in

$F_{yb} = 90000$ psi

$R_d = 2.2$

Specific Gravity SYP:  $G = 0.55$  (NDS Tbl 11.3.2A)

For a Nail in SYP ( $G = 0.55$ ) with  $D = 0.148 < 0.25$ in:

$$F_{em} = F_{es} = 5550 \text{psi} \quad (\text{NDS Section 11.3.2})$$

$$R_e = 1.0$$

3.25in Long Nail through 2x4 ( $t = 1.5\text{in}$ ) into 4x4 Post:

$$l_s = 1.5 \text{ in}$$

$$l_m = 3.25\text{in} - 1.5 \text{ in} = 1.75\text{in}$$

$$R_t = 1.75/1.5 = 1.17$$

Using the Above Values:

$$k_1 = 0.45$$

$$k_2 = 1.06$$

$$k_3 = 1.08$$

$$Z_{Im} = 653.4 \text{ lbs/nail}$$

$$Z_{Is} = 560.0 \text{ lbs/nail}$$

$$Z_{II} = 252.6 \text{ lbs/nail}$$

$$Z_{III m} = 230.2 \text{ lbs/nail}$$

$$Z_{III s} = 201.1 \text{ lbs/nail}$$

$$Z_{IV} = 128.5 \text{ lbs/nail} \quad (\text{Controls})$$

From Equation 5:  $Z' = Z \times K_F \times \phi_z \times \lambda = 128.5 \times 2.16/\phi \times \phi \times 0.6$

$$Z' = 166.5 \text{ lbs/nail}$$

$$Z' = 166.5 \text{ lbs/nail} \times 3 \text{ nails} = 499.6 \text{ lbs}$$

Total Capacity = 0.50 kips

#### A6. 2x4 Brace Connection Design Calculations (3 Nails): Withdrawal

$$W' = W \times K_F \times \phi_z \times \lambda \quad \text{Eq. 6}$$

Where:  $W'$ : Adjusted Withdrawal Value per Nail

*W*: Reference Withdrawal Value per Inch of Penetration

*K<sub>F</sub>*: LRFD Format Conversion Factor

*φ<sub>z</sub>*: Resistance Factor

*λ*: Time Effect Factor = 0.6 (Conservative)

(Note: All 'C' Adjustment Factors for Nails and Experimental Conditions = 1.0)

$$\text{Specific Gravity SYP} = G = 0.55 \quad (\text{NDS Tbl 11.3.2A})$$

$$w \text{ (for 0.148 Dia. nail)} = 46\text{lbs/in} \quad (\text{NDS Tbl 11.2C})$$

$$W = 46\text{lbs/in} \times 1.75\text{in penetration} = 80.5\text{lbs}$$

From Equation 6:  $W' = W \times K_F \times \phi_z \times \lambda = 80.5 \times 2.16/\phi \times \phi \times 0.6$

$$W' = 104.3 \text{ lbs/nail}$$

$$W' = 104.3 \text{ lbs/nail} \times 3 \text{ nails} = 313.0 \text{ lbs}$$

$$\underline{\text{Total Capacity} = 0.31 \text{ kips}}$$

#### **A7. Plywood Brace Connection Design Calculations (14 Nails): Single Shear**

$$Z' = Z \times K_F \times \phi_z \times \lambda \quad \text{Eq. 5}$$

Where: *Z'*: Adjusted Shear Yield Value per Nail

*Z*: Reference Shear Yield Value

*K<sub>F</sub>*: LRFD Format Conversion Factor

*φ<sub>z</sub>*: Resistance Factor

*λ*: Time Effect Factor = 0.6 (Conservative)

(Note: All 'C' Adjustment Factors for Nails and Experimental Conditions = 1.0)

6 Possible Yield Modes:  $Z_{Im} = \frac{D \times l_m \times F_{em}}{R_d} \quad (\text{NDS Eqn 11.3 - 1})$

$$Z_{Is} = \frac{D \times l_s \times F_{es}}{R_d} \quad (\text{NDS Eqn 11.3 - 2})$$

$$Z_{II} = \frac{k_1 \times D \times l_s \times F_{es}}{R_d} \quad (\text{NDS Eqn 11.3 - 3})$$

$$Z_{III m} = \frac{k_2 \times D \times l_m \times F_{em}}{(1 + 2R_e)R_d} \quad (\text{NDS Eqn 11.3 - 4})$$

$$Z_{III s} = \frac{k_3 \times D \times l_s \times F_{em}}{(1 + 2R_e)R_d} \quad (\text{NDS Eqn 11.3 - 5})$$

$$Z_{IV} = \frac{D^2}{R_d} \sqrt{\frac{2F_{em} \times F_{yb}}{3(1 + R_e)}} \quad (\text{NDS Eqn 11.3 - 6})$$

Where:  $D = 0.131 \text{ in}$

$F_{yb} = 100,000 \text{ psi}$

$R_d = 2.2$

Specific Gravity SYP:  $G = 0.55$  (NDS Tbl 11.3.2A)

Specific Gravity Plywood:  $G = 0.42$  (NDS Tbl 11.3.2A)

For a Nail in SYP and Plywood with  $D = 0.131 < 0.25 \text{ in}$ :

$F_{em} = 5550 \text{ psi}$  (NDS Section 11.3.2)

$F_{em} = 3350 \text{ psi}$  (NDS Section 11.3.2B)

$R_e = 1.66$

2.5in Long Nail through 5/8in Plywood into 4x4 Post:

$l_s = 0.625 \text{ in}$

$l_m = 2.5 \text{ in} - 0.625 \text{ in} = 1.875 \text{ in}$

$R_t = 1.875 / 1.5 = 1.25$

Using the Above Values:

$k_1 = 1.52$

$$k_2 = 1.36$$

$$k_3 = 1.27$$

$$Z_{Im} = 619.6 \text{ lbs/nail}$$

$$Z_{Is} = 124.7 \text{ lbs/nail}$$

$$Z_{II} = 189.9 \text{ lbs/nail}$$

$$Z_{III_m} = 195.3 \text{ lbs/nail}$$

$$Z_{III_s} = 71.5 \text{ lbs/nail} \quad (\text{Controls})$$

$$Z_{IV} = 92.1 \text{ lbs/nail}$$

From Equation 5:  $Z' = Z \times K_F \times \phi_z \times \lambda = 71.5 \times 2.16 / \phi \times \phi \times 0.6$

$$Z' = 92.6 \text{ lbs/nail}$$

$$Z' = 64.4 \text{ lbs/nail} \times 14 \text{ nails} = 1296.4 \text{ lbs}$$

$$\underline{\text{Total Capacity} = 1.30 \text{ kips}}$$

#### A8. Plywood Brace Connection Design Calculations (14 Nails): Withdrawal

$$W' = W \times K_F \times \phi_z \times \lambda \quad \text{Eq. 6}$$

Where:  $W'$ : Adjusted Withdrawal Value per Nail

$W$ : Reference Withdrawal Value per Inch of Penetration

$K_F$ : LRFD Format Conversion Factor

$\phi_z$ : Resistance Factor

$\lambda$ : Time Effect Factor = 0.6 (Conservative)

(Note: All 'C' Adjustment Factors for Nails and Experimental Conditions = 1.0)

$$\text{Specific Gravity SYP} = G = 0.55 \quad (\text{NDS Tbl 11.3.2A})$$

$$w \text{ (for 0.131 Dia. nail)} = 41 \text{ lbs/in} \quad (\text{NDS Tbl 11.2C})$$

$$W = 41\text{lbs/in} \times 1.875\text{in penetration} = 76.9\text{lbs}$$

From Equation 6:  $W' = W \times K_F \times \phi_z \times \lambda = 76.9 \times 2.16/\phi \times \phi \times 0.6$

$$W' = 99.7 \text{ lbs/nail}$$

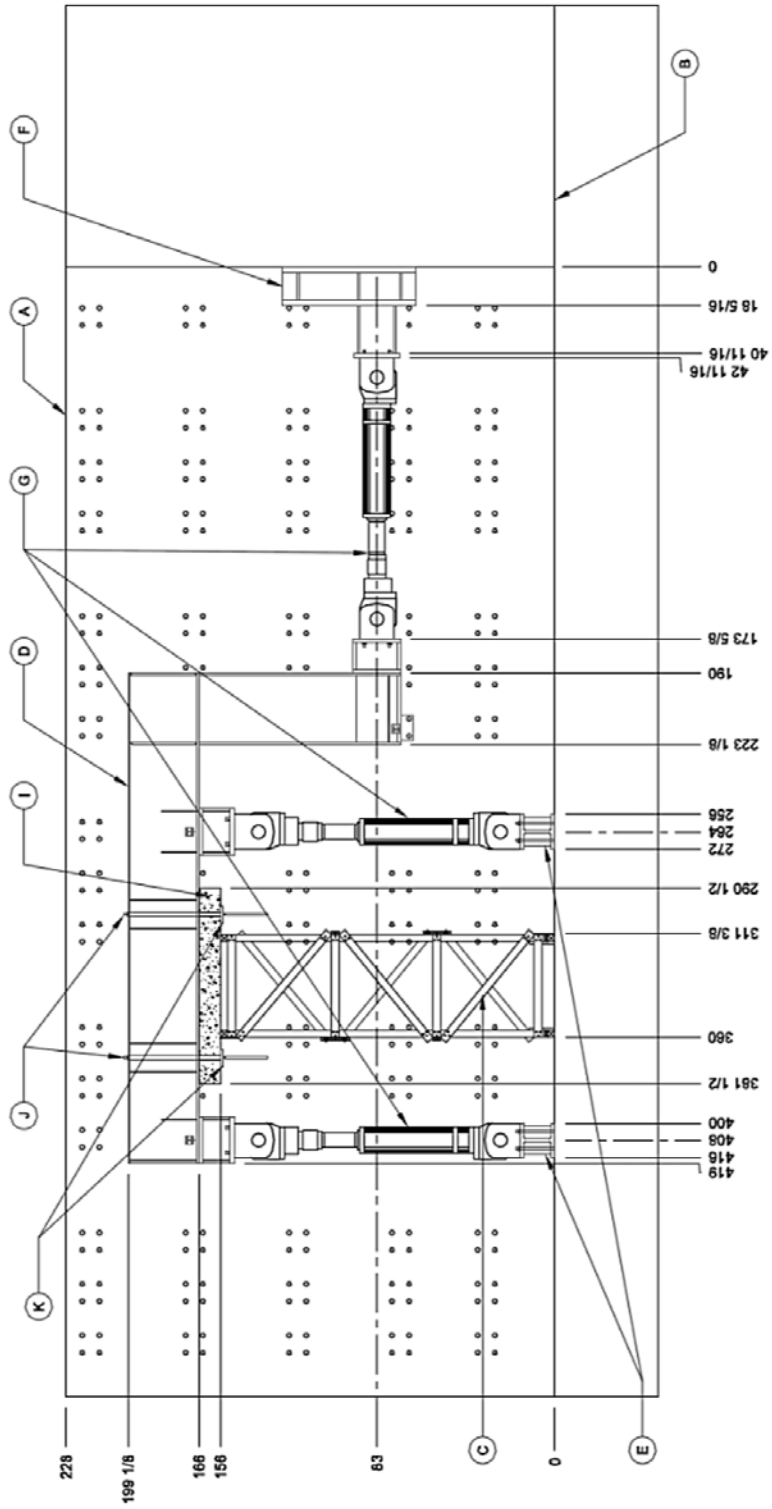
$$W' = 99.7 \text{ lbs/nail} \times 14 \text{ nails} = 1395.3 \text{ lbs}$$

$$\underline{\text{Total Capacity} = 1.40 \text{ kips}}$$

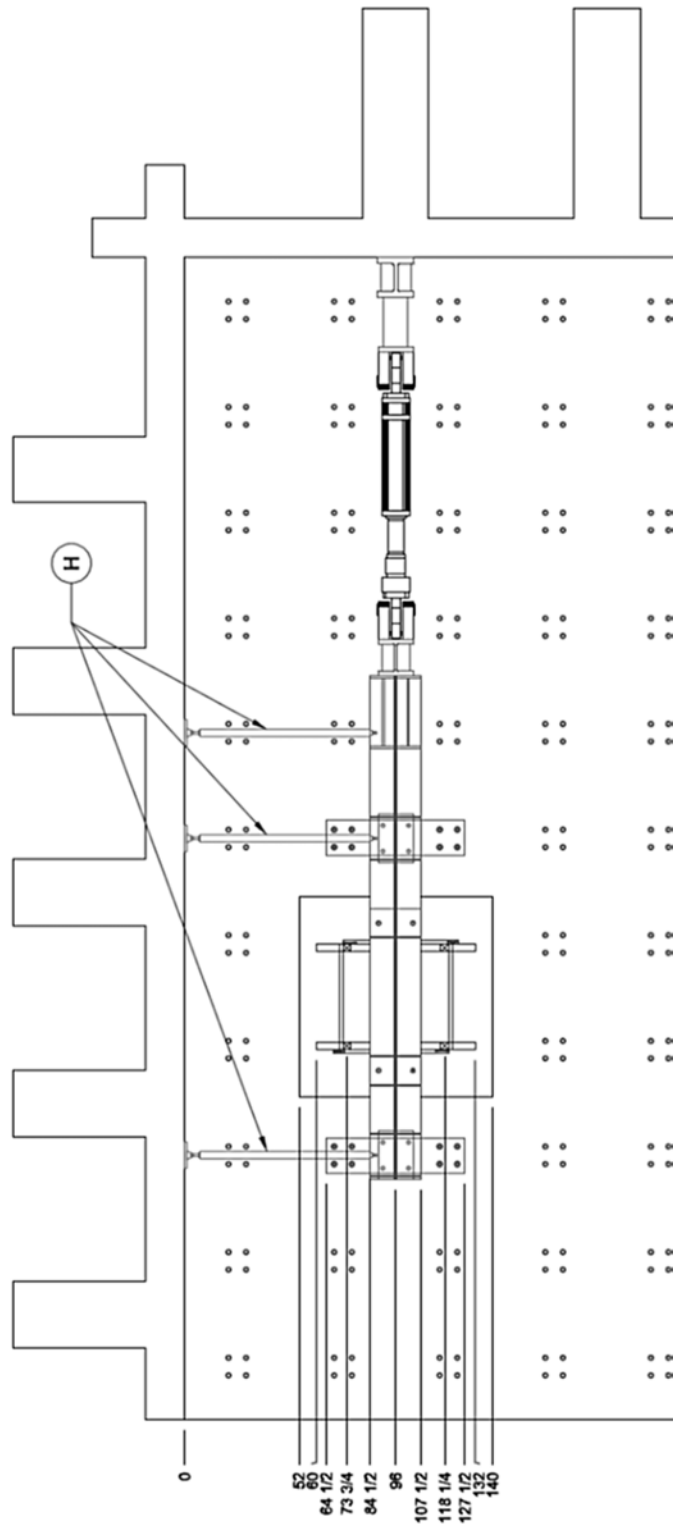


**APPENDIX B**  
**Loading Frame Details**

ITEM	DESCRIPTION	QTY
A	REACTION WALL	1
B	STRONG FLOOR	1
C	LACED POST SHORE	1
D	L-FRAME	1
E	FLOOR SPREADER BEAM	2
F	WALL SPREADER BEAM	1
G	MIS ACTUATOR	3
H	LATERAL BRACING	3
I	CONCRETE HEADER	1
J	B7 RODS $\phi$ 1.25x165"	4
K	BEARING PLATE	4



**Figure B.1** Front Elevation View of Test Setup



**Figure B.2** Plan View of Test Setup

## References

- American Forest & Paper Association; American Wood Council. (2005). *National Design Specifications for Wood Construction*.
- Bodig, J., & Jayne, B. (1982). *Mechanics of Wood and Wood Composites*. New York: Van Nostrand Reinhold.
- Breyer, D. E., Fridley, K. J., Cobeen, K. E., & Pollock, D. G. (2007). *Design of Wood Structures ASD/LRFD 6th Edition*. 2007: Mcgraw-Hill.
- FEMA StS2 Summary- Testing of Laced Post & Plywood Laced Posts*. (2011, February). Retrieved February 3, 2012, from DisasterEngineer.org: FEMA US&R Structures Sub-Group Resource: <http://www.disasterengineer.org>
- Forest Products Laboratory, USDA. (1951). *Relation of Strength of Wood to Duration of Load, Report #1916*.
- Forest Products Laboratory, USDA Forest Service. (2010). *Wood Handbook*. Madison: Forest Products Laboratory.
- Goodman, J. R., & Bodig, J. (1970). Orthotropic Elastic Properties of Wood. *Journal of the Structural Division: Proceedings of the American Society of Civil Engineers*, 2301-2317.
- Hammond, D. J. (2011, September 1). *Wood Shoring Systems: How Do They Perform?* Retrieved February 3, 2012, from FireEngineering.com: <http://www.fireengineering.com>
- O'Connell, J. P. (2006). *Emergency Rescue Shoring Techniques*. Tulsa: PennWell.
- Structural Collapse Technician Course - Student Manual*. (2010, August 11). Retrieved February 3, 2012, from FEMA.gov: <http://www.fema.gov/emergency/usr/sctc.shtm>
- US Army Corps of Engineers. (February 2009). *US&R Structures Specialist Field Operations Guide (FOG)* (6th ed.).
- US Army Corps of Engineers. (July 2011). *US&R Structures Specialist Field Operations Guide (FOG)*.