

Copyright  
by  
Miguel Forero Henao  
2010

**The Thesis Committee for Miguel Forero Henao  
certifies that this is the approved version of the following thesis:**

**Autoclaved Aerated Concrete (AAC) Masonry: Lap-Splice Provisions  
and Nominal Capacity for Interface Shear Transfer between  
Grout and AAC**

**APPROVED BY  
SUPERVISING COMMITTEE:**

---

Richard E. Klingner, Supervisor

---

Wassim M. Ghannoum

**Autoclaved Aerated Concrete (AAC) Masonry: Lap-Splice Provisions  
and Nominal Capacity for Interface Shear Transfer between  
Grout and AAC**

**by**

**Miguel Forero Henao, C.E.**

**Thesis**

Presented to the Faculty of the Graduate School of

The University of Texas at Austin

in Partial Fulfillment

of the Requirements

for the Degree of

**Master of Science in Engineering**

**The University of Texas at Austin**

**December 2010**

## **Dedication**

To my wife Olga Lucía

## **Acknowledgements**

The testing programs described in this thesis were conducted in the Phil M. Ferguson Structural Engineering Laboratory of The University of Texas at Austin. Its staff deserves the credit for making it possible through their work and dedication. To my fellow graduate students, I am grateful for making up for my lack of “laboratory experience” and for their help in grouting the test specimens. I thank Shiv S. Ravichandran and Mónica Puglisi Villamediana for their role in the preliminary design of the testing programs.

I appreciate the Autoclaved Aerated Concrete Products Association (AACPA) for sponsoring the testing programs, especially Emilio Carranza Guillen with Xella Mexicana for his commitment. I thank Salvador Ochoa and his crew for teaching me how to lay autoclaved aerated concrete (AAC) masonry units using thin-bed mortar, and for their assistance in constructing the walls that were used in the lap-splice specimens.

I express my sincere gratitude to Dr. Richard E. Klingner for giving me the opportunity to work with him on the ongoing research on AAC. From this learning experience, I move on with professional and personal skills that are invaluable. His dedication and hard work are greatly appreciated. I am thankful to Dr. Wassim M. Ghannoum for reviewing this thesis.

I express my sincere appreciation to Asit N. Baxi with Suncoast Post-Tension, Ltd., for his support. Working with him has made me a better engineer.

I am grateful to my family, especially to my wife for her unconditional support, and to my parents for their encouragement.

August 24, 2010

## **Abstract**

# **Autoclaved Aerated Concrete (AAC) Masonry: Lap-Splice Provisions and Nominal Capacity for Interface Shear Transfer between Grout and AAC**

Miguel Forero Henao, M.S.E.

The University of Texas at Austin, 2010

Supervisor: Richard E. Klingner

Design of autoclaved aerated concrete (AAC) masonry in the United States is currently based on Appendix A of the 2008 Masonry Standards Joint Committee (MSJC) *Code*. Those provisions include the design of lap splices, and equations for the nominal capacity in interface shear transfer between grout and AAC. The provisions for lap splices are an extension of the provisions for concrete or clay masonry, modified to neglect the contribution of AAC to splice capacity. This thesis describes a testing program aimed at verifying the current provisions using tests of lap splices in grouted AAC masonry. Based on the results of those tests, the provisions are shown to be appropriate. The provisions on interface shear transfer between grout and AAC require that the transferred shear be checked against a nominal capacity based on limited test results. This thesis describes a testing program aimed at verifying and refining this nominal capacity using pullout tests of grout cores in AAC masonry units. Based on the results of those tests, the currently used nominal capacity is shown to be conservative, and a recommendation is made to increase it.

## Table of Contents

|   |    |
|---|----|
| CHAPTER 1 Introduction, Objectives, and Scope.....                  | 1  |
| 1.1 INTRODUCTION .....  | 1  |
| 1.2 OBJECTIVES .....  | 1  |
| 1.3 SCOPE .....   | 2  |
| CHAPTER 2 Code Requirements and Background .....                    | 3  |
| 2.1 Introduction.....   | 3  |
| 2.2 2008 MSJC Code Requirements for Lap Splices in AAC Masonry..... | 3  |
| 2.3 Background on Requirements for Lap Splices in AAC Masonry.....  | 3  |
| 2.4 2008 MSJC Code Requirements for Interface Shear Strength .....  | 4  |
| 2.5 Background on Requirements for Interface Shear Strength .....   | 5  |
| CHAPTER 3 Testing of Lap Splices .....                              | 6  |
| 3.1 Introduction.....   | 6  |
| 3.2 Lap-splice Specimens .....                                      | 6  |
| 3.3 Predicted Strength of the Lap-splice Specimens .....            | 9  |
| 3.4 Construction of Lap-Splice Specimens.....                       | 10 |
| 3.5 Material Testing, Lap-Splice Specimens .....                    | 18 |
| 3.6 Summary of Material Test Results, Lap-Splice Specimens.....     | 19 |
| 3.7 Lap-Splice Test Setup.....                                      | 21 |
| 3.8 Instrumentation of Lap-Splice Specimens .....                   | 23 |
| 3.9 Testing Procedure for Lap-Splice Tests.....                     | 25 |
| 3.10 Summary of the Splice-Test Results.....                        | 26 |
| 3.11 Significance of the Splice-Test Results .....                  | 33 |
| CHAPTER 4 Testing of Interface Shear Transfer .....                 | 35 |
| 4.1 Introduction.....   | 35 |
| 4.2 Pullout Specimens.....  | 35 |
| 4.3 Predicted Strength of the Pullout Specimens .....               | 36 |
| 4.4 Construction of the Pullout Specimens.....                      | 38 |

|            |   |    |
|------------|---|----|
| 4.5        | Material Testing, Pullout Specimens .....                           | 41 |
| 4.6        | Summary of Material Test Results, Pullout Specimens.....            | 42 |
| 4.7        | Pullout Test Setup.....   | 43 |
| 4.8        | Instrumentation of Pullout Specimens .....                          | 44 |
| 4.9        | Testing Procedure for Pullout Tests.....                            | 45 |
| 4.10       | Summary of the Pullout-Test Results .....                           | 46 |
| 4.11       | Significance of Pullout-Test Results.....                           | 52 |
| CHAPTER 5  | Summary, Conclusions, and Recommendations .....                     | 56 |
| 5.1        | Summary.....  | 56 |
| 5.2        | Conclusions.....  | 57 |
| 5.3        | Recommendations for Future Work.....                                | 58 |
| 5.3.1      | Future Work related to Splices in Masonry in General .....          | 58 |
| 5.3.2      | Future Work related to the Scope of this Thesis .....               | 58 |
| APPENDIX A | Lap-Splice Test: Photos and Load-Displacement Responses .....       | 59 |
| A.1        | Introduction.....   | 59 |
| A.2        | Photographic Record.....  | 59 |
| A.3        | Load-Displacement Responses .....                                   | 65 |
| APPENDIX B | Pullout Test: Photos and Load-Displacement Responses .....          | 75 |
| B.1        | Introduction.....   | 75 |
| B.2        | Photographic Record.....  | 75 |
| B.3        | Load-Displacement Responses .....                                   | 78 |
| APPENDIX C | Material Test Results.....  | 81 |
| C.1        | Introduction.....   | 81 |
| C.2        | Grout: Slump and Dimensions of Prisms.....                          | 81 |
| C.3        | Reinforcing Steel: Stress-Strain Curves and Mill Certificates ..... | 85 |
| REFERENCES | .....   | 90 |
| VITA       | .....   | 93 |



## List of Tables

|   |    |
|---|----|
| Table 3.1 Required splice length for each bar size (2008 MSJC Code) .....               | 9  |
| Table 3.2 Strength of the splice specimens predicted by the 2008 MSJC Code .....        | 10 |
| Table 3.3 Compressive strength of grout in lap-splice specimens with No. 3 bars .....   | 19 |
| Table 3.4 Compressive strength of grout in lap-splice specimens with No. 4 bars .....   | 20 |
| Table 3.5 Compressive strength of grout used in lap-splice specimens with No. 5 bars..  | 20 |
| Table 3.6 Summary of test results for reinforcing bars in lap-splice specimens .....    | 21 |
| Table 3.7 Summary of test results – Splice specimens with No. 3 bars .....              | 27 |
| Table 3.8 Summary of test results – Splice specimens with No. 4 bars .....              | 27 |
| Table 3.9 Summary of test results – Splice specimens with No. 5 bars .....              | 28 |
| Table 4.1 Summary of expected strengths – Pullout specimens.....                        | 36 |
| Table 4.2 Required development length – Pullout specimen .....                          | 37 |
| Table 4.3 Expected strength – Governed by bar-yield, bar-grout bond, or grout splitting | 38 |
| Table 4.4 Compressive strength of grout in pullout specimens.....                       | 43 |
| Table 4.5 Summary of pullout test results .....   | 47 |
| Table 4.6 Parameters – Development length in 3-in. and 4-in. cores.....                 | 54 |
| Table C.1 Slump – Grout .....   | 81 |
| Table C.2 Fabrication date and testing age – Grout Prisms.....                          | 82 |
| Table C.3 Prism height – Grout used in pullout specimens.....                           | 82 |
| Table C.4 Prism width – Grout used in pullout specimens.....                            | 82 |
| Table C.5 Prism height – Grout used in lap-splice specimens (No. 3 bars) .....          | 83 |
| Table C.6 Prism width – Grout used in lap-splice specimens (No. 3 bars) .....           | 83 |
| Table C.7 Prism height – Grout used in lap-splice specimens (No. 4 bars) .....          | 83 |
| Table C.8 Prism width – Grout used in lap-splice specimens (No. 4 bars) .....           | 84 |
| Table C.9 Prism height – Grout used in lap-splice specimens (No. 5 bars) .....          | 84 |
| Table C.10 Prism width – Grout used in lap-splice specimens (No. 5 bars) .....          | 84 |

## List of Figures

|  |    |
|--|----|
| Figure 3.1 Lap-splice specimen – No. 3 bars.....                                       | 7  |
| Figure 3.2 Lap-splice specimen – No. 4 bars.....                                       | 7  |
| Figure 3.3 Lap-splice specimen – No. 5 bars.....                                       | 8  |
| Figure 3.4 Construction of lap-splice specimens – No. 3 bars.....                      | 11 |
| Figure 3.5 Construction of lap-splice specimens – No. 4 bars .....                     | 11 |
| Figure 3.6 Construction of lap-splice specimens – No. 5 bars .....                     | 12 |
| Figure 3.7 Core drilling of blocks in lap-splice specimens .....                       | 12 |
| Figure 3.8 Construction of base-walls .....  | 13 |
| Figure 3.9 Bars spliced inside a core – No. 3 bars (left) and No. 4 bars (right) ..... | 14 |
| Figure 3.10 Cleanouts in a lap-splice specimen with No. 5 bars.....                    | 14 |
| Figure 3.11 Splice specimens prior to grouting – No. 5 bars .....                      | 15 |
| Figure 3.12 Cement, sand, and pea gravel used to grout the specimens with No. 4 bars . | 16 |
| Figure 3.13 Mixing of the grout used in the splice specimens with No. 5 bars.....      | 16 |
| Figure 3.14 Initial slump test – Grout used in splice specimens with No. 5 bars.....   | 17 |
| Figure 3.15 Grouting of lap-splice specimens with No. 5 bars .....                     | 18 |
| Figure 3.16 Fabrication of grout prisms .....  | 19 |
| Figure 3.17 Lap-splice test setup .....  | 22 |
| Figure 3.18 Rams and pressure gauge connected to air-driven hydraulic pump.....        | 22 |
| Figure 3.19 Lap-splice specimen on rollers prior to testing .....                      | 23 |
| Figure 3.20 Instrumentation – lap-splice test.....                                     | 24 |
| Figure 3.21 Instrumentation – top end of specimen .....                                | 25 |
| Figure 3.22 Instrumentation – bottom end of specimen .....                             | 25 |
| Figure 3.23 Specimen N3S6 – Left and right splices .....                               | 28 |
| Figure 3.24 Specimen N4S4 – Left and right splices .....                               | 29 |
| Figure 3.25 Specimen N5S4 – Left and right splices .....                               | 29 |
| Figure 3.26 Left splice N3S1 (left) & left splice N3S5 (right).....                    | 30 |
| Figure 3.27 Left splice N4S2 (left) & right splice N4S3 (right).....                   | 30 |

|  |    |
|--|----|
| Figure 3.28 Right splice N5S1 (left) & right splice N5S3 (right) .....             | 31 |
| Figure 3.29 Void in grout surrounding the right splice of Specimen N3S4 .....      | 31 |
| Figure 3.30 Load-displacement response – Specimen N3S6.....                        | 32 |
| Figure 3.31 Load-displacement response – Specimen N4S4.....                        | 33 |
| Figure 3.32 Load-displacement response – Specimen N5S4.....                        | 33 |
| Figure 4.1 Pullout specimen .....  | 36 |
| Figure 4.2 Core drilling of holes in specimens (repeated from Chapter 3) .....     | 39 |
| Figure 4.3 Pullout specimens prior to grouting .....                               | 39 |
| Figure 4.4 Mixer used to produce the grout.....                                    | 40 |
| Figure 4.5 Pullout specimens after grouting.....                                   | 41 |
| Figure 4.6 Fabrication of grout prisms .....                                       | 42 |
| Figure 4.7 Photograph of pullout test setup .....                                  | 44 |
| Figure 4.8 Instrumentation – pullout tests .....                                   | 45 |
| Figure 4.9 Histogram and probability density of the pullout test results.....      | 48 |
| Figure 4.10 Specimens AS2 (left) and AS3 (right).....                              | 49 |
| Figure 4.11 Specimens AS15 (left) and AS18 (right).....                            | 49 |
| Figure 4.12 Blocks – AS1 through AS9 (right) & AS10 through AS18 (left) .....      | 50 |
| Figure 4.13 Grout cores – AS1 through AS9 (top) & AS10 through AS18 (bottom) ..... | 50 |
| Figure 4.14 Load-displacement response – Specimens AS2, AS3, AS15 and AS18.....    | 52 |
| Figure 4.15 Length ratio for reinforcing bars in 3-in. cores .....                 | 54 |
| Figure 4.16 Length ratio for reinforcing bars in 3-in. cores .....                 | 55 |
| Figure A.1 Specimen N3S1 – Left and right splices .....                            | 59 |
| Figure A.2 Specimen N3S2 – Left and right splices .....                            | 59 |
| Figure A.3 Specimen N3S3 – Left and right splices .....                            | 60 |
| Figure A.4 Specimen N3S4 – Left and right splices .....                            | 60 |
| Figure A.5 Specimen N3S5 – Left and right splices .....                            | 60 |
| Figure A.6 Specimen N3S6 – Left and right splices .....                            | 61 |
| Figure A.7 Specimen N4S1 – Left and right splices .....                            | 61 |
| Figure A.8 Specimen N4S2 – Left and right splices .....                            | 61 |

|   |    |
|---|----|
| Figure A.9 Specimen N4S3 – Left and right splices .....     | 62 |
| Figure A.10 Specimen N4S4 – Left and right splices .....    | 62 |
| Figure A.11 Specimen N4S5 – Left and right splices .....    | 62 |
| Figure A.12 Specimen N4S6 – Left and right splices .....    | 63 |
| Figure A.13 Specimen N5S1 – Left and right splices .....    | 63 |
| Figure A.14 Specimen N5S2 – Left and right splices .....    | 63 |
| Figure A.15 Specimen N5S3 – Left and right splices .....    | 64 |
| Figure A.16 Specimen N5S4 – Left and right splices .....    | 64 |
| Figure A.17 Specimen N5S5 – Left and right splices .....    | 64 |
| Figure A.18 Specimen N5S6 – Left and right splices .....    | 65 |
| Figure A.19 Load-displacement response – Specimen N3S1..... | 65 |
| Figure A.20 Load-displacement response – Specimen N3S2..... | 66 |
| Figure A.21 Load-displacement response – Specimen N3S3..... | 66 |
| Figure A.22 Load-displacement response – Specimen N3S4..... | 67 |
| Figure A.23 Load-displacement response – Specimen N3S5..... | 67 |
| Figure A.24 Load-displacement response – Specimen N3S6..... | 68 |
| Figure A.25 Load-displacement response – Specimen N4S1..... | 68 |
| Figure A.26 Load-displacement response – Specimen N4S2..... | 69 |
| Figure A.27 Load-displacement response – Specimen N4S3..... | 69 |
| Figure A.28 Load-displacement response – Specimen N4S4..... | 70 |
| Figure A.29 Load-displacement response – Specimen N4S5..... | 70 |
| Figure A.30 Load-displacement response – Specimen N4S6..... | 71 |
| Figure A.31 Load-displacement response – Specimen N5S1..... | 71 |
| Figure A.32 Load-displacement response – Specimen N5S2..... | 72 |
| Figure A.33 Load-displacement response – Specimen N5S3..... | 72 |
| Figure A.34 Load-displacement response – Specimen N5S4..... | 73 |
| Figure A.35 Load-displacement response – Specimen N5S5..... | 73 |
| Figure A.36 Load-displacement response – Specimen N5S6..... | 74 |
| Figure B.1 Specimens AS1 (left) and AS2 (right).....        | 75 |

|   |    |
|---|----|
| Figure B.2 Specimens AS3 (left) and AS4 (right).....                      | 75 |
| Figure B.3 Specimens AS5 (left) and AS6 (right).....                      | 76 |
| Figure B.4 Specimens AS7 (left) and AS8 (right).....                      | 76 |
| Figure B.5 Specimens AS9 (left) and AS10 (right).....                     | 76 |
| Figure B.6 Specimens AS11 (left) and AS12 (right).....                    | 77 |
| Figure B.7 Specimens AS13 (left) and AS14 (right).....                    | 77 |
| Figure B.8 Specimens AS15 (left) and AS16 (right).....                    | 77 |
| Figure B.9 Specimens AS17 (left) and AS18 (right).....                    | 78 |
| Figure B.10 Load-displacement response – Specimens AS1 through AS4.....   | 78 |
| Figure B.11 Load-displacement response – Specimens AS5 through AS8.....   | 79 |
| Figure B.12 Load-displacement response – Specimens AS9 through AS12.....  | 79 |
| Figure B.13 Load-displacement response – Specimens AS13 through AS16..... | 80 |
| Figure B.14 Load-displacement response – Specimens AS17 and AS18 .....    | 80 |
| Figure C.1 Stress-strain curve – No. 3 bars .....                         | 85 |
| Figure C.2 Stress-strain curve – No. 4 bars .....                         | 85 |
| Figure C.3 Stress-strain curve – No. 5 bars .....                         | 86 |
| Figure C.4 Mill certificate – No. 3 bars.....                             | 87 |
| Figure C.5 Mill certificate – No. 4 bars.....                             | 88 |
| Figure C.6 Mill certificate – No. 5 bars.....                             | 89 |

# CHAPTER 1

## Introduction, Objectives, and Scope

### 1.1 INTRODUCTION

The design of autoclaved aerated concrete (AAC) masonry in the United States is currently based on the design provisions of Appendix A of the 2008 MSJC *Code* (MSJC 2008a). Those provisions include the design of lap splices, and the design capacity for interface shear transfer between grout and AAC.

The provisions for lap splices in AAC masonry are an extension of those for clay and concrete masonry, modified to neglect the contribution of AAC to splice capacity. The latter consider the cover to the exterior masonry surface, and are based on the compressive strength of the masonry assembly, which includes the contribution of the masonry unit, mortar, and grout. For AAC masonry, in contrast, they consider only the cover provided by the grout, and are based on the compressive strength of the grout alone. The contribution of the AAC units is neglected because of their low strength. Even though this assumption seems reasonable, it has not been validated by experiment.

The provisions for interface shear transfer between grout and AAC require that the factored interface shear be checked against a nominal capacity based on limited testing by Tanner (2003), and reduced by the capacity reduction factor for shear. While this nominal capacity is believed to be conservative (low), it would be useful to verify this with additional test data, and to recommend changes to it if warranted.

### 1.2 OBJECTIVES

The objectives of this thesis are:

- To verify the requirements of the 2008 MSJC Code for the design of lap splices in AAC masonry; and
- To verify and refine the nominal capacity specified by the 2008 MSJC *Code* for the interface shear transfer between grout and AAC.

### 1.3 SCOPE

To meet the above objectives, two testing programs were carried out in the Ferguson Structural Engineering Laboratory (FSEL) of the University of Texas at Austin (UT Austin).

In the first program, three sets of six lap-splice specimens each were constructed using 8- x 8- x 24-in. masonry units of Class 4 AAC, joined with thin-bed mortar, and containing lap splices in 4-in. drilled cores. Reduced splice lengths were used to ensure that the strength of the specimens was controlled by splice failure rather than yielding or fracturing of the bars. The bars were intentionally placed off-center in the cores by the maximum placement tolerance permitted by the 2008 MSJC *Specification* (MSJC 2008b). The cores were filled with ASTM C476-09 coarse grout, specified by proportion. The specimens were tested and the measured strength was compared to that predicted by the 2008 MSJC *Code* provisions.

In the second program, one set of 18 pullout specimens was constructed using the same type of units but with 3-in. drilled cores. A reinforcing bar was placed in the center of each core, which was then filled with ASTM C476-09 coarse grout, specified by proportion. The specimens were tested, and the measured pullout strength was used to calculate the nominal interface shear strength between grout and AAC. The results were compared to the current nominal capacity.

In Chapter 2 of this thesis, the provisions in the 2008 MSJC *Code* for the design of lap splices in AAC masonry and for the design of shear transfer between grout and AAC are presented, and their background is reviewed. In Chapters 3 and 4, the testing programs for lap splices and for interface shear transfer are reported, including a description of the test specimens, their construction, the test setups, the instrumentation, and the testing procedures. At the end of these chapters, a summary of the test results is presented and their significance is discussed. In Chapter 5, the testing programs and their results are summarized, along with conclusions and recommendations.

## CHAPTER 2

### Code Requirements and Background

#### 2.1 INTRODUCTION

Appendix A of the 2008 MSJC *Code* (MSJC 2008a) covers the strength design of autoclaved aerated concrete (AAC) masonry. Its provisions address the design of tension lap splices and the shear transfer between grout and AAC. In this chapter, those provisions are presented, and their background is reviewed.

#### 2.2 2008 MSJC CODE REQUIREMENTS FOR LAP SPLICES IN AAC MASONRY

The 2008 MSJC *Code* (MSJC 2008a) requires in Item (a) of Section A.3.3.4 that the minimum length of lap splices be 12 in. or the development length determined by Equation A-6, whichever is greater.

$$l_d = \frac{0.13d_b^2 f_y \gamma}{K_{AAC} \sqrt{f_g'}} \quad \text{MSJC Code Equation A-6}$$

where  $d_b$  is the bar diameter (in.),  $f_y$  is the specified yield strength (psi),  $\gamma$  is a bar size factor, and  $f_g'$  is the specified compressive strength (psi) of grout. For No. 3 through No. 5 bars,  $\gamma$  equals 1.0; for No. 6 through No. 7 bars, 1.3; and for No. 8 through No. 9 bars, 1.5. The factor  $K_{AAC}$  shall not exceed the least of the grout cover, the clear spacing between adjacent reinforcement, or 5 times  $d_b$ .

#### 2.3 BACKGROUND ON REQUIREMENTS FOR LAP SPLICES IN AAC MASONRY

The 2008 MSJC *Code Commentary* (MSJC 2008c) states that the requirements for lap splices in AAC masonry are an extension of those for clay and concrete masonry. The latter consider the minimum clear cover measured to the exterior masonry surface, and are based on the specified compressive strength of the masonry assembly, which



includes the contribution of the masonry unit, mortar, and grout. Compared to grout, AAC has a low compressive strength and tensile strength. Thus in the case of AAC masonry, the cover provided by the AAC unit is ignored in evaluating  $K_{AAC}$ , and the required development length is calculated using the specified compressive strength of grout alone.

The 2008 MSJC *Code Commentary* (MSJC 2008c) also summarizes the rationale behind the required length of lap splices, which is based on the work by the National Concrete Masonry Association (NCMA 1999). Using the results of their own testing program and those of Thompson (1997) and of Hammons *et al.* (1994), the NCMA used the strength of splice specimens that failed due to longitudinal splitting of the masonry to arrive at an expression that best predicted the measured capacities in terms of lap-splice length, diameter of the reinforcement, tested compressive strength of masonry, and clear cover of the reinforcement measured to the closest masonry surface. Consistent with the requirements for mechanical and welded splices, the expression was solved for the lap splice length required to develop a reinforcing steel stress of  $1.25 f_y$ .

That equation was considered not suitable for design practice, and the form of the equation in the *1997 Uniform Building Code* (UBC 1997) was adopted instead. Equation A-6 was arrived at by using that form and calibrating it with all splice specimens that failed due to longitudinal splitting of the masonry. The formula was calibrated so that the mean ratio of the measured strength to the capacity predicted by the formula using the tested masonry compressive strength and the specified yield strength of the reinforcing bars would equal unity.

#### **2.4 2008 MSJC CODE REQUIREMENTS FOR INTERFACE SHEAR STRENGTH**

The 2008 MSJC *Code* (MSJC 2008a) requires that the interface shear transfer between grout and AAC be checked against a nominal capacity of 37 psi, specified in Section A.1.8.4. This nominal capacity is multiplied by the strength-reduction factor,  $\phi$ , to obtain the design strength, where  $\phi$  is equal to 0.80 for the shear capacity of AAC masonry. This design strength should then be equal to or exceed the required strength.

## **2.5 BACKGROUND ON REQUIREMENTS FOR INTERFACE SHEAR STRENGTH**

The 2008 MSJC *Code Commentary* (MSJC 2008c) states that the specified nominal capacity corresponds to the lower 5% fractile of the test results reported by Tanner (2003), and that it is probably a conservative bound based on work by Kingsley *et al.* (1985) for clay or concrete masonry. The three specimens reported by Tanner (2003) consisted of ASTM C476-02 coarse grout poured between two separate blocks of AAC, and tested in direct shear. The results ranged between 49.6 psi and 72.7 psi, with an average of 57.9 psi and a coefficient of variation of 22%.

Kingsley *et al.* (1985) evaluated the interface shear strength between grout and clay units by applying a torsional shear stress to the interface of a grouted core. They report interface shear strengths between 100 and 250 psi for fine grout, and between 180 and 350 psi for coarse grout. They suggest that the interface shear strength of fine grout is slightly less than that of coarse grout because fine grout shrinks more than coarse grout.

## CHAPTER 3

### Testing of Lap Splices

#### 3.1 INTRODUCTION

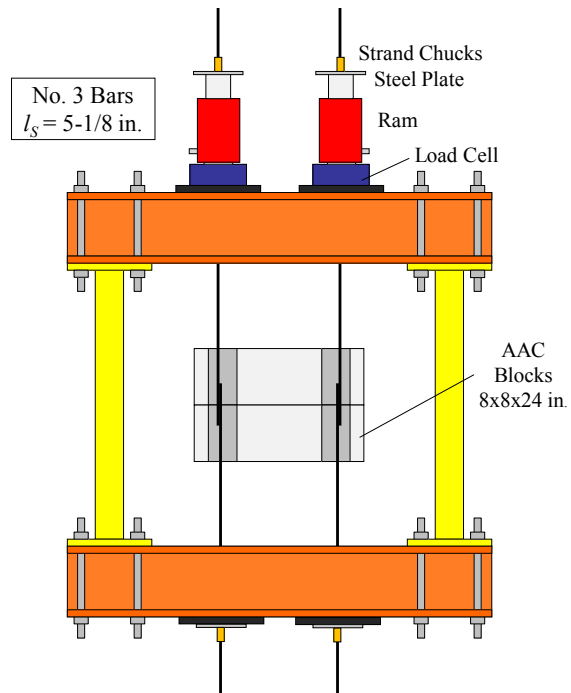
In this chapter, the testing of lap splices is reported, including the following:

- description of the lap-splice specimens;
- predicted strengths of specimens based on the 2008 MSJC *Code*;
- construction of lap-splice specimens;
- material testing and material test results;
- lap-splice test setup and instrumentation;
- testing procedure of lap-splice specimens;
- results of lap-splice tests; and
- significance of lap-splice test results.

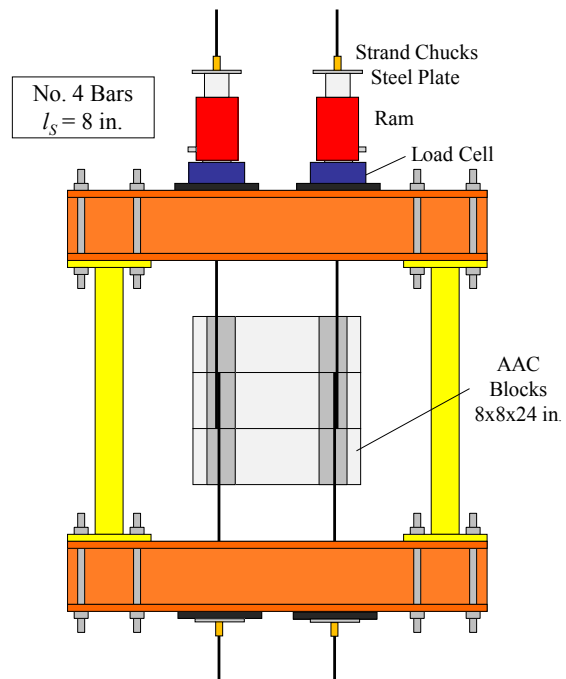
#### 3.2 LAP-SPLICE SPECIMENS

To verify the splice-length requirements of the 2008 MSJC *Code* for AAC masonry, six replicates of the specimens shown in Figure 3.1, Figure 3.2, and Figure 3.3 were constructed and tested. The specimens were made of solid units (8- x 8- x 24-in.) of Class 4 AAC, laid in stack bond using thin-bed mortar. Each specimen had two 4-in. cores, centered 4 in. from the ends of the blocks to maintain modularity with intersecting walls and to conform with typical practice.

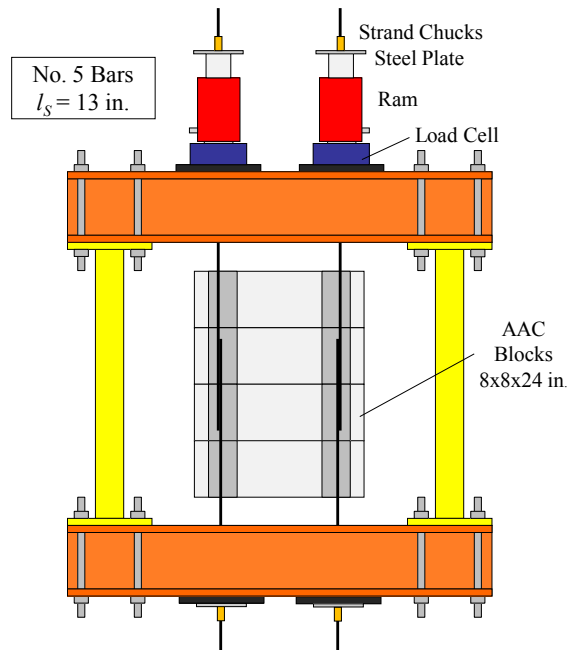
The reinforcing bars were Nos. 3, 4, and 5, conforming to Grade 60 of ASTM A615-09, and lap-spliced at 5-1/8 in., 8 in., and 13 in., respectively. These bar diameters were selected because they are commonly used in reinforced AAC walls. All bars of each diameter were from the same heat. The splice lengths used were reduced from current MSJC requirements to ensure failure of the splice itself, rather than by yield or fracture of the bars. Calculations of those reduced splice lengths and of the expected strengths of the test specimens are presented in Section 3.3.



**Figure 3.1** Lap-splice specimen – No. 3 bars



**Figure 3.2** Lap-splice specimen – No. 4 bars



**Figure 3.3 Lap-splice specimen – No. 5 bars**

Each splice was placed in its core at a radial offset of  $\frac{1}{2}$  in. towards the closest free surface of the AAC block. This offset is the maximum tolerance allowed by the 2008 MSJC *Specification* (MSJC 2008b), and represents the most severe case permitted by that document. Each specimen had two symmetrical splices to eliminate possible effects of the eccentric force couple associated with a single splice. The cores were filled with ASTM C476-09 coarse grout, specified by proportion and consolidated in accordance with the 2008 MSJC *Specification* (MSJC 2008b).

The specimens were tested at least 28 days after fabrication. During the test, the rams were extended, applying tension to the reinforcing bars, splitting forces on the grouted core, shear forces between the bars and the grout, and shear forces at the interface between the grout and the blocks. Possible failure mechanisms were fracturing of the bars, splitting of the grout, bond failure between the bars and the grout, and bond failure between the grout and the AAC.

### 3.3 PREDICTED STRENGTH OF THE LAP-SPLICE SPECIMENS

The design equations of the 2008 MSJC *Code* are calibrated so that the required splice length corresponds to 1.25 times the specified yield strength of the reinforcing bars. On this basis, the required splice length for each set of specimens was calculated using the average compressive strength of the grout reported in Section 3.6 and the specified yield strength (60,000 psi) of the reinforcing bars. These calculations are summarized in Table 3.1.

**Table 3.1 Required splice length for each bar size (2008 MSJC Code)**

| Bar Properties |             | Calculation of $K_{AAC}$ (in.) |             |                            |           | $f_g$ (psi) | $l_d$ (in.) |
|----------------|-------------|--------------------------------|-------------|----------------------------|-----------|-------------|-------------|
| Bar Diameter   | $d_b$ (in.) | $5 d_b$                        | Grout Cover | Clear spacing between bars | $K_{AAC}$ |             |             |
| No. 3          | 0.375       | 1.875                          | 1.8125      | 16                         | 1.8125    | 5,380       | 8.25        |
| No. 4          | 0.500       | 2.500                          | 1.7500      | 16                         | 1.7500    | 5,660       | 14.81       |
| No. 5          | 0.625       | 3.125                          | 1.6875      | 16                         | 1.6875    | 4,930       | 25.72       |

If the full required splice length is provided, the nominal capacity of a splice is intended to equal  $1.25 A_s f_y$ . If a reduced splice length is provided, the expected strength of the splice is equal to that nominal capacity, multiplied by the ratio of the reduced and the required splice lengths. The expected strengths of the test specimens, calculated in this manner, are summarized in Table 3.2, whose notation is defined below:

- $F_y$  = predicted capacity of splice as governed by specified yield of reinforcing bars;
- $F_d$  = predicted capacity of splice as governed by MSJC-required splice length; and
- $F_s$  = predicted capacity of splice as governed by reduced splice length.

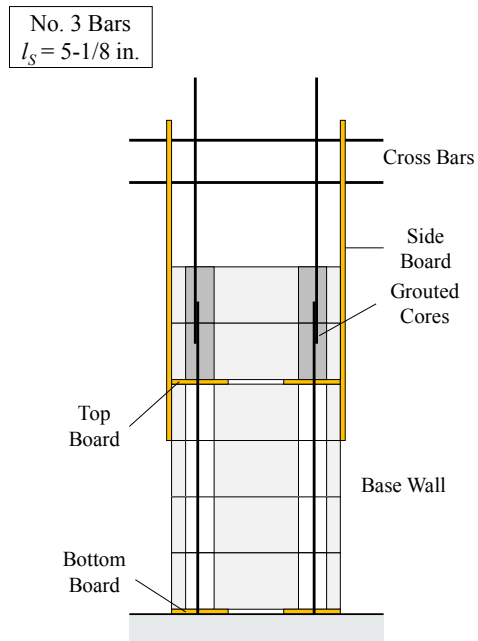
**Table 3.2 Strength of the splice specimens predicted by the 2008 MSJC Code**

| Bar Properties |                           | Yield Strength | Full Splice Length |              | Reduced Splice Length |              |           |
|----------------|---------------------------|----------------|--------------------|--------------|-----------------------|--------------|-----------|
| Bar Diameter   | $A_s$ (in. <sup>2</sup> ) | $F_y$ (kips)   | $l_d$ (in.)        | $F_d$ (kips) | $l_s$ (in.)           | $F_s$ (kips) | $F_y/F_s$ |
| No. 3          | 0.11                      | 6.60           | 8.25               | 8.25         | 5.125                 | 5.12         | 1.29      |
| No. 4          | 0.20                      | 12.00          | 14.81              | 15.00        | 8.000                 | 8.10         | 1.48      |
| No. 5          | 0.31                      | 18.60          | 25.72              | 23.25        | 13.000                | 11.75        | 1.58      |

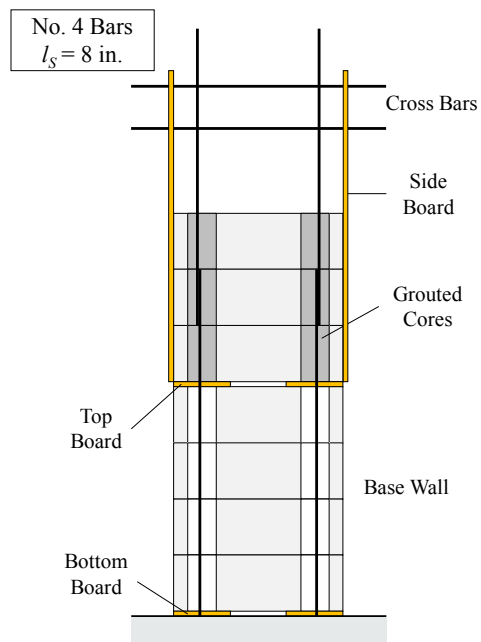
The ratio of the predicted splice capacity as governed by specified yield strength to predicted splice capacity as governed by the reduced splice length was also calculated, and is included in Table 3.2. In designing the splices to be tested, the target value for that ratio was 1.50 to essentially guarantee failure in the splice rather than by yielding of the reinforcing bars. This ratio was set greater than 1.0 to allow for overstrength and strain hardening of reinforcing bars. The ratio for the specimens with No. 3 bars is smaller than the ratio of the other specimens because a compressive strength of 4,000 psi was assumed for the grout in their preliminary design, underestimating it. The specimens with No. 4 and No. 5 bars were re-designed assuming a more accurate grout compressive strength of 5,500 psi, based on the results of grout tests for the first set of specimens.

### 3.4 CONSTRUCTION OF LAP-SPLICE SPECIMENS

Construction of the specimens is shown in Figure 3.4, Figure 3.5, and Figure 3.6. Each set corresponded to a different bar diameter, and was constructed separately. Solid blocks, 8- x 8- x 24-in., were provided by the Autoclaved Aerated Concrete Products Association (AACPA) through Xella Mexicana, S.A. de C.V., in Texas. Two 4-in. diameter cores were wet-drilled in each block as shown in Figure 3.7. Two, three or four blocks were placed in stack bond and joined together using thin-bed mortar, mixed and applied following the manufacturer's instructions as shown in Figure 3.8. Units with cleanouts were used in the bottom course of the specimens with No. 4 and No. 5 bars to allow cleaning the cores and inspecting the splices prior to grouting.

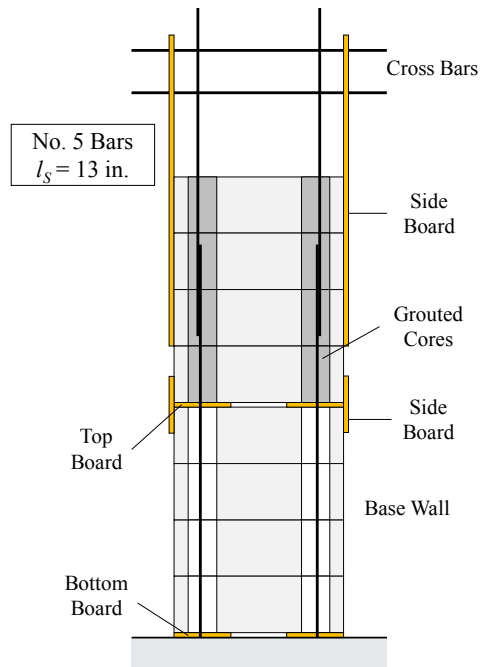


**Figure 3.4 Construction of lap-splice specimens – No. 3 bars**



**Figure 3.5 Construction of lap-splice specimens – No. 4 bars**





**Figure 3.6 Construction of lap-splice specimens – No. 5 bars**



**Figure 3.7 Core drilling of blocks in lap-splice specimens**



***Figure 3.8 Construction of base-walls***

Six base-walls were constructed using four of the same type of blocks, also placed in stack bond and joined together using thin-bed mortar. These walls were used to support the specimens in an upright position during grouting and curing, providing enough clearance from the floor to accommodate the bars projecting through the bottom of the specimens. Four plywood panels with drilled holes were nailed to the base-walls, two at the top and two at the bottom, to hold the bottom bars in place during construction. The two top boards also served to contain the fresh grout. Those boards were covered with plastic sheathing in the set of specimens with the No. 3 bars to break the bond between the grout and the plywood. For the other two sets of specimens, form oil was applied to these pieces instead, because the plastic sheathing proved to be too slippery.

The bonded AAC units were placed on top of the base-walls. Strips of plywood panels were nailed to the ends of the AAC blocks to maintain alignment, to provide stability, and to support cross-bars over the specimens. The spliced reinforcing bars, cut from 20-ft long pieces, were spliced and tied using 6-in. ties. The No. 3 bars were tied with two ties per splice, while the No. 4 and No. 5 bars were tied with three ties per splice. The spliced bars were then inserted from the top of each specimen, down through the base-walls and the plywood, and tied to the cross-bars. The center of each splice was offset towards the surface of the blocks by  $\frac{1}{2}$  in. Figure 3.9 shows No. 3 bars and No. 4 bars spliced inside of a core prior to grouting.

The day before each specimen was grouted, the splices were inspected and the cores cleaned. In the specimens with No. 4 and No. 5 bars, the cleanouts were closed by applying thin-bed mortar to the top and the sides of the same pieces that had been cut out of the AAC blocks, and putting them back in place, as shown in Figure 3.10. Boards were clamped to the front and back of the bottom course so that the fresh grout would not break the bond between the clean-out pieces and the bottom blocks.



***Figure 3.9 Bars spliced inside a core – No. 3 bars (left) and No. 4 bars (right)***



***Figure 3.10 Cleanouts in a lap-splice specimen with No. 5 bars***

Figure 3.11 illustrates the typical setup of the specimens prior to grouting. The specimens were wetted thoroughly 24 hours and again 1 hour before grouting. The cores

with the spliced bars were filled with ASTM C476-09 coarse grout, specified by proportion. Portland cement Type I/II, manufactured sand, pea gravel, and water were mixed, and an initial slump test was conducted in accordance with ASTM C143-08. Based on this initial slump, water was added to the mix to achieve an 11-in. slump. Mixing was then finalized and the specimens grouted. A second slump test was conducted halfway through the grouting process.

Figure 3.12 shows the materials that were mixed to grout the splice specimens containing No. 4 bars. Figure 3.13 is a photograph of the mixing of the grout used in the splice specimens containing No. 5 bars. Figure 3.14 shows the initial slump test prior to grouting the splice specimens containing No. 5 bars.



*Figure 3.11 Splice specimens prior to grouting – No. 5 bars*



*Figure 3.12 Cement, sand, and pea gravel used to grout the specimens with No. 4 bars*



*Figure 3.13 Mixing of the grout used in the splice specimens with No. 5 bars*



***Figure 3.14 Initial slump test – Grout used in splice specimens with No. 5 bars***

Figure 3.15 illustrates the grouting process. A  $\frac{3}{4}$ -in. vibrator was pre-placed in each core, and then the core was filled to the top with grout. The grout was poured through a truncated cone into the cores using 5-gallon buckets. The vibrator was then turned on and extracted in about 10 seconds. After all of the specimens in a set were filled and vibrated, additional grout was poured in each core and the top 2 in. was reconsolidated by puddling with a rod. Finally, the top of each core was leveled with a trowel. The specimens were wetted every other day after grouting, for a week. After removing the side boards and the cross-bars, specimens were lifted from the base-walls with a crane and a scissor-clamp, and were stacked flat one on top of each other on the laboratory floor until testing.



*Figure 3.15 Grouting of lap-splice specimens with No. 5 bars*

### **3.5 MATERIAL TESTING, LAP-SPLICE SPECIMENS**

Samples of the grout and the reinforcing bars were tested. Along with each set of lap-splice specimens, six 4- x 4- x 8-in. grout prisms were fabricated in accordance with ASTM C1019-09 for compressive strength testing (Figure 3.16). AAC blocks were used as molds, with paper towels as permeable liners. The blocks were wetted prior to fabrication, and the prisms were wetted after grouting, exactly the same as the lap-splice specimens. One week after fabrication, the prisms were removed from the molds and stored next to the specimens. Three prisms were tested approximately 28 days after grouting and the other three soon after testing the corresponding lap-splice specimens. Two samples of each bar size were tested by ASTM A370-09a.



**Figure 3.16 Fabrication of grout prisms**

### **3.6 SUMMARY OF MATERIAL TEST RESULTS, LAP-SPLICE SPECIMENS**

The compressive strengths of the grout in the splice specimens are summarized in Table 3.3, Table 3.4, and Table 3.5. The first three specimens of each set were tested approximately 28 days after grouting, and the last three soon after finalizing the corresponding splice tests. The slump of each grout mix and the dimensions of the grout prisms are included in Appendix C.

**Table 3.3 Compressive strength of grout in lap-splice specimens with No. 3 bars**

| Grout Prism | Area (in. <sup>2</sup> ) | Load (kips) | Strength (ksi) | Average (ksi) |
|-------------|--------------------------|-------------|----------------|---------------|
| N3P1        | 16.61                    | 93.10       | 5.61           | 5.45          |
| N3P2        | 15.86                    | 85.60       | 5.40           |               |
| N3P3        | 16.76                    | 89.60       | 5.35           |               |
| N3P4        | 16.62                    | 90.60       | 5.45           | 5.38          |
| N3P5        | 18.14                    | 97.50       | 5.38           |               |
| N3P6        | 16.56                    | 88.00       | 5.32           |               |



**Table 3.4 Compressive strength of grout in lap-splice specimens with No. 4 bars**

| Grout Prism | Area (in. <sup>2</sup> ) | Load (kips) | Strength (ksi) | Average (ksi) |
|-------------|--------------------------|-------------|----------------|---------------|
| N4P1        | 17.22                    | 83.40       | 4.84           | 5.08          |
| N4P2        | 16.24                    | 84.40       | 5.20           |               |
| N4P3        | 16.48                    | 85.90       | 5.21           |               |
| N4P4        | 16.65                    | 92.70       | 5.57           | 5.66          |
| N4P5        | 16.52                    | 95.70       | 5.79           |               |
| N4P6        | 16.62                    | 93.60       | 5.63           |               |

**Table 3.5 Compressive strength of grout used in lap-splice specimens with No. 5 bars**

| Grout Prism | Area (in. <sup>2</sup> ) | Load (kips) | Strength (ksi) | Average (ksi) |
|-------------|--------------------------|-------------|----------------|---------------|
| N5P1        | 16.45                    | 78.70       | 4.78           | 4.81          |
| N5P2        | 16.07                    | 76.90       | 4.78           |               |
| N5P3        | 16.41                    | 80.00       | 4.88           |               |
| N5P4        | 16.29                    | 80.10       | 4.92           | 4.93          |
| N5P5        | 16.24                    | 81.20       | 5.00           |               |
| N5P6        | 16.29                    | 79.60       | 4.89           |               |

The yield and ultimate strengths of the reinforcing bars used in the splice specimens are summarized in Table 3.6. The complete stress-strain curves of the samples and a copy of the certified mill reports are included in Appendix C.

**Table 3.6 Summary of test results for reinforcing bars in lap-splice specimens**

| Bar Diameter | Sample      | Yield Strength |              | Ultimate Strength |              |
|--------------|-------------|----------------|--------------|-------------------|--------------|
|              |             | Load (kips)    | Stress (ksi) | Load (kips)       | Stress (ksi) |
| No. 3        | 3A          | 7.49           | 68.06        | 10.60             | 96.36        |
|              | 3B          | 7.47           | 67.88        | 10.58             | 96.21        |
|              | Mill Report | 8.04           | 73.10        | 12.29             | 111.70       |
| No. 4        | 4A          | 12.20          | 61.00        | 19.42             | 97.11        |
|              | 4B          | 12.16          | 60.81        | 19.37             | 96.84        |
|              | Mill Report | 12.50          | 62.50        | 22.10             | 110.50       |
| No. 5        | 5A          | 18.17          | 58.61        | 29.68             | 95.73        |
|              | 5B          | 18.18          | 58.64        | 29.70             | 95.81        |
|              | Mill Report | 19.25          | 62.10        | 30.81             | 99.40        |

### 3.7 LAP-SPLICE TEST SETUP

The lap-splice test setup is shown in Figure 3.1, Figure 3.2, Figure 3.3, and Figure 3.17. Specimens were loaded using a steel frame with a couple of beams and columns connected using threaded rods, and assembled on the laboratory floor. Each beam consisted of two back-to-back channels, separated by 4-1/8 in. This gap allowed passing the reinforcing bars through the beams. Circular pipes welded to base plates were used as compression members to separate the beams.

Two steel plates with a hole in the center were attached to the outside of the top beam. Two 50-kip load cells and two 30-ton rams with through holes were placed against those plates, supported on wood blocks. The rams and a pressure gauge were connected to an air-driven hydraulic pump. Figure 3.18 shows the top beam, the rams and the pump.



***Figure 3.17 Lap-splice test setup***



***Figure 3.18 Rams and pressure gauge connected to air-driven hydraulic pump***

Prior to setting each specimen, the bottom beam was removed. The specimen was then placed on top of 1-in. diameter rollers lying on the floor, as shown in Figure 3.19. The specimen was then rolled into the frame while the bars on one end went through the top beam, the steel plates, the load cells, and the rams. The rollers were left underneath the specimen, allowing it to move freely during the test.

With the specimen inside the frame, the bottom beam was again installed. Two plates with a hole in their centers were attached on the outside of this beam. Strand chucks were inserted and placed against the plates; their wedges were hand-seated, and the caps were installed on the chucks. Similarly, steel plates with holes in the center were placed against the outside end of the rams. Two strand chucks were also inserted and placed about 2 in. from these plates; their wedges were also hand-seated, and the caps were installed on the chucks.

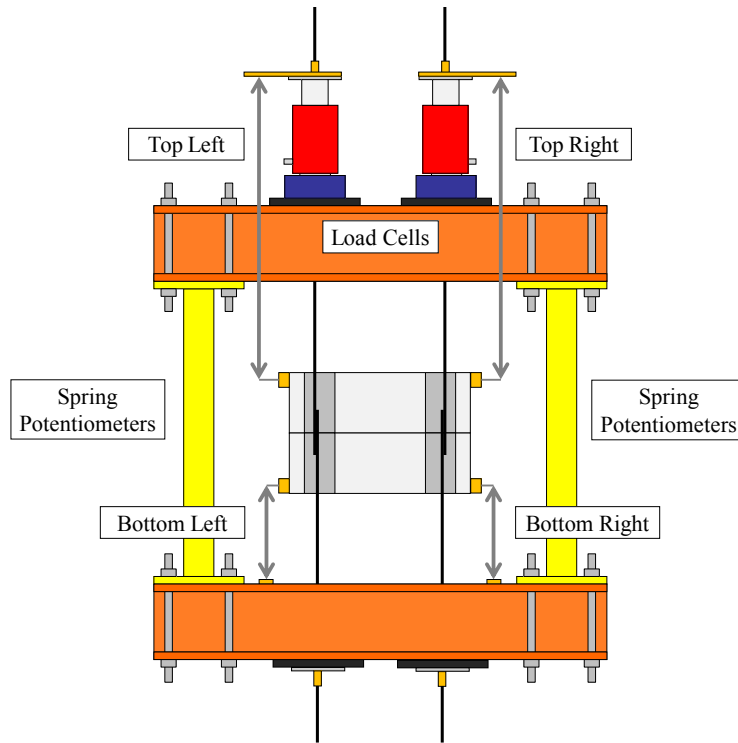


*Figure 3.19 Lap-splice specimen on rollers prior to testing*

### **3.8 INSTRUMENTATION OF LAP-SPLICE SPECIMENS**

The instrumentation used in the lap-splice tests, illustrated in Figure 3.20, included the two load cells noted in Section 3.7 and four 5-in. string potentiometers. The load cells measured the tensile force applied to the left and the right splices. Two of the string potentiometers measured the displacement of the specimen's bottom end corners with respect to the inside of the bottom beam (referred to as "bottom left" and "bottom right"); and the other two measured the displacement of the plates between the rams and the strand chucks with respect to the corners of the other end of the specimen (referred to as "top left" and "top right"). The six instruments were connected to a data acquisition

system with a 10-V power supply and recording data in a desktop computer at a rate of one reading per second. Figure 3.21 and Figure 3.22 show the instrumentation in the top and the bottom end of the specimens, respectively.



**Figure 3.20 Instrumentation – lap-splice test**



*Figure 3.21 Instrumentation – top end of specimen*



*Figure 3.22 Instrumentation – bottom end of specimen*

### **3.9 TESTING PROCEDURE FOR LAP-SPLICE TESTS**

Each lap-splice specimen was tested in two phases. In the first phase, the air-driven hydraulic pump was used to extend both rams, closing the gap between the rams and the strand chucks, and then applying a tensile force to the reinforcing bars. The

specimen was loaded until at least one of the splices failed and the hydraulic pressure in the system dropped. The maximum loads measured by the load cells and registered by the data acquisition system were noted. At that point, the test was paused, and the hydraulic pressure in the system was relieved. The cracks in the specimen were marked; the splice that had failed was labeled; its failure mechanism was noted, and the specimen was photographed.

In the second phase, the ram corresponding to the splice that had failed was disconnected from the pump, and the other splice was loaded until it also failed. The maximum load measured by the load cell and registered by the data acquisition system during the second phase was noted. At this point, the test was stopped, and the hydraulic pressure was relieved. The cracks in the specimen were marked; the second failed splice was labeled; its failure mechanism was noted; and the specimen was photographed.

At the end of each test, the spring potentiometers were removed, along with the strand chucks and the bottom beam. The specimen was rolled out of the frame, inspected, and photographed.

The specimens were loaded in both phases with a target rate of 30 ksi/min (in terms of the stress applied to the reinforcing bars), based on the range recommended in ASTM A370-09a and ASTM A1034-05b (10 ksi/min to 100 ksi/min.). It was especially difficult to load the specimens at the target rate during the second phase because the pump was too powerful. A smaller pump would have allowed a better control of the rate.

### **3.10 SUMMARY OF THE SPLICE-TEST RESULTS**

The results of the lap-splice tests are summarized in Table 3.7, Table 3.8, and Table 3.9. These tables include the maximum load applied to each splice during each test phase, as well as the overall maximum for each splice. In all of the specimens, only one splice failed during the first phase of the test, except in the last specimen containing No. 3 bars (Specimen N3S6). In that one, both splices failed at the end of the first phase.

Table 3.7, Table 3.8, and Table 3.9 also include the strength ratio between the overall maximum applied load and the capacity predicted by the 2008 MSJC *Code*

(MSJC 2008a) provisions for each splice, factored by the ratio of the splice length provided to that required. For each set of specimens, the average, the estimated standard deviation (s), and the coefficient of variation (COV) of the overall maximum applied loads were calculated, and are included in the tables.

**Table 3.7 Summary of test results – Splice specimens with No. 3 bars**

| Specimen | Maximum Applied Load (Kips) |       |         |       |         |       | Observed Splice Capacity / MSJC Capacity |       |
|----------|-----------------------------|-------|---------|-------|---------|-------|--|-------|
|          | Phase 1                     |       | Phase 2 |       | Overall |       | Left                                     | Right |
|          | Left                        | Right | Left    | Right | Left    | Right |  |       |
| N3S1     | 6.30                        | 6.34  | 6.77    | -     | 6.77    | 6.34  | 1.32                                     | 1.24  |
| N3S2     | 6.21                        | 6.30  | 5.69    | -     | 6.21    | 6.30  | 1.21                                     | 1.23  |
| N3S3     | 6.19                        | 6.20  | 7.06    | -     | 7.06    | 6.20  | 1.38                                     | 1.21  |
| N3S4     | 6.02                        | 5.93  | 6.76    | -     | 6.76    | 5.93  | 1.32                                     | 1.16  |
| N3S5     | 5.81                        | 5.87  | -       | 6.30  | 5.81    | 6.30  | 1.13                                     | 1.23  |
| N3S6     | 6.40                        | 6.38  | -       | -     | 6.40    | 6.38  | 1.25                                     | 1.25  |
| Average  | 6.15                        | 6.17  | 6.57    | 6.30  | 6.37    |       | 1.24                                     |       |
| s        | -                           | -     | -       | -     | 0.35    |       | 0.07                                     |       |
| COV      | -                           | -     | -       | -     | 5.5%    |       | 5.5%                                     |       |

**Table 3.8 Summary of test results – Splice specimens with No. 4 bars**

| Specimen | Maximum Applied Load (Kips) |       |         |       |         |       | Observed Splice Capacity / MSJC Capacity |       |
|----------|-----------------------------|-------|---------|-------|---------|-------|--|-------|
|          | Phase 1                     |       | Phase 2 |       | Overall |       | Left                                     | Right |
|          | Left                        | Right | Left    | Right | Left    | Right |  |       |
| N4S1     | 8.40                        | 8.41  | 8.51    | -     | 8.51    | 8.41  | 1.05                                     | 1.04  |
| N4S2     | 7.79                        | 7.78  | -       | 7.54  | 7.79    | 7.78  | 0.96                                     | 0.96  |
| N4S3     | 8.85                        | 8.91  | 3.65    | -     | 8.85    | 8.91  | 1.09                                     | 1.10  |
| N4S4     | 7.62                        | 7.68  | 8.10    | -     | 8.10    | 7.68  | 1.00                                     | 0.95  |
| N4S5     | 7.66                        | 7.70  | 8.37    | -     | 8.37    | 7.70  | 1.03                                     | 0.95  |
| N4S6     | 8.74                        | 8.81  | -       | 9.00  | 8.74    | 9.00  | 1.08                                     | 1.11  |
| Average  | 8.18                        | 8.21  | 7.16    | 8.27  | 8.32    |       | 1.03                                     |       |
| s        | -                           | -     | -       | -     | 0.50    |       | 0.06                                     |       |
| COV      | -                           | -     | -       | -     | 6.0%    |       | 6.0%                                     |       |



**Table 3.9 Summary of test results – Splice specimens with No. 5 bars**

| Specimen | Maximum Applied Load (Kips) |       |         |       |         |       | Observed Splice Capacity / MSJC Capacity |       |
|----------|-----------------------------|-------|---------|-------|---------|-------|--|-------|
|          | Phase 1                     |       | Phase 2 |       | Overall |       | Left                                     | Right |
|          | Left                        | Right | Left    | Right | Left    | Right |  |       |
| N5S1     | 12.58                       | 12.50 | -       | 12.54 | 12.58   | 12.54 | 1.07                                     | 1.07  |
| N5S2     | 12.33                       | 12.24 | -       | 14.09 | 12.33   | 14.09 | 1.05                                     | 1.20  |
| N5S3     | 13.11                       | 13.11 | 9.78    | -     | 13.11   | 13.11 | 1.12                                     | 1.12  |
| N5S4     | 12.23                       | 12.31 | -       | 11.31 | 12.23   | 12.31 | 1.04                                     | 1.05  |
| N5S5     | 11.46                       | 11.55 | -       | 11.40 | 11.46   | 11.55 | 0.98                                     | 0.98  |
| N5S6     | 11.54                       | 11.58 | -       | 9.51  | 11.54   | 11.58 | 0.98                                     | 0.99  |
| Average  | 12.21                       | 12.22 | 9.78    | 11.77 | 12.37   |       | 1.05                                     |       |
| s        | -                           | -     | -       | -     | 0.79    |       | 0.07                                     |       |
| COV      | -                           | -     | -       | -     | 6.4%    |       | 6.4%                                     |       |

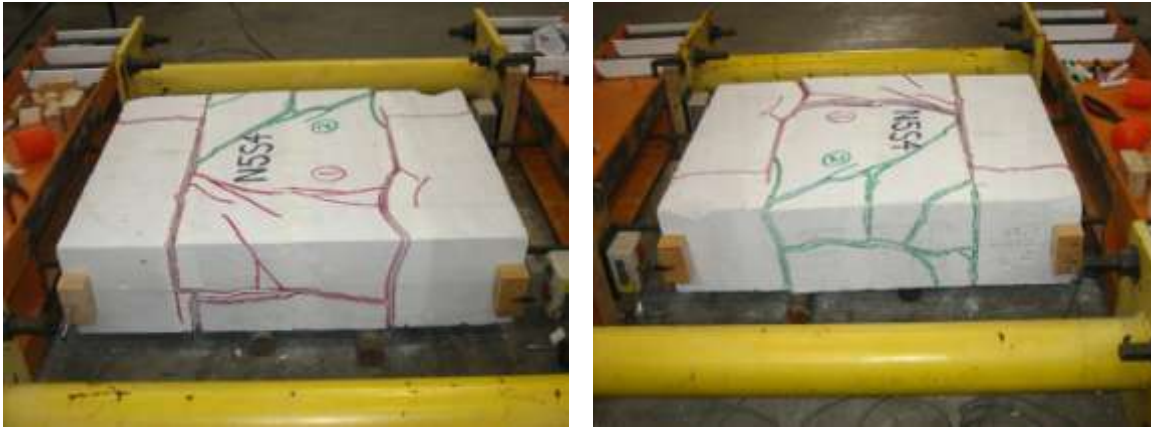
All test specimens failed in the splices themselves, due to splitting of the gout and the AAC blocks. Figure 3.23, Figure 3.24, and Figure 3.25 illustrate typical specimens after testing. A photographic record of the specimens after testing is presented in Appendix A.



**Figure 3.23 Specimen N3S6 – Left and right splices**



*Figure 3.24 Specimen N4S4 – Left and right splices*



*Figure 3.25 Specimen N5S4 – Left and right splices*

Inspection of the specimens after testing confirmed that all failed due to longitudinal splitting of the grout. The pieces of the specimens were set apart and photographed during this inspection as shown in Figure 3.26, Figure 3.27, and Figure 3.28. Evidence of proper consolidation of the grout surrounding the splices was revealed by this inspection, except in the case of the right splice in Specimen N3S4. A void close to the bottom of the core was found (Figure 3.29), which might have been caused by starting to extract the vibrator before turning it on. The overall strength of this splice was the second lowest in its series of specimens. Thus, improper consolidation of the surrounding grout may have reduced the strength of the splice.



*Figure 3.26 Left splice N3S1 (left) & left splice N3S5 (right)*



*Figure 3.27 Left splice N4S2 (left) & right splice N4S3 (right)*



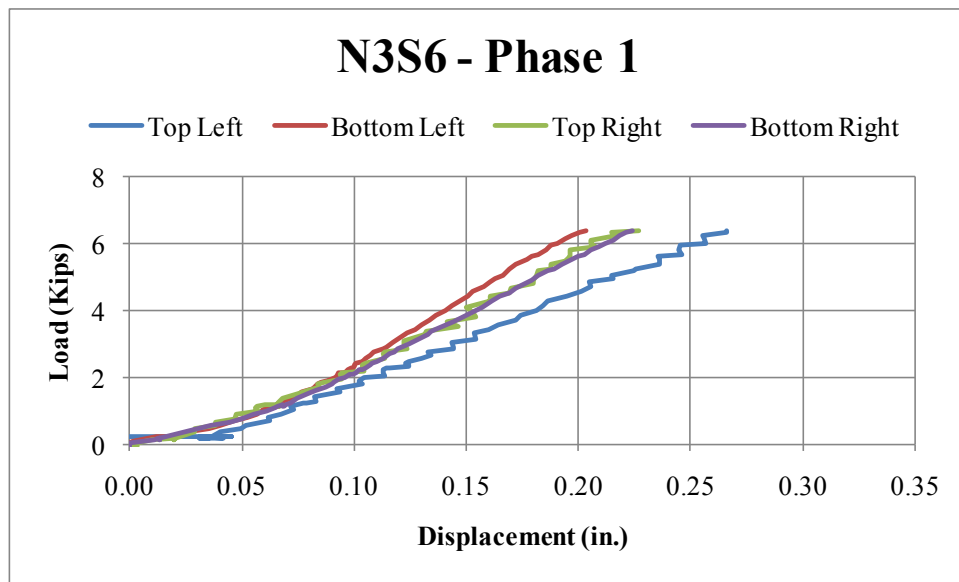
*Figure 3.28 Right splice N5S1 (left) & right splice N5S3 (right)*



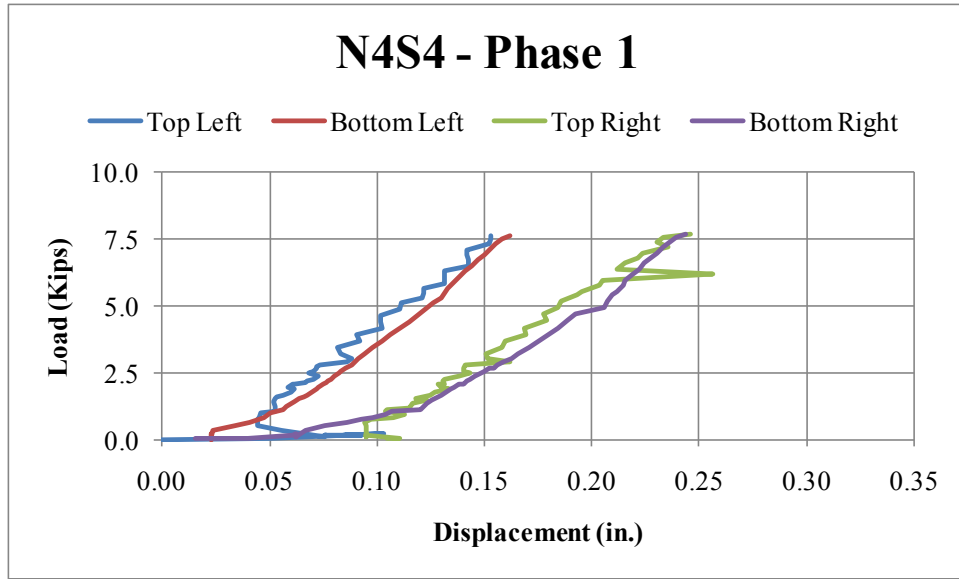
*Figure 3.29 Void in grout surrounding the right splice of Specimen N3S4*

Figure 3.30, Figure 3.31, and Figure 3.32 are representative of the load-displacement responses of the specimens during the first phase of the test. The load-displacement responses of all specimens during the first phase of the test is presented in Appendix A. The data corresponding to the bottom corners was “smoother” – of better quality – than that of the top corners. This is most likely due to the setup used to support

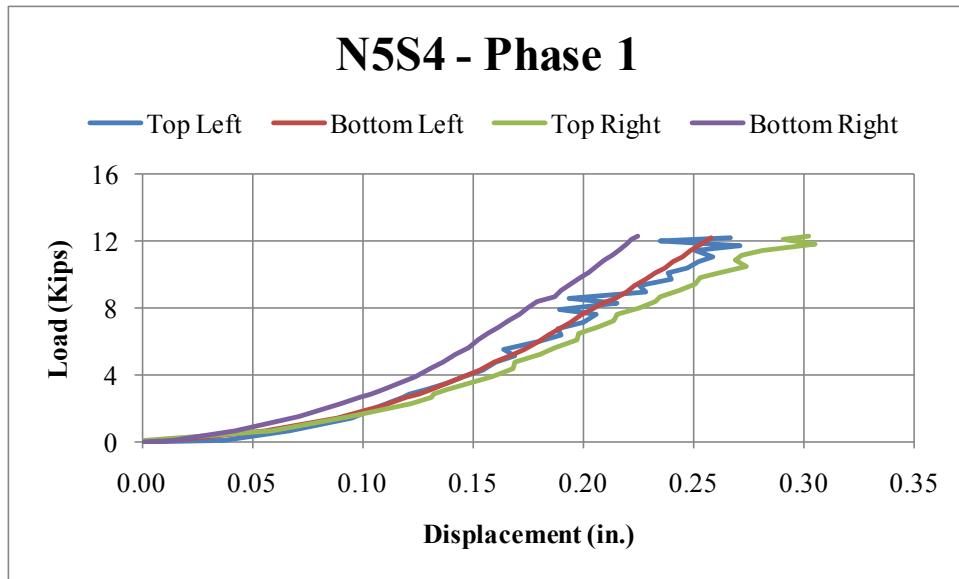
the string potentiometers against the rams. The flexibility of the supports and the friction between the laboratory floor and the wood pieces holding the spring potentiometers resulted in abrupt changes in the displacement records. The load-displacement responses of the test specimens during the first phase of the test show no evidence of slip between the bars and the grout. They also confirm that the reinforcing bars did not yield. The displacement data during the second phase were disregarded because they were of poor quality, due to the difficulty in controlling the loading rate in this phase of the test.



*Figure 3.30 Load-displacement response – Specimen N3S6*



*Figure 3.31 Load-displacement response – Specimen N4S4*



*Figure 3.32 Load-displacement response – Specimen N5S4*

### 3.11 SIGNIFICANCE OF THE SPLICE-TEST RESULTS

As shown in Table 3.7, Table 3.8, and Table 3.9, the ratios of the average observed strengths of the specimens containing No. 3, No. 4, and No. 5 bars, divided by

the strengths predicted by the 2008 MSJC *Code* (MSJC 2008a), and including the effect of the reduced splice lengths, are equal to 1.24, 1.03, and 1.05, respectively, with corresponding coefficients of variation of 5.5%, 6.0%, and 6.4%. Because the average observed strength exceeds the predicted strength for each set, the 2008 MSJC provisions for lap-splices in AAC masonry are safe. Because the coefficients of variation are low, the 2008 MSJC provisions are reliable.

The 2008 MSJC provisions for the design of lap splices in AAC masonry are an extension of those for clay and concrete masonry, which are based on the strength of splice specimens that failed due to longitudinal splitting of the masonry. The fact that the entire AAC splice-test specimens failed due to splitting of the grout and the AAC blocks proves that the extension is consistent. Neglecting the possible contribution of the AAC masonry itself, and including only the grout, is safe and reasonable.

The ratio of the observed to predicted capacities is greater in the specimens with No. 3 bars than those with No. 4 and No. 5 bars for two reasons. First, as bar diameter increases, the dominant failure mode of splices changes from bond to splitting. Because the 2008 MSJC splice provisions are based on a splitting-type equation, they may inherently underestimate the capacity of splices using small bar sizes. Second, the 2008 MSJC splice-length equation may not be uniformly accurate over the full range of bar sizes.

In most of the specimens, the maximum applied load during the second phase of the test was comparable to the load applied in the first phase, except in the case of the third specimen containing No. 4 bars (Specimen N4S3). The maximum load applied to the left splice of this specimen during the second phase of the test was only 41% of the load applied to it in the first phase. Extensive cracking over both splices was observed at the end of the first phase when it was tested. The residual capacity of a lap-splice in AAC masonry is comparable to the original capacity under monotonic loading as long as there is no extensive cracking. Additional research is required to validate this conclusion.

## CHAPTER 4

### Testing of Interface Shear Transfer

#### 4.1 INTRODUCTION

In this chapter, testing of the interface shear transfer is reported, including the following:

- description of the pullout specimens;
- predicted strength of specimens;
- construction of pullout specimens;
- material testing and material test results;
- pullout test setup and instrumentation;
- testing procedure of pullout specimens;
- results of pullout tests; and
- significance of the pullout-test results.

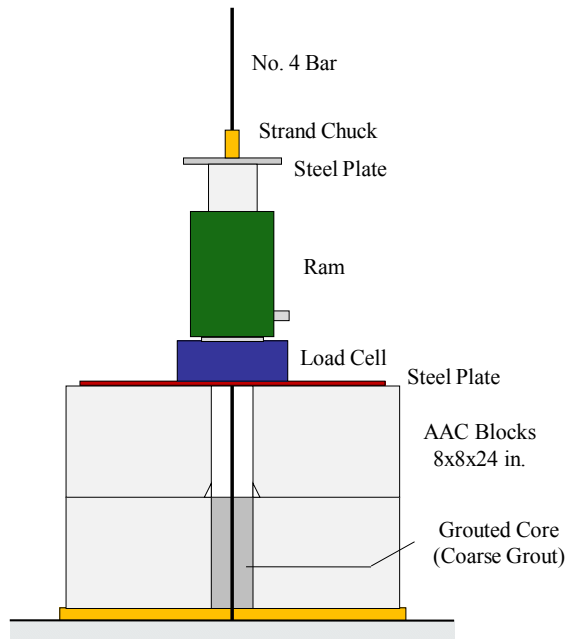
#### 4.2 PULLOUT SPECIMENS

To verify and refine the nominal capacity specified by the 2008 MSJC *Code* (MSJC 2008a) for the interface shear transfer between grout and AAC, eighteen replicates of the pullout specimen shown in Figure 4.1 were constructed and tested. Each specimen was made of a solid unit (8- x 8- x 24-in.) of Class 4 AAC with a 3-in. diameter core in the center. A reinforcing bar, conforming to Grade 60 of ASTM A615-09, was placed in the center of the core. A No. 4 bar was used, from the same heat as the same-diameter bars used in the lap-splice specimens. The core was filled with ASTM C476-09 coarse grout, specified by proportion and consolidated in accordance with the 2008 MSJC *Specification* (MSJC 2008b).

The specimens were tested at least 28 days after fabrication. During the test, the ram was extended, applying tension to the reinforcing bar, splitting forces on the grouted core, shear forces between the bar and the grout, and shear forces at the interface between



the grout and the block. Possible failure mechanisms were fracturing of the bar, splitting of the grout, bond failure between the bar and the grout, and bond failure between the grout and the AAC.



**Figure 4.1 Pullout specimen**

### 4.3 PREDICTED STRENGTH OF THE PULLOUT SPECIMENS

The expected strength of the specimens as governed by the different failure mechanisms is summarized in Table 4.1.

**Table 4.1 Summary of expected strengths – Pullout specimens**

| Mechanism                                      | Basis          | Strength (kips) |
|--|----------------|-----------------|
| interface shear transfer between grout and AAC | 2008 MSJC Code | 2.79            |
|  | Tanner (2003)  | 4.37            |
| bar yield                                      | Material Test  | 12.18           |
| bar fracture                                   |                | 19.40           |
| bond between bar and grout or grout splitting  | 2008 MSJC Code | 5.88            |

Based on the nominal interface shear strength of 37 psi between grout and AAC, specified by the 2008 MSJC *Code* (MSJC 2008a), the expected strength of the pullout specimens was 2.79 kips. Based on the average strength of 58 psi reported by Tanner (2003) for the same mechanism, the expected strength was 4.37 kips.

Based on the average of the test results of the No. 4 bars, the expected strength of the pullout specimens was 12.18 kips and 19.40 kips, as governed by yielding and fracturing of the reinforcing bar, respectively.

The expected strength of the specimens as governed by bond failure between the bar and the grout, or splitting of the grout, was evaluated based on the development length provisions of the 2008 MSJC *Code* (MSJC 2008a). The required length was calculated using the average tested compressive strength of the grout and the specified yield strength of the reinforcing bar. A summary of this calculation is presented in Table 4.2. The length required by the *Code* corresponds to a stress in the reinforcing bar of  $1.25 f_y$ . If a reduced length is provided, the expected strength corresponds to that stress multiplied by the ratio of the reduced and the required lengths. The expected strength was calculated in this manner using the actual embedment length. This calculation is summarized in Table 4.3.

**Table 4.2 Required development length – Pullout specimen**

| Bar Properties |             | Calculation of $K_{AAC}$ (in.) |             |                            |           | $f_g$ (psi) | $l_d$ (in.) |
|----------------|-------------|--------------------------------|-------------|----------------------------|-----------|-------------|-------------|
| Bar Diameter   | $d_b$ (in.) | 5 $d_b$                        | Grout Cover | Clear spacing between bars | $K_{AAC}$ |             |             |
| No. 3          | 0.375       | 1.875                          | 1.3125      | -                          | 1.3125    | 5,550       | 11.22       |

Table 4.3 uses the following notation:

- $F_y$  = expected strength of pullout specimen as governed by bar yield
- $F_{ld}$  = expected strength of pullout specimen as governed by bond or splitting failure between the bar and the grout, using the *Code*-specified development length

$F_{lr}$  = expected strength of pullout specimen as governed by bond or splitting failure between the bar and the grout, using the reduced development length

**Table 4.3 Expected strength – Governed by bar-yield, bar-grout bond, or grout splitting**

| Bar Properties |                           | Yield Strength | Full Length |                 | Reduced Length |                 |
|----------------|---------------------------|----------------|-------------|-----------------|----------------|-----------------|
| Bar Diameter   | $A_s$ (in. <sup>2</sup> ) | $F_y$ (kips)   | $l_d$ (in.) | $F_{ld}$ (kips) | $l_r$ (in.)    | $F_{lr}$ (kips) |
| No. 3          | 0.11                      | 6.60           | 11.22       | 8.25            | 8.00           | 5.88            |

#### 4.4 CONSTRUCTION OF THE PULLOUT SPECIMENS

Construction of the pullout specimens is shown in Figure 4.3. Solid blocks 8- x 8- x 24-in. were provided by the Autoclaved Aerated Concrete Products Association (AACPA) through Xella Mexicana, S.A. de C.V., in Texas. A 3-in. diameter core was wet-drilled in each block, similar to that shown in Figure 3.7. Two strips of plywood with drilled holes at 10 in. on center were placed on the laboratory floor, and form oil was applied on them to break the bond with the grout. Nine blocks were placed over each strip, centered over the holes. At the ends of the strips, wood stands supported two continuous cross-bars over each row of specimens.



*Figure 4.2 Core drilling of holes in specimens (repeated from Chapter 3)*



*Figure 4.3 Pullout specimens prior to grouting*

Eighteen No. 4 bars, 4-ft long, were cut from 20-ft long pieces. A bar was introduced in each block from the top, through the core, and into the hole in the plywood. The hole held the bar in place during construction. The bar was tied to the two cross-bars

over the specimen using 6-in. ties. In addition, four sets of diagonal bars were placed over the two rows of specimens, and tied to the cross-bars for bracing.

The cores were wetted thoroughly 1 ½ hours and again ½ hour before grouting. The cores were filled with ASTM C476-09 coarse grout, specified by proportion. Portland cement Type I/II, manufactured sand, pea gravel, and water were mixed, and an initial slump test was conducted in accordance with ASTM C143-08. Based on this initial slump, water was added to the mix to achieve an 11-in. slump. A second slump test was done after grouting. Figure 4.4 is a picture of the mixer that was used to produce the grout.

The grout was poured in the cores in two equal layers using a medium size trowel, and each layer was consolidated by puddling with a rod. After all of the specimens were filled and consolidated, additional grout was poured in each core and the top 2-in. was reconsolidated. Finally, the top of each core was leveled with a trowel. Figure 4.5 shows the specimens after grouting. The specimens were wetted every other day after grouting, for a week, and left in place until testing.



*Figure 4.4 Mixer used to produce the grout*



*Figure 4.5 Pullout specimens after grouting*

#### **4.5 MATERIAL TESTING, PULLOUT SPECIMENS**

Samples of the grout and the reinforcing bars were tested. Along with the specimens, six 4- x 4- x 8-in. grout prisms were fabricated in accordance with ASTM C1019-09 for compressive strength testing (Figure 4.6). AAC blocks were used as molds, with paper towels as permeable liners. The blocks were wetted prior to fabrication, and the prisms were wetted after grouting, exactly the same as the pullout specimens. One week after fabrication, the prisms were removed from the fabrication setup and stored next to the specimens. Three prisms were tested approximately 28 days after grouting and the other three soon after testing the pullout specimens. Two samples of the reinforcing bars were tested by ASTM A370-09a.



*Figure 4.6 Fabrication of grout prisms*

#### **4.6 SUMMARY OF MATERIAL TEST RESULTS, PULLOUT SPECIMENS**

The compressive strength of the grout in the pullout specimens is summarized in Table 4.4. The first three prisms were tested approximately 28 days after grouting, and the last three soon after finalizing the pullout tests. The result of the third prism was disregarded; inadequate capping resulted in a flexure failure rather than a compression one. The slump of each grout mix and the dimensions of the grout prisms are included in Appendix C. The reinforcing bars used in the pullout specimens belonged to the same heat of the No. 4 bars that were used in the splice specimens. The yield and the ultimate strength for these bars are included in Table 3.6. The complete stress-strain curve of the bar samples and a copy of the certified mill report are included in Appendix C.

**Table 4.4 Compressive strength of grout in pullout specimens**

| Grout Prism | Area (in. <sup>2</sup> ) | Load (kips) | Strength (ksi) | Average (ksi) |
|-------------|--------------------------|-------------|----------------|---------------|
| AP1         | 17.18                    | 68.35       | 3.98           | 4.00          |
| AP2         | 17.34                    | 69.92       | 4.03           |               |
| AP3         | 16.87                    | 33.84       | -              |               |
| AP4         | 17.06                    | 93.90       | 5.50           | 5.55          |
| AP5         | 16.93                    | 90.70       | 5.36           |               |
| AP6         | 16.88                    | 97.70       | 5.79           |               |

#### **4.7 PULLOUT TEST SETUP**

The pullout test setup is shown in Figure 4.1 and Figure 4.7. A small length of bar protruded from the bottom of each specimen because the specimens were constructed over plywood with holes that held the bottom end of the reinforcing bars in place. Two 8- x 24-in. pieces of plywood panels were glued together and a hole drilled through the center. This plywood-base was laid flat on the floor, and each specimen placed on top. The drilled hole held the protruding bar while the specimen bore against the plywood-base.

A second block with a 3-in. core, similar to the ones used for the test specimens, was placed on top. The bottom edge of the core of the top block was chamfered to avoid contact between the top block and the grouted core during the test. A steel plate with a hole in the center was placed over the top block. A 25-kip load cell and a ram with through holes were placed on top. The ram was connected to a pressure gauge and a hydraulic hand pump. A small steel plate with a hole was introduced over the top and placed against the ram. Finally, a ½-in. strand chuck was placed about 2 in. over the plate.

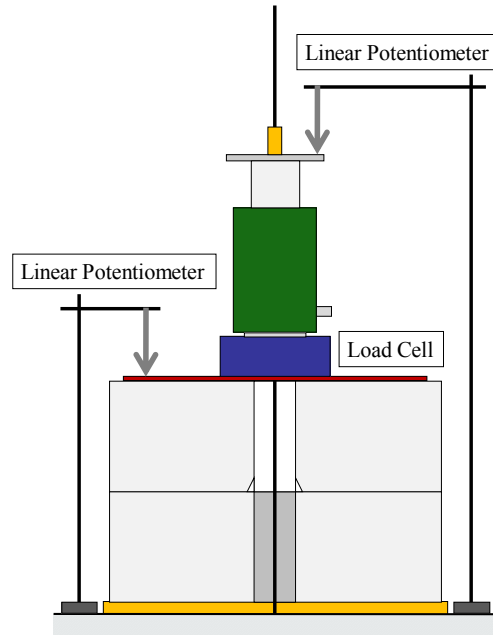




*Figure 4.7 Photograph of pullout test setup*

#### **4.8 INSTRUMENTATION OF PULLOUT SPECIMENS**

The instrumentation used in the pullout tests, shown in Figure 4.7 and Figure 4.8, included the load cell noted in Section 4.6 and two 2-in. linear potentiometers. The load cell measured the tensile force applied to the reinforcing bar. One of the linear potentiometers measured the displacement of the steel plate bearing on the top block, and the other one the displacement of the plate bearing on the ram, both with respect to the floor. The relative displacement between the plates was calculated using the difference between their readings. The three instruments were connected to a data acquisition system with a 10-V power supply and recording data in a laptop computer at a rate of one reading per second.



*Figure 4.8 Instrumentation – pullout tests*

#### 4.9 TESTING PROCEDURE FOR PULLOUT TESTS

The hydraulic hand pump was used to extend the ram, closing the gap between the top plate and the strand chuck, and then applying a tensile force to the reinforcing bar. The specimen was loaded until it failed and the hydraulic pressure in the system dropped. At this point, the test ended, and the hydraulic pressure in the system was relieved. The maximum load measured by the load cell and registered by the data acquisition system during the test was noted. The linear potentiometers, the strand chuck, the steel plates, the ram, and the load cell were then removed. The cracks in the specimen were marked; the failure mechanism was noted; and the specimen was photographed.

The top block split when the first specimen failed. It was then replaced with similar block, but strapped around and prestressed with a clamp. This allowed reusing the same block to test the second through ninth specimens, even though it split when the second specimen failed. Similarly, a third block was used to test the tenth through eighteenth specimens, even though it also split when the tenth specimen failed.

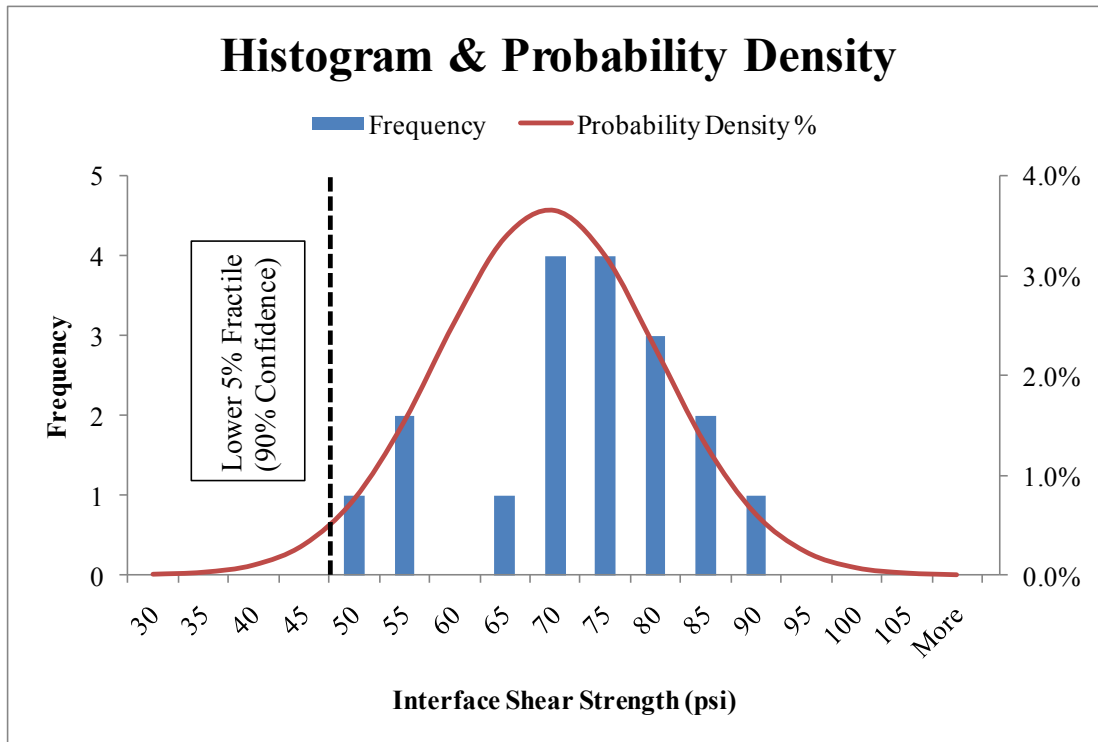
The specimens were loaded with a target rate of 10 ksi/min (in terms of the stress applied to the reinforcing bar). The average rate during the application of the second half of the maximum load was 6.58 ksi/min. It was difficult to load the specimens at the target rate because a hand pump was used.

#### **4.10 SUMMARY OF THE PULLOUT-TEST RESULTS**

The maximum applied load and the corresponding average shear stress for each specimen are presented in Table 4.5. The average shear stress was calculated by dividing the maximum applied load into the surface area between the grout core and the AAC block. The average, median, standard deviations (s), and coefficients of variation (COV) are also included in the table. A histogram of the test results is presented in Figure 4.9.

*Table 4.5 Summary of pullout test results*

| Specimen | Load (kips) | Stress (psi) |
|----------|-------------|--------------|
| AS1      | 6.87        | 91.06        |
| AS2      | 6.03        | 79.96        |
| AS3      | 4.96        | 65.79        |
| AS4      | 6.27        | 83.17        |
| AS5      | 6.05        | 80.18        |
| AS6      | 5.41        | 71.69        |
| AS7      | 5.46        | 72.35        |
| AS8      | 6.59        | 87.39        |
| AS9      | 5.34        | 70.81        |
| AS10     | 6.49        | 86.06        |
| AS11     | 5.75        | 76.23        |
| AS12     | 5.39        | 71.46        |
| AS13     | 6.14        | 81.40        |
| AS14     | 5.76        | 76.36        |
| AS15     | 4.37        | 57.94        |
| AS16     | 3.93        | 52.07        |
| AS17     | 4.22        | 55.93        |
| AS18     | 5.99        | 79.40        |
| Average  | 5.61        | 74.40        |
| Median   | 5.75        | 76.29        |
| s        | 0.82        | 10.91        |
| COV      | 14.66%      |              |



**Figure 4.9 Histogram and probability density of the pullout test results**

Typical specimens after testing are shown in Figure 4.10 and Figure 4.11. A photographic record of the specimens after testing is presented in Appendix B. All of the blocks after testing are shown in Figure 4.12, organized as indicated in the caption, from bottom to top. All of the grout cores with the reinforcing bars, after testing, are shown in Figure 4.13, organized as indicated in the caption, from right to left.



*Figure 4.10 Specimens AS2 (left) and AS3 (right)*



*Figure 4.11 Specimens AS15 (left) and AS18 (right)*



*Figure 4.12 Blocks – AS1 through AS9 (right) & AS10 through AS18 (left)*



*Figure 4.13 Grout cores – AS1 through AS9 (top) & AS10 through AS18 (bottom)*

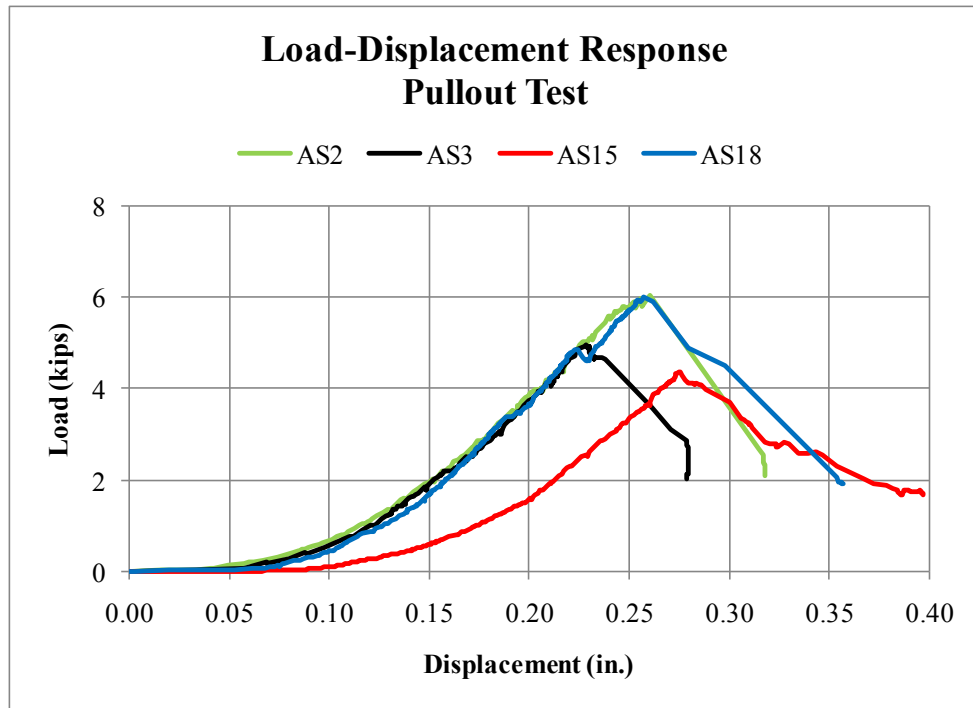
Inspection of the specimens after testing revealed that none of them failed due to longitudinal splitting of the grout. The blocks of AAC split at the end of the test, yet the grout core remained bonded to the reinforcing bars, covered in part by patches of AAC. Stains of grout were also observed on the inner surfaces of the cores of the AAC. Based on these observations, it can be concluded that the strength of the specimens was controlled by a combination of bond failure between the grout and the AAC, and material failure in the AAC surrounding the core.

Predominance of one type of failure was inferred by the extent of the patches of AAC covering the grout core and of the stains of grout on the AAC. Bond failure was predominant where the extent of the patches was lesser, while the extent of the stains was greater. Such is the case with Specimens AS3, AS15, AS16, and AS17. Material failure was predominant where the “patches” was greater, while the extent of the “stains” was lesser. Such is the case with Specimens AS1, AS4, AS8, and AS13. The specimens in which material failure was predominant failed at higher loads than the ones in which bond failure was predominant.

Specimens AS4 and AS10 failed differently from the rest of the specimens. The grout core split transversely close to the bottom third of the core; the top part remained bonded to the bar, while the bottom part remained bonded to the AAC block. In these two specimens, the pullout strength was limited by the strength of the grout in direct tension and the bond between the bottom end of the reinforcing bar and the grout.

The load-displacement response of four specimens during the pullout test is shown in Figure 4.14. This figure is representative of the response of all of the specimens. It shows no evidence of slip between the bar and the grout, or between the grout core and the block. It also confirms that the reinforcing bars did not yield. The load-displacement responses of all specimens during the test are presented in Appendix B.





**Figure 4.14** Load-displacement response – Specimens AS2, AS3, AS15 and AS18

#### 4.11 SIGNIFICANCE OF PULLOUT-TEST RESULTS

Based on the pullout results reported here, the nominal interface shear capacity between grout and AAC of 37 psi, used by the 2008 MSJC *Code*, is very conservative, and could safely be increased to 50 psi.

Nominal capacity ( $X_L$ ) is commonly defined by the lower 5% fractile of the measured strength of a set of specimens, calculated with a 90% confidence. This statistical criterion was evaluated using the following equation:

$$X_L = X_{AV} - ks \qquad \text{Equation 4-1}$$

where  $X_{AV}$  is the average strength,  $s$  is the estimated standard deviation, and  $k$  is the one-sided tolerance limit for a normal distribution. For a lower 5% fractile, a 90% confidence level, and a sample size of 18 specimens,  $k$  is equal to 2.249 (Natrella 1963). Using the results obtained in this testing program, this gives a nominal capacity of 50 psi.

Based on the discussion of the test results in Section 4.10, the capacity to transfer shear from a grout core to the AAC surrounding it is controlled by the interface shear strength between the grout and the AAC, and the strength of the AAC surrounding the grout core. These two controlling mechanisms are lower and upper bounds of the capacity. The capacity to transfer tensile forces from a reinforcing bar to a grout core to the surrounding AAC masonry unit may be governed by bond failure between the bar and the grout, or by splitting of the grout, or by the interface shear strength between the grout and the AAC. In the MSJC *Code*, the first two mechanisms are combined, so that failure is governed by bond failure of the bar or splitting of the grout, or by the interface shear strength between the grout and the AAC. A simple analysis was performed to compare the significance of these two failure mechanisms. The first one was evaluated using the development length ( $l_d$ ) required by the 2008 MSJC *Code* provisions, which corresponds to a tensile force in the reinforcing bar equal to 1.25 times the specified yield strength ( $F_y$ ). This length is a function of the grout cover, the specified yield strength, and the average compressive strength of the grout. It was compared to the length ( $l_b$ ) required to develop the same force as governed by an average interface shear strength of 74.4 psi between grout and AAC. The average strength was used instead of the proposed nominal capacity for consistency because the development length provisions are also related to average expected strengths.

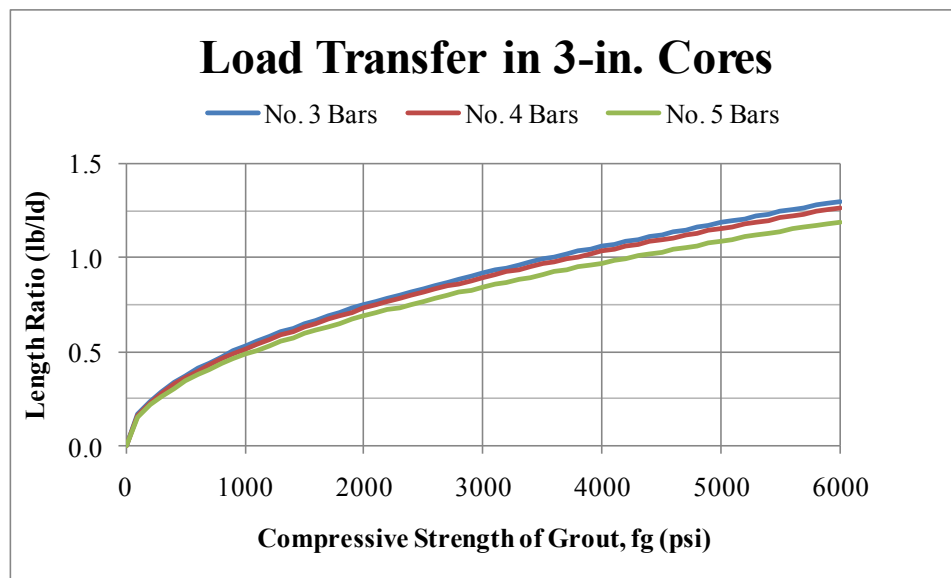
The ratio ( $l_b/l_d$ ) of the required length based on interface shear strength to the development length was calculated for No. 3, No. 4, and No. 5 bars in 3-in. and 4-in. grout cores, using compressive strengths for grouts of up to 6,000 psi. A ratio greater than unity means that the required length based on the average interface shear strength between grout and AAC is greater than the development length. A summary of the parameters used in these calculations is presented in Table 4.6. The results of the calculations were plotted and are shown in Figure 4.15 and Figure 4.16.

The results indicate that the capacity to transfer a tensile force from a reinforcing bar to the surrounding AAC masonry is governed by the interface shear strength between

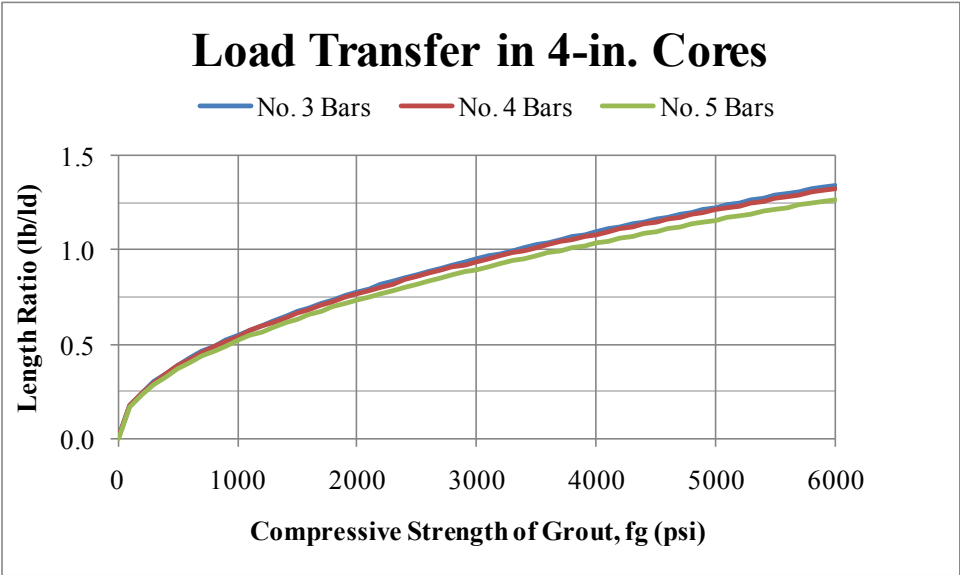
grout and AAC when the compressive strength of the grout is greater than a limiting value. In the case of 3-in. cores, this limiting value is 3,600 psi, 3,800 psi, and 4,300 psi for No. 3, No. 4, and No. 5 bars, respectively. In the case of 4-in. cores, this limit value is 3,300 psi, 3,400 psi, and 3,700 psi for No. 3, No. 4, and No. 5 bars, respectively.

**Table 4.6 Parameters – Development length in 3-in. and 4-in. cores**

| Bar Diameter | $A_s$ (in. <sup>2</sup> ) | $F_y$ (kips) | $1.25 F_y$ (kips) | $K_{AAC}$ (in.) |            |
|--------------|---------------------------|--------------|-------------------|-----------------|------------|
|              |                           |              |                   | 3-in. Core      | 4-in. Core |
| No. 3        | 0.11                      | 6.60         | 8.25              | 1.3125          | 1.8125     |
| No. 4        | 0.20                      | 12.00        | 15.00             | 1.2500          | 1.7500     |
| No. 5        | 0.31                      | 18.60        | 23.25             | 1.1875          | 1.6875     |



**Figure 4.15 Length ratio for reinforcing bars in 3-in. cores**



*Figure 4.16 Length ratio for reinforcing bars in 3-in. cores*

## CHAPTER 5

### Summary, Conclusions, and Recommendations

#### 5.1 SUMMARY

Two testing programs were carried out in the Ferguson Structural Engineering Laboratory of The University of Texas at Austin, with two objectives: first, to verify the requirements of the 2008 MSJC *Code* (MSJC 2008a) for the design of lap-splices in autoclaved aerated concrete (AAC) masonry; and second, to verify and refine the nominal capacity specified by that code for the interface shear transfer between grout and AAC masonry.

To meet the first objective, three sets of six specimens each were constructed and tested using masonry units of Class 4 AAC, joined with thin-bed mortar, and containing lap-splices in 4-in. drilled cores. The cores were filled with ASTM C476-09 coarse grout, specified by proportion. Each set corresponded to a different bar diameter (Nos. 3, 4, and 5). The splices were intentionally placed off-center in the cores by the maximum placement tolerance allowed by the 2008 MSJC *Specification* (MSJC 2008b), and reduced splice lengths were used to prevent yielding or fracturing of the bars prior to splice failure. The specimens failed due to longitudinal splitting of the grout and the AAC blocks. The ratio of the average strength of each set to the strength predicted by the 2008 MSJC *Code* provisions was 1.24, 1.03, and 1.05, for the No. 3, No. 4, and No. 5 bars, respectively, with corresponding coefficients of variation of 5.5%, 6.0%, and 6.4%. These ratios are consistent with the previous calibration of those provisions against test results for clay and concrete masonry.

To meet the second objective, eighteen pullout specimens were constructed and tested using units of Class 4 AAC blocks with 3-in. drilled cores. A reinforcing bar was placed in the center of each core, which was then filled with ASTM C476-09 coarse grout, specified by proportion. The pullout strength of the specimens was controlled by bond failure between the grout and the AAC unit, and material failure in the AAC

surrounding the core. Uniform shear stress values were calculated using the measured pullout strength. These calculated values ranged between 52.1 psi and 91.1 psi, with an average of 74.4 psi, a standard deviation of 10.9 psi, and a coefficient of variation of 14.7%. The lower 5% fractile of the calculated strength of the test specimens, with a 90% confidence, was 50 psi.

## 5.2 CONCLUSIONS

- 1) The requirements of the 2008 MSJC *Code* for the design of lap splices of No. 3, 4, and 5 bars in AAC masonry are safe and reliable, even if the maximum placement tolerance permitted by the 2008 MSJC *Specification* (MSJC 2008b) is allowed for.
- 2) The 2008 MSJC *Code* provisions for the design of lap splices in AAC masonry are an extension of those for clay or concrete masonry, which are based on the strength of splice specimens that failed due to longitudinal splitting of the masonry. Considering that the lap-splice specimens reported in this thesis failed due to splitting of the grout and the AAC blocks, that extension is consistent. In that extension, neglecting the possible contribution of the AAC masonry itself to the capacity of the lap-splice, and including only the grout, is safe and reasonable.
- 3) The nominal capacity specified by the 2008 MSJC *Code* for the interface shear transfer between grout and AAC masonry (37 psi) is very conservative compared to the actual strength calculated using pullout tests of grout cores in AAC blocks. Assuming that a lower 5% fractile of the measured strength of a set of specimens, with a 90% confidence, is an appropriate nominal capacity for design, the current nominal capacity may be increased to 50 psi.

### **5.3 RECOMMENDATIONS FOR FUTURE WORK**

#### **5.3.1 Future Work related to Splices in Masonry in General**

The following work is recommended for further study of the behavior of lap splices in masonry in general:

- 1) Testing of lap splices under cyclic loading, a topic of interest in the case of flexure-controlled shear walls subjected to seismic loads.

#### **5.3.2 Future Work related to the Scope of this Thesis**

The following work is recommended for further study of the behavior of lap splices in AAC masonry and the interface shear transfer between grout and masonry units:

- 2) Testing of interface shear transfer between fine grout and AAC units to study the effects of shrinkage on the interface shear strength. Although grout is required to be consolidated and re-consolidated to compensate for initial plastic shrinkage, it is possible that the long-term shrinkage of fine grout could reduce its nominal interface shear capacity, compared to that of coarse grout.
- 3) Compare the probability of failure associated with the recommended nominal interface shear capacity between grout and AAC, with that of the MSJC *Code* equation for the required development length of reinforcing bars. While the nominal interface shear capacity corresponds to the lower 5% fractile with a 90% confidence of the tested pullout strengths of grout cores, the development length equation was calibrated using the ratio of the average strength of tested lap splices to 1.25 times the specified yield strength of the reinforcing bars. These two approaches result in different probabilities of failure.

## APPENDIX A

### Lap-Splice Test: Photos and Load-Displacement Responses

#### A.1 INTRODUCTION

A photographic record of the lap-splice specimens after testing is presented in this Appendix. The load-displacement response of the specimens during the first phase of the test is also presented here.

#### A.2 PHOTOGRAPHIC RECORD



*Figure A.1 Specimen N3S1 – Left and right splices*



*Figure A.2 Specimen N3S2 – Left and right splices*





*Figure A.3 Specimen N3S3 – Left and right splices*



*Figure A.4 Specimen N3S4 – Left and right splices*



*Figure A.5 Specimen N3S5 – Left and right splices*



*Figure A.6 Specimen N3S6 – Left and right splices*



*Figure A.7 Specimen N4S1 – Left and right splices*



*Figure A.8 Specimen N4S2 – Left and right splices*



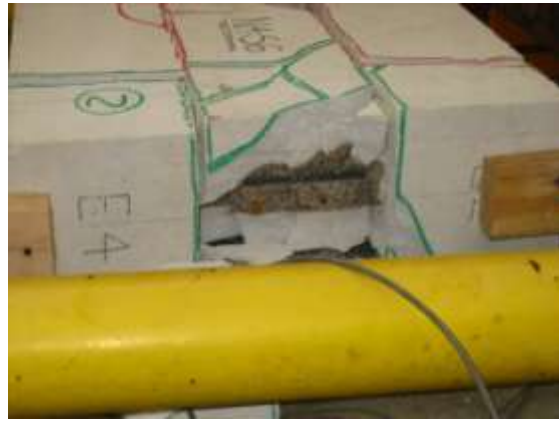
*Figure A.9 Specimen N4S3 – Left and right splices*



*Figure A.10 Specimen N4S4 – Left and right splices*



*Figure A.11 Specimen N4S5 – Left and right splices*



*Figure A.12 Specimen N4S6 – Left and right splices*



*Figure A.13 Specimen N5S1 – Left and right splices*



*Figure A.14 Specimen N5S2 – Left and right splices*



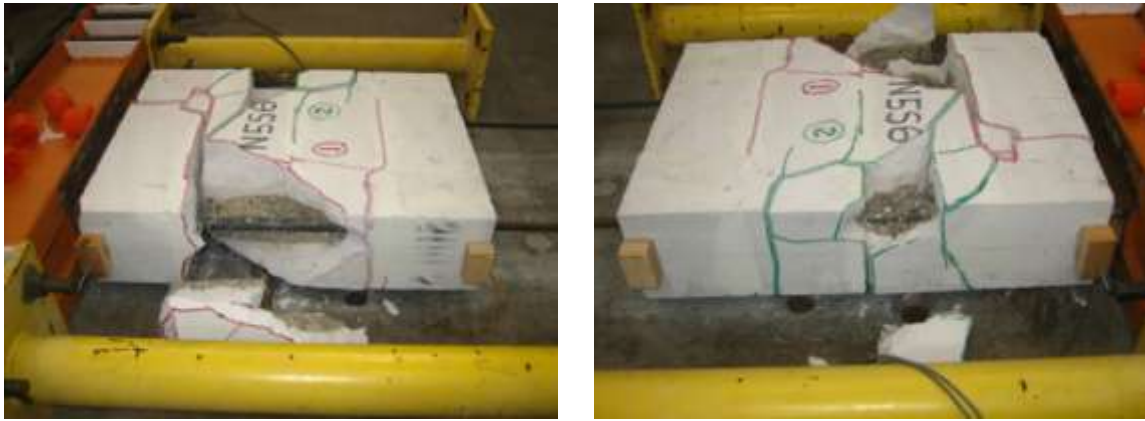
*Figure A.15 Specimen N5S3 – Left and right splices*



*Figure A.16 Specimen N5S4 – Left and right splices*

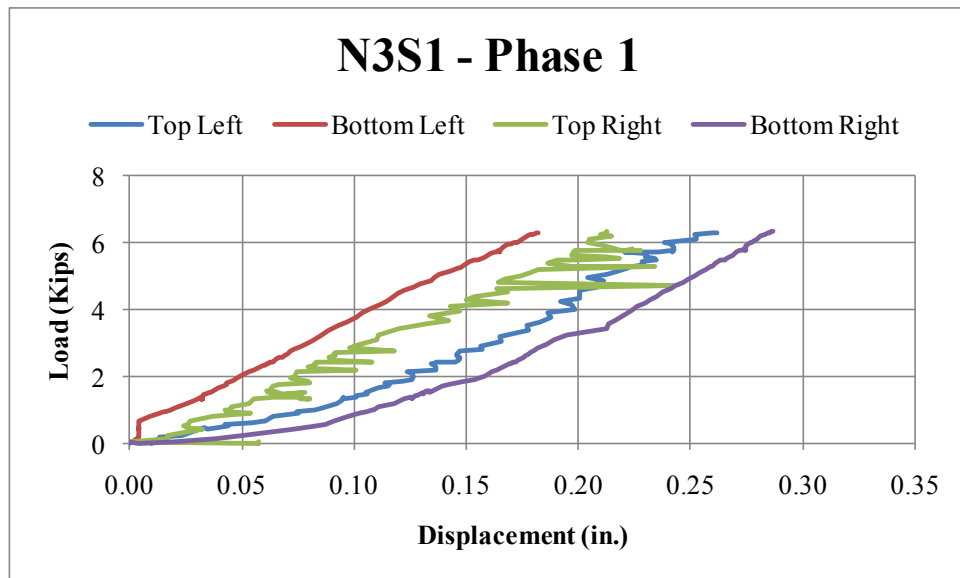


*Figure A.17 Specimen N5S5 – Left and right splices*

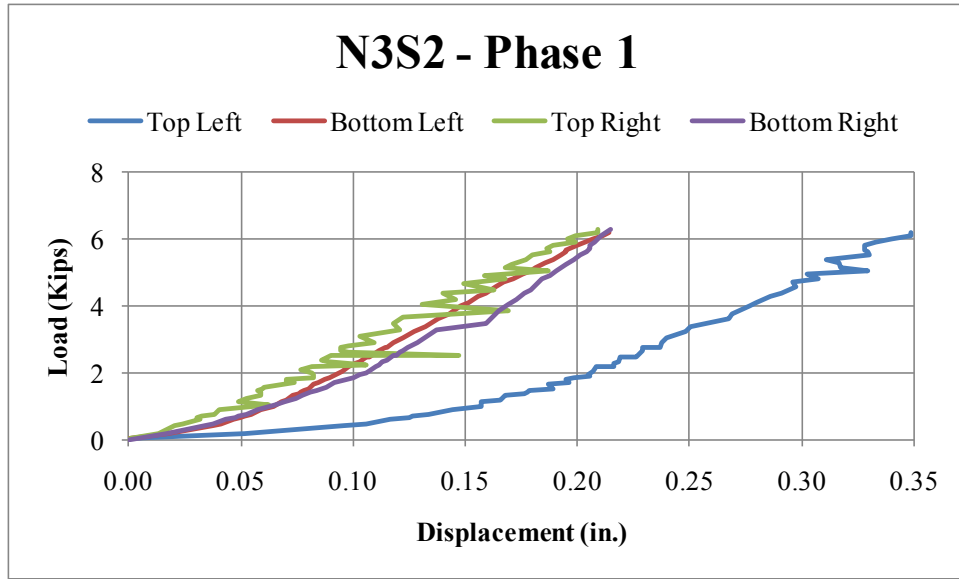


*Figure A.18 Specimen N5S6 – Left and right splices*

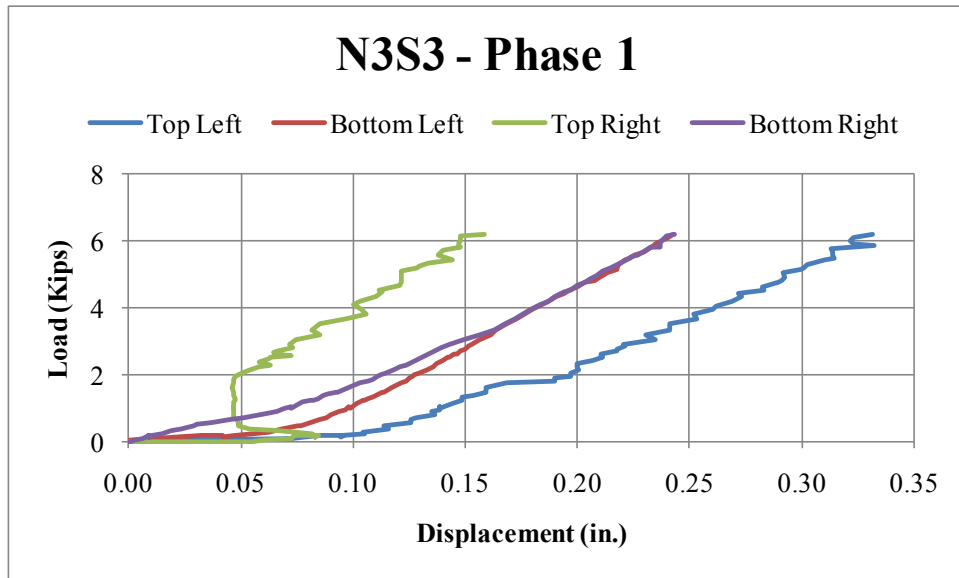
**A.3 LOAD-DISPLACEMENT RESPONSES**



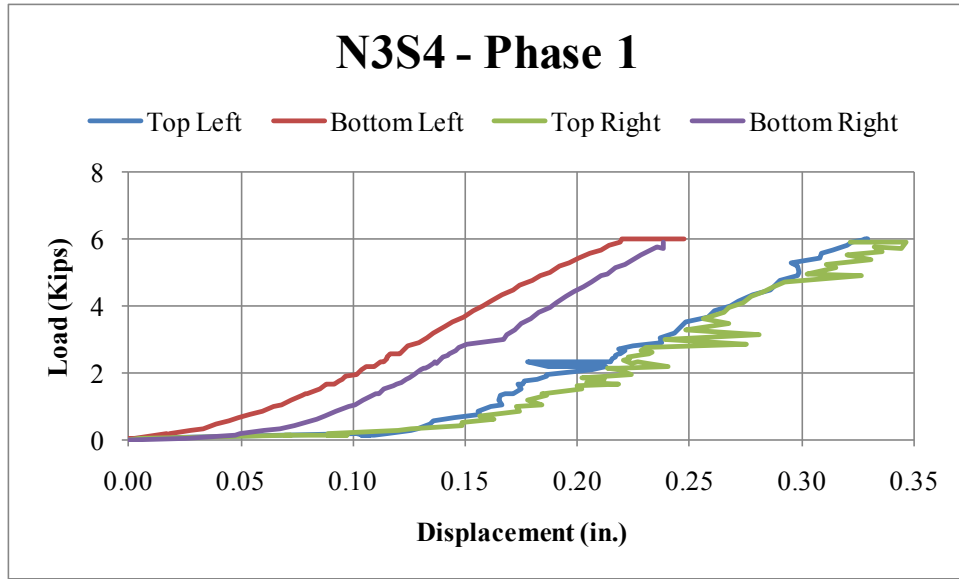
*Figure A.19 Load-displacement response – Specimen N3S1*



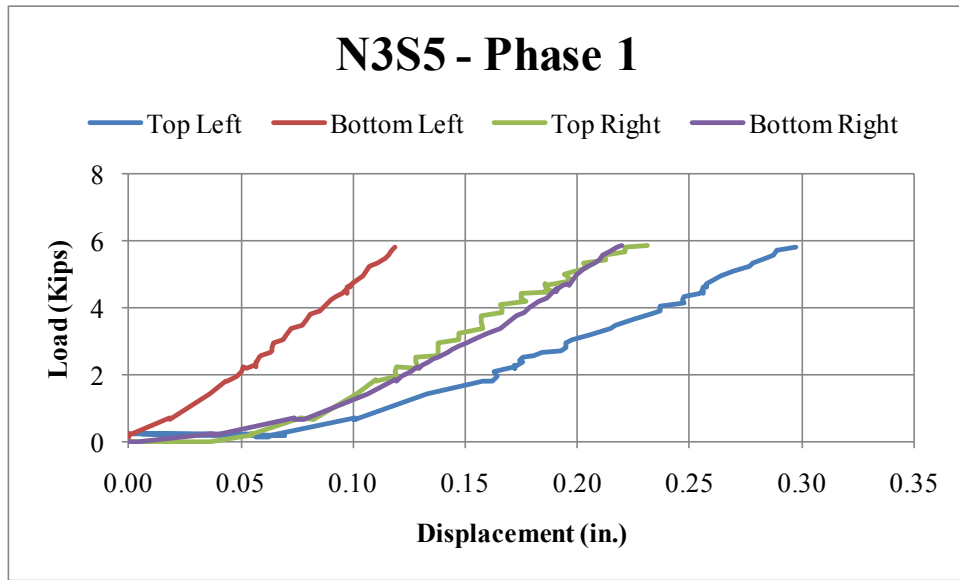
*Figure A.20 Load-displacement response – Specimen N3S2*



*Figure A.21 Load-displacement response – Specimen N3S3*

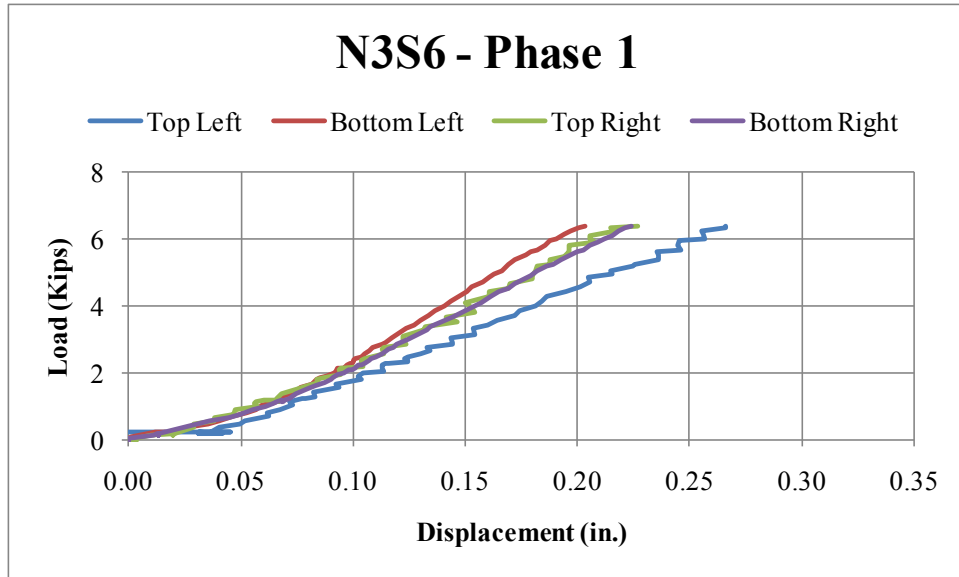


*Figure A.22 Load-displacement response – Specimen N3S4*

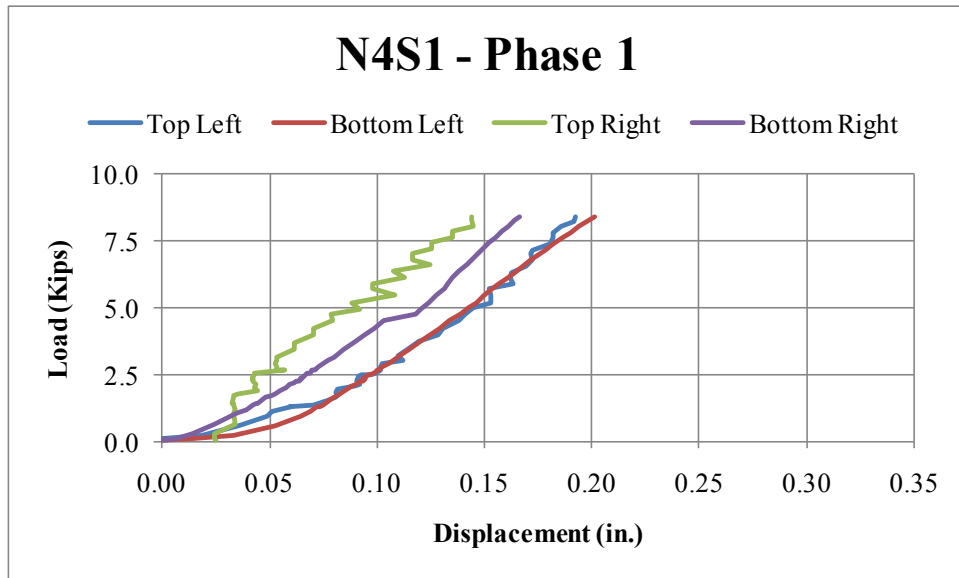


*Figure A.23 Load-displacement response – Specimen N3S5*

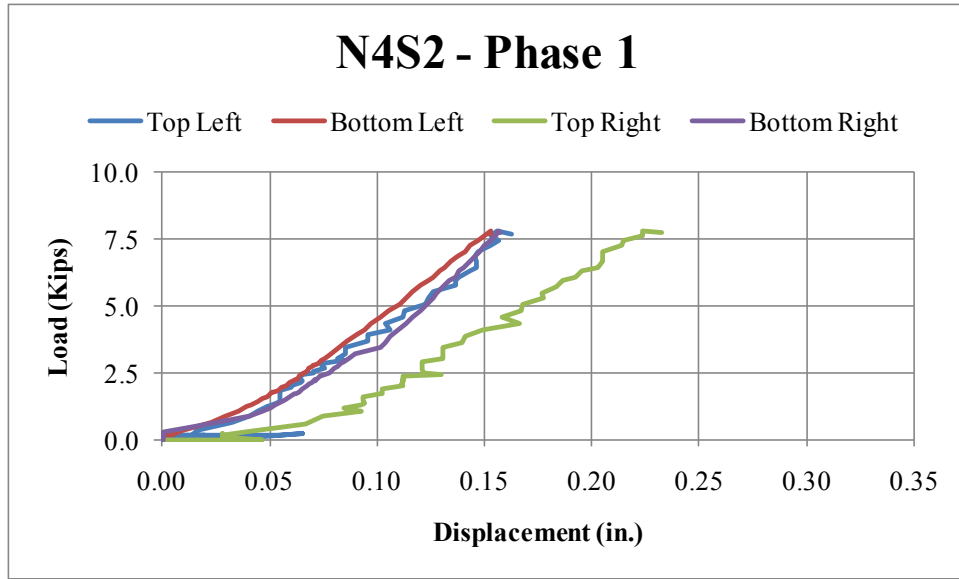




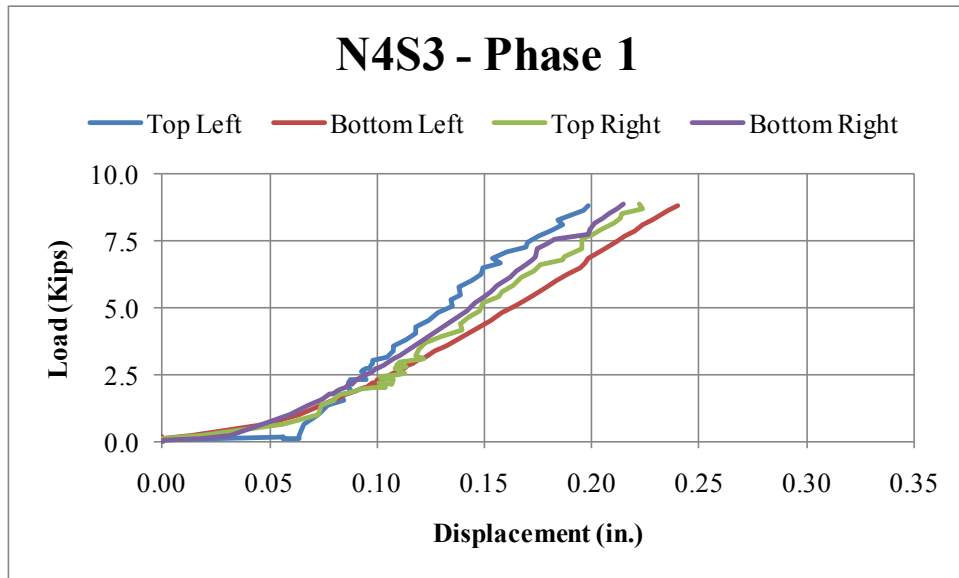
*Figure A.24 Load-displacement response – Specimen N3S6*



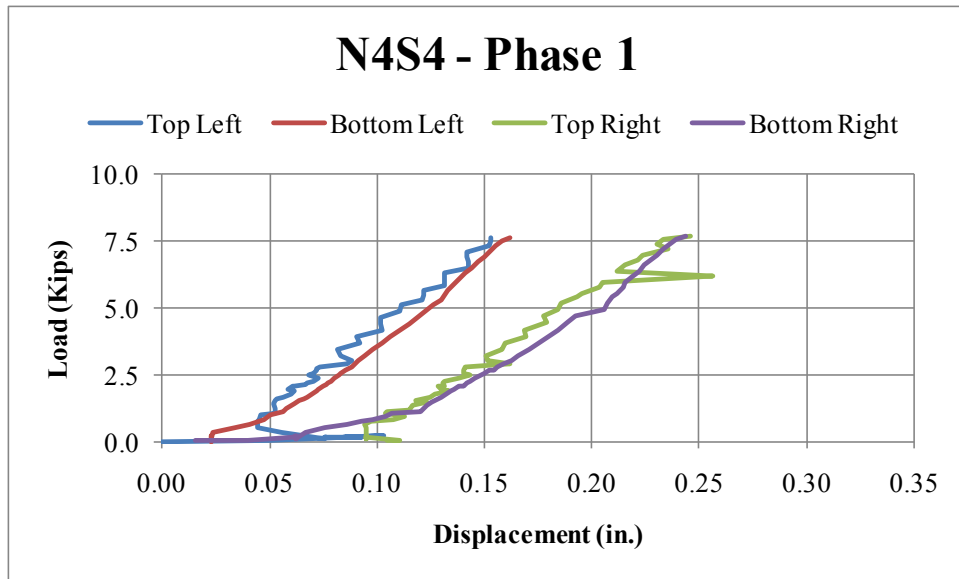
*Figure A.25 Load-displacement response – Specimen N4S1*



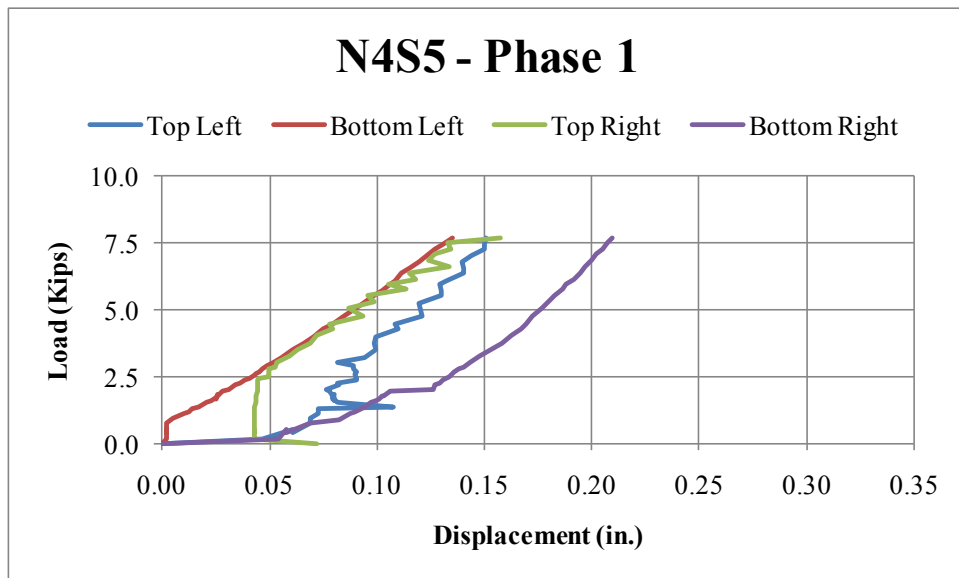
*Figure A.26 Load-displacement response – Specimen N4S2*



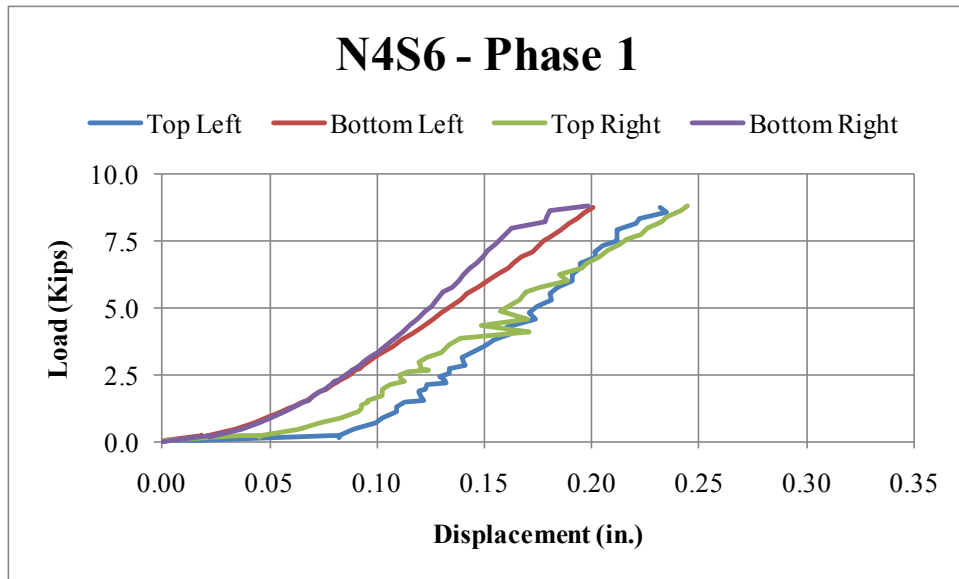
*Figure A.27 Load-displacement response – Specimen N4S3*



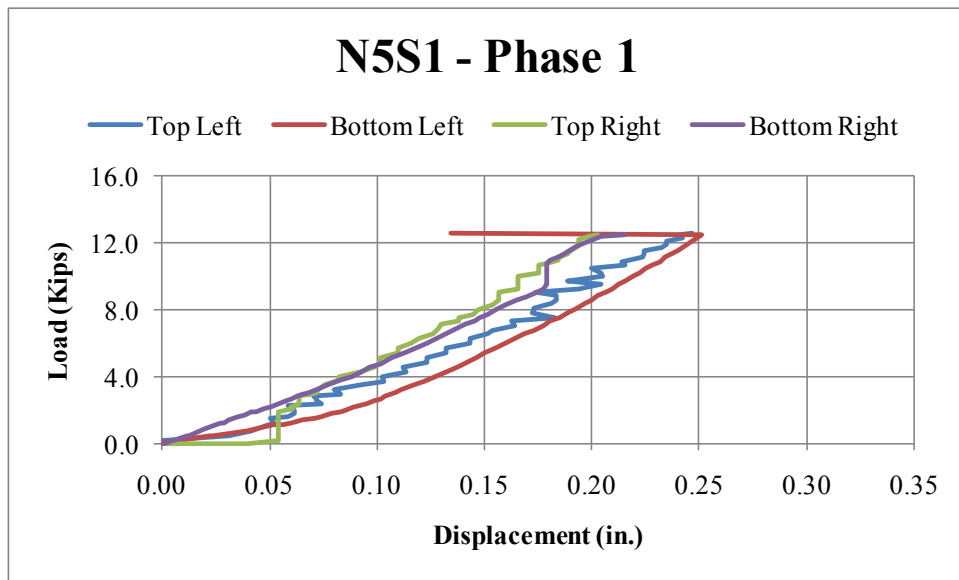
*Figure A.28 Load-displacement response – Specimen N4S4*



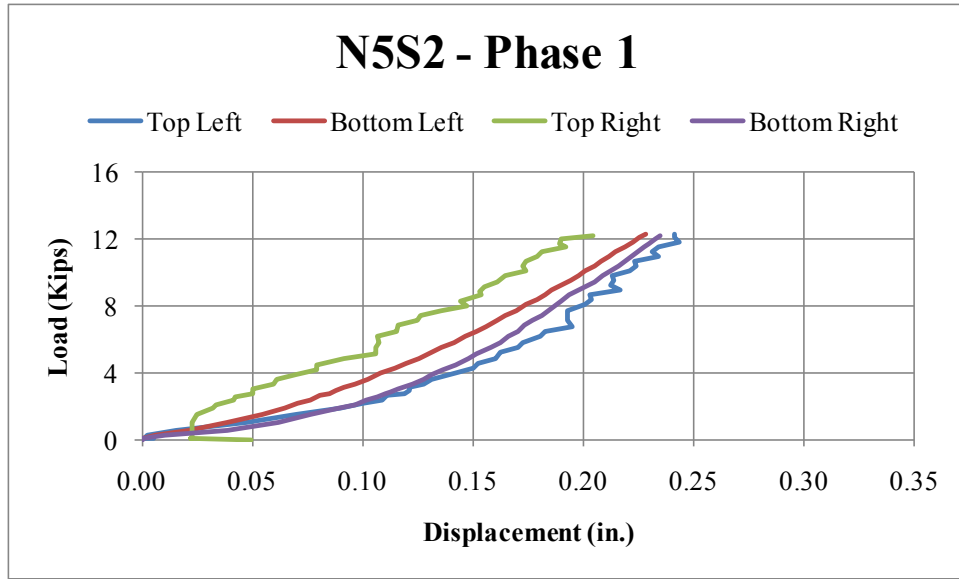
*Figure A.29 Load-displacement response – Specimen N4S5*



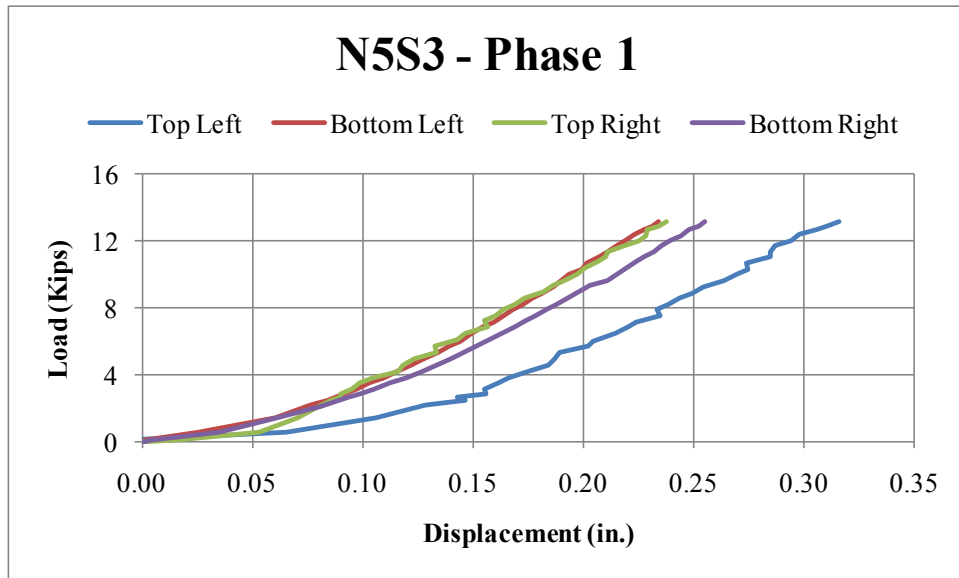
*Figure A.30 Load-displacement response – Specimen N4S6*



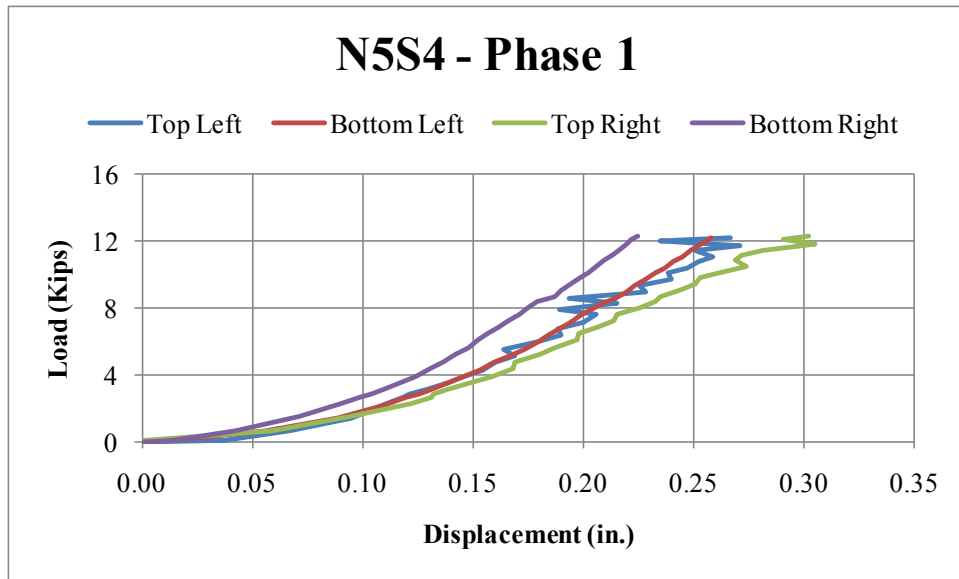
*Figure A.31 Load-displacement response – Specimen N5S1*



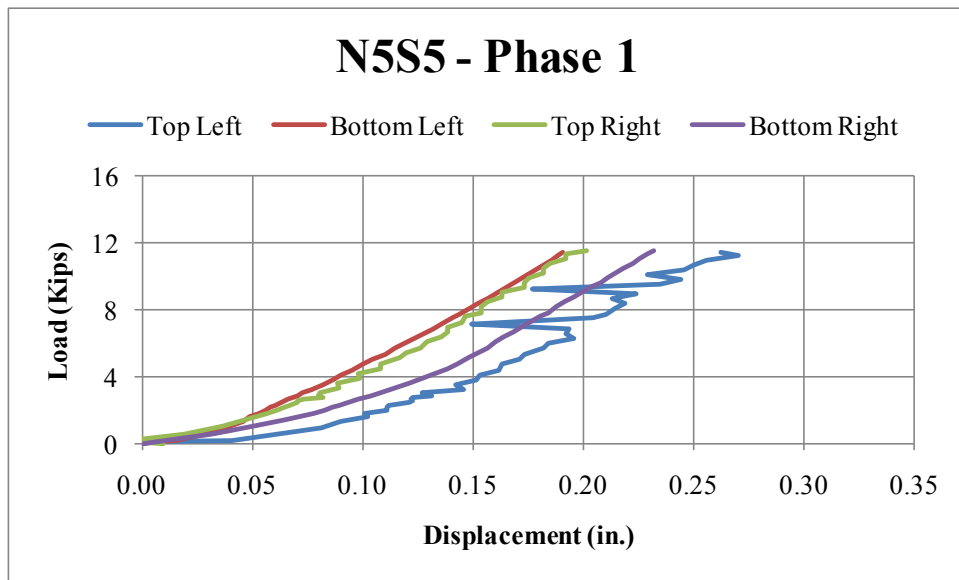
*Figure A.32 Load-displacement response – Specimen N5S2*



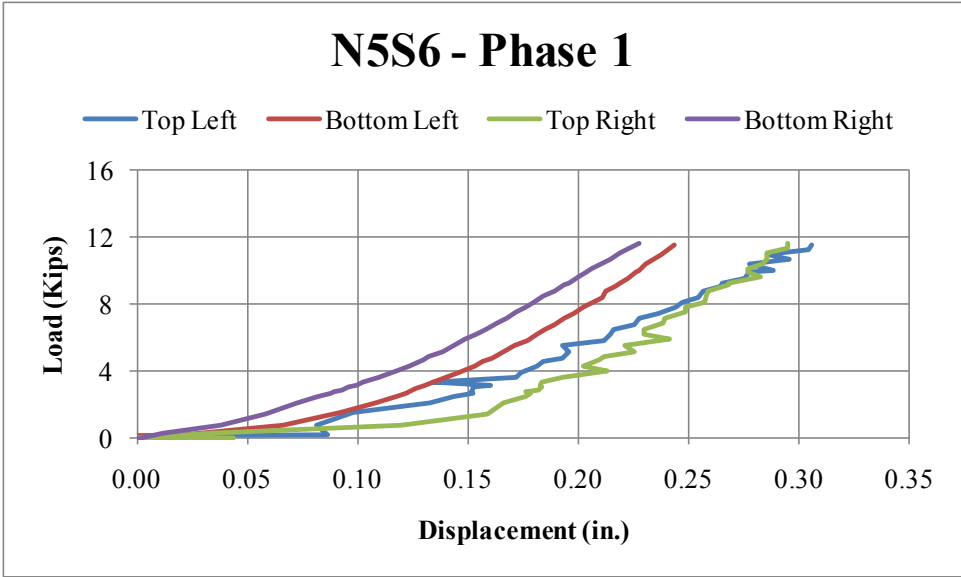
*Figure A.33 Load-displacement response – Specimen N5S3*



*Figure A.34 Load-displacement response – Specimen N5S4*



*Figure A.35 Load-displacement response – Specimen N5S5*



*Figure A.36 Load-displacement response – Specimen N5S6*

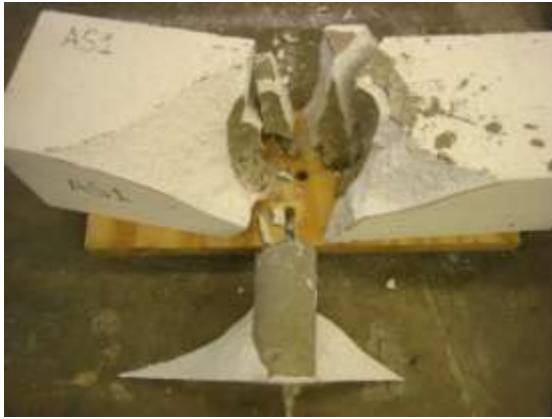
## APPENDIX B

### Pullout Test: Photos and Load-Displacement Responses

#### B.1 INTRODUCTION

A photographic record of the pullout specimens after testing is presented in this Appendix. The load-displacement response of the specimens during the test is also presented here.

#### B.2 PHOTOGRAPHIC RECORD



*Figure B.1 Specimens AS1 (left) and AS2 (right)*



*Figure B.2 Specimens AS3 (left) and AS4 (right)*





*Figure B.3 Specimens AS5 (left) and AS6 (right)*



*Figure B.4 Specimens AS7 (left) and AS8 (right)*



*Figure B.5 Specimens AS9 (left) and AS10 (right)*



*Figure B.6 Specimens AS11 (left) and AS12 (right)*



*Figure B.7 Specimens AS13 (left) and AS14 (right)*

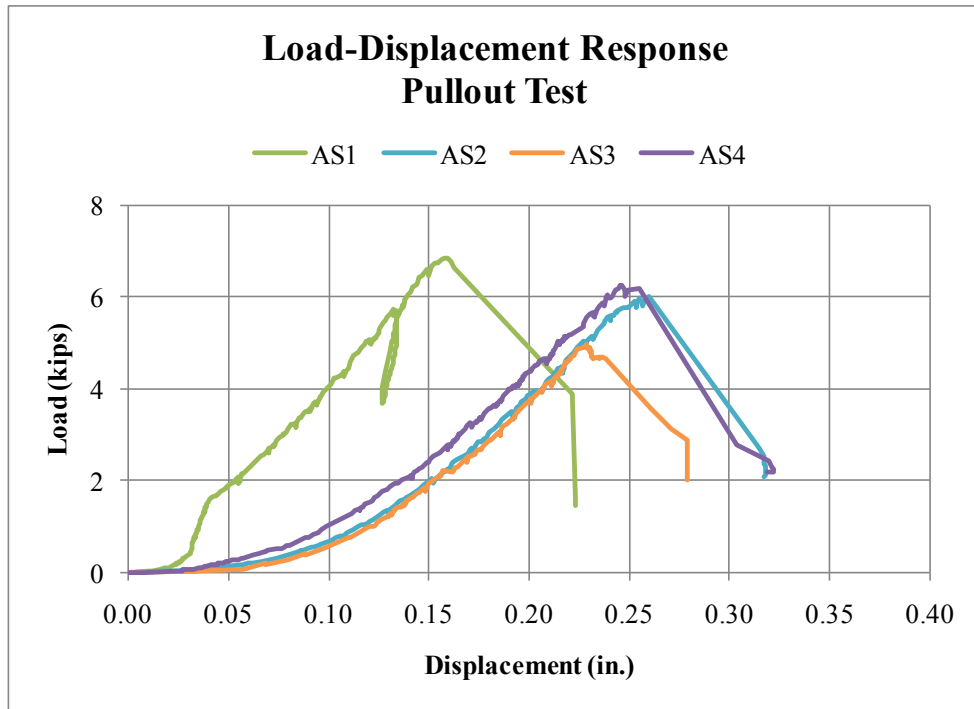


*Figure B.8 Specimens AS15 (left) and AS16 (right)*

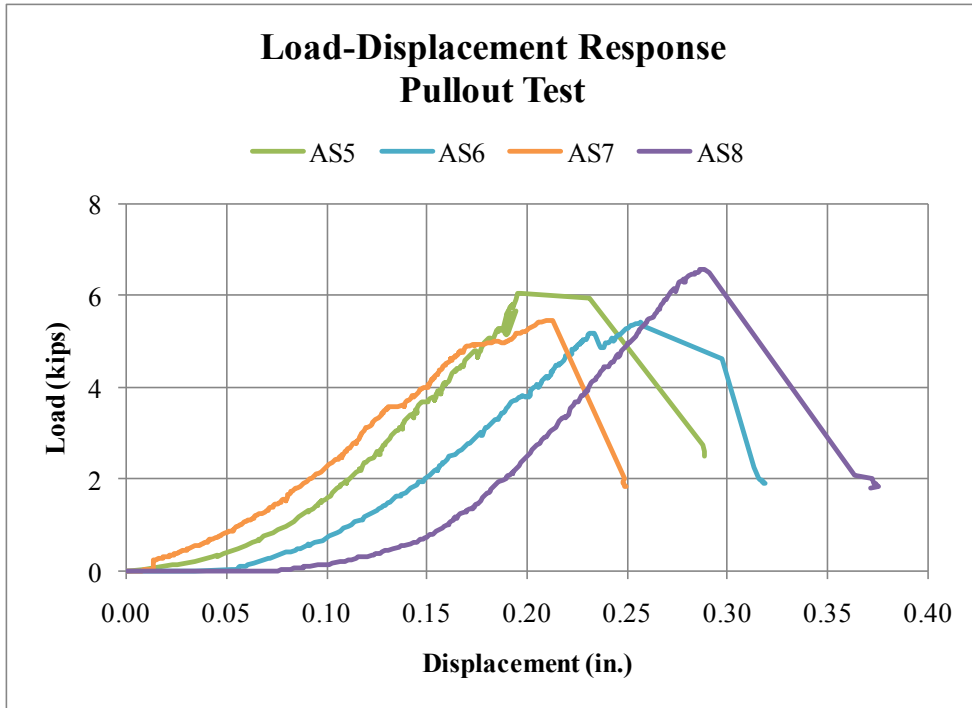


*Figure B.9 Specimens AS17 (left) and AS18 (right)*

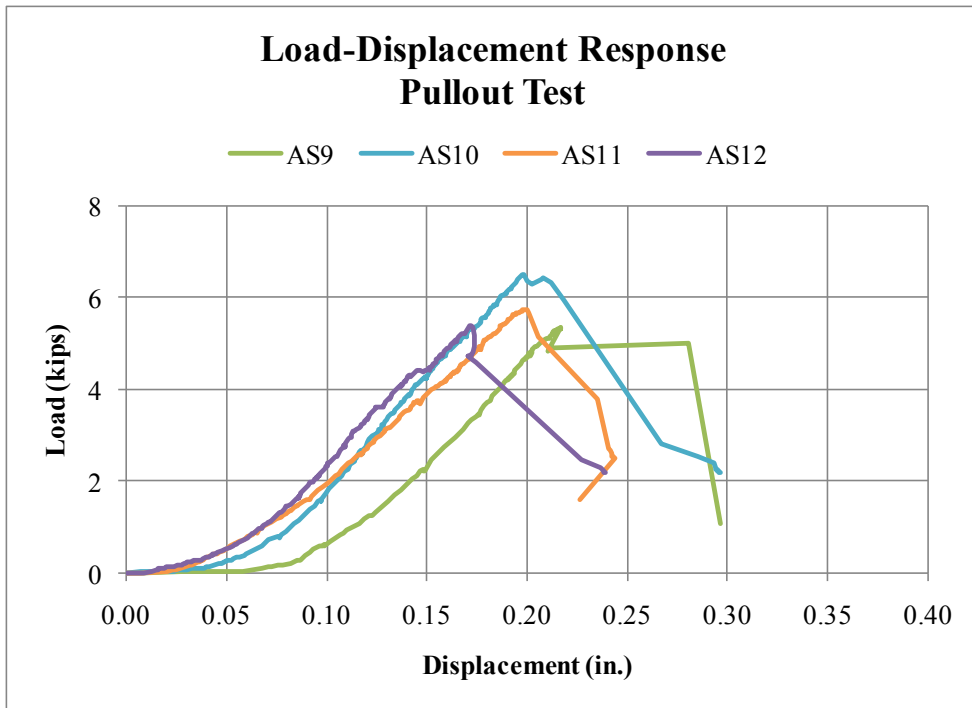
### B.3 LOAD-DISPLACEMENT RESPONSES



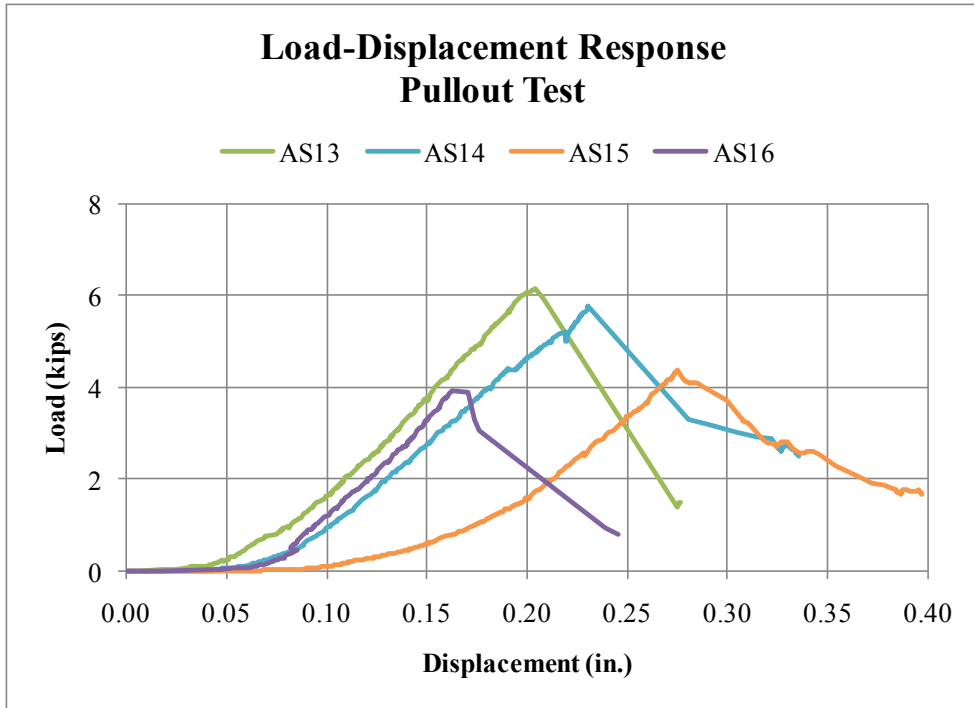
*Figure B.10 Load-displacement response – Specimens AS1 through AS4*



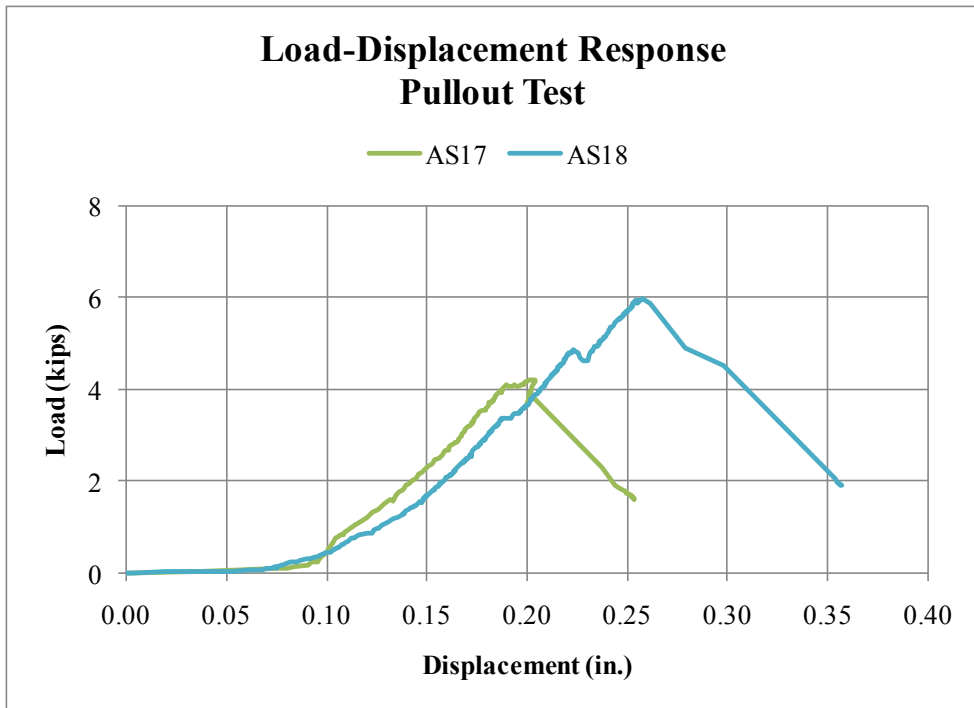
*Figure B.11 Load-displacement response – Specimens AS5 through AS8*



*Figure B.12 Load-displacement response – Specimens AS9 through AS12*



*Figure B.13 Load-displacement response – Specimens AS13 through AS16*



*Figure B.14 Load-displacement response – Specimens AS17 and AS18*

## APPENDIX C

### Material Test Results

#### C.1 INTRODUCTION

Samples of the coarse grout used in the pullout specimens and the lap-splice were tested. The results of the final slump test (ASTM C143-08) and the dimensions of the prisms that were used compressive strength testing (ASTM C1019-09) are presented in this Appendix. Those dimensions were measured after capping the prisms with high-strength gypsum plaster. Two samples of each bar size used in the pullout specimens and the lap-splice specimens were tested by ASTM A370-09a. The resulting stress-strain curves are included here, with the corresponding mill certificates.

#### C.2 GROUT: SLUMP AND DIMENSIONS OF PRISMS

*Table C.1 Slump – Grout*

| Batch | Prisms      | Slump (in.) | Application |             |
|-------|-------------|-------------|-------------|-------------|
|       |             |             | Test        | Specimens   |
| 1     | AP1 - AP6   | 10.75       | Pullout     | AS1 - AS18  |
| 2     | N3P1 - N3P6 | 11.25       | Lap-splice  | N3S1 - N3S6 |
| 3     | N4P1 - N4P6 | 9.75        |             | N4S1 - N4S6 |
| 4     | N5P1 - N5P6 | 10.00       |             | N5S1 - N5S6 |

**Table C.2 Fabrication date and testing age – Grout Prisms**

| Prisms            | Testing Age (days) | Fabrication Date |
|-------------------|--------------------|------------------|
| AP1 through AP3   | 29                 | 14-Oct-09        |
| AP4 through AP6   | 119                |                  |
| N3P1 through N3P3 | 29                 | 12-Jan-10        |
| N3P4 through N3P6 | 86                 |                  |
| N4P1 through N4P3 | 30                 | 25-Feb-10        |
| N4P4 through N4P6 | 45                 |                  |
| N5P1 through N5P3 | 28                 | 11-Mar-10        |
| N5P4 through N5P6 | 35                 |                  |

**Table C.3 Prism height – Grout used in pullout specimens**

| Prism | Capped Height (in.) |        |        |        | Average Height (in.) |           |
|-------|---------------------|--------|--------|--------|----------------------|-----------|
|       | Face 1              | Face 2 | Face 3 | Face 4 | Faces 1-3            | Faces 2-4 |
| AP1   | 8.00                | 8.05   | 8.02   | 8.01   | 8.01                 | 8.03      |
| AP2   | 8.01                | 8.04   | 8.01   | 8.00   | 8.01                 | 8.02      |
| AP3   | 8.08                | 8.13   | 8.13   | 8.09   | 8.10                 | 8.11      |
| AP4   | 8.14                | 8.15   | 8.11   | 8.11   | 8.13                 | 8.13      |
| AP5   | 8.09                | 8.12   | 8.11   | 8.09   | 8.10                 | 8.10      |
| AP6   | 8.27                | 8.31   | 8.31   | 8.27   | 8.29                 | 8.29      |

**Table C.4 Prism width – Grout used in pullout specimens**

| Prism | Width (in.) |        |        |        | Average Width (in.) |           |
|-------|-------------|--------|--------|--------|---------------------|-----------|
|       | Face 1      | Face 2 | Face 3 | Face 4 | Faces 1-3           | Faces 2-4 |
| AP1   | 4.08        | 4.21   | 4.08   | 4.22   | 4.08                | 4.21      |
| AP2   | 4.26        | 4.07   | 4.26   | 4.07   | 4.26                | 4.07      |
| AP3   | 4.09        | 4.12   | 4.10   | 4.12   | 4.10                | 4.12      |
| AP4   | 4.10        | 4.15   | 4.12   | 4.16   | 4.11                | 4.15      |
| AP5   | 4.19        | 4.04   | 4.19   | 4.05   | 4.19                | 4.04      |
| AP6   | 4.11        | 4.10   | 4.10   | 4.12   | 4.11                | 4.11      |

**Table C.5 Prism height – Grout used in lap-splice specimens (No. 3 bars)**

| Prism | Capped Height (in.) |        |        |        | Average Height (in.) |           |
|-------|---------------------|--------|--------|--------|----------------------|-----------|
|       | Face 1              | Face 2 | Face 3 | Face 4 | Faces 1-3            | Faces 2-4 |
| N3P1  | 7.99                | 8.03   | 7.99   | 7.97   | 7.99                 | 8.00      |
| N3P2  | 7.98                | 8.06   | 8.01   | 7.96   | 7.99                 | 8.01      |
| N3P3  | 8.04                | 8.07   | 8.07   | 8.05   | 8.05                 | 8.06      |
| N3P4  | 8.18                | 8.19   | 8.17   | 8.19   | 8.18                 | 8.19      |
| N3P5  | 8.21                | 8.19   | 8.22   | 8.23   | 8.21                 | 8.21      |
| N3P6  | 7.95                | 7.94   | 7.96   | 7.96   | 7.95                 | 7.95      |

**Table C.6 Prism width – Grout used in lap-splice specimens (No. 3 bars)**

| Prism | Width (in.) |        |        |        | Average Width (in.) |           |
|-------|-------------|--------|--------|--------|---------------------|-----------|
|       | Face 1      | Face 2 | Face 3 | Face 4 | Faces 1-3           | Faces 2-4 |
| N3P1  | 4.07        | 4.08   | 4.06   | 4.09   | 4.07                | 4.08      |
| N3P2  | 4.02        | 3.96   | 4.00   | 3.95   | 4.01                | 3.95      |
| N3P3  | 4.06        | 4.13   | 4.06   | 4.12   | 4.06                | 4.13      |
| N3P4  | 4.07        | 4.09   | 4.05   | 4.09   | 4.06                | 4.09      |
| N3P5  | 4.29        | 4.21   | 4.34   | 4.20   | 4.31                | 4.21      |
| N3P6  | 4.06        | 4.09   | 4.04   | 4.08   | 4.05                | 4.09      |

**Table C.7 Prism height – Grout used in lap-splice specimens (No. 4 bars)**

| Prism | Capped Height (in.) |        |        |        | Average Height (in.) |           |
|-------|---------------------|--------|--------|--------|----------------------|-----------|
|       | Face 1              | Face 2 | Face 3 | Face 4 | Faces 1-3            | Faces 2-4 |
| N4P1  | 8.05                | 8.04   | 8.06   | 8.07   | 8.05                 | 8.05      |
| N4P2  | 8.11                | 8.10   | 8.13   | 8.14   | 8.12                 | 8.12      |
| N4P3  | 8.02                | 8.00   | 8.02   | 8.02   | 8.02                 | 8.01      |
| N4P4  | 8.19                | 8.13   | 8.09   | 8.11   | 8.14                 | 8.12      |
| N4P5  | 8.20                | 8.24   | 8.20   | 8.18   | 8.20                 | 8.21      |
| N4P6  | 8.13                | 8.10   | 8.09   | 8.11   | 8.11                 | 8.11      |



**Table C.8 Prism width – Grout used in lap-splice specimens (No. 4 bars)**

| Prism | Width (in.) |        |        |        | Average Width (in.) |           |
|-------|-------------|--------|--------|--------|---------------------|-----------|
|       | Face 1      | Face 2 | Face 3 | Face 4 | Faces 1-3           | Faces 2-4 |
| N4P1  | 4.15        | 4.17   | 4.14   | 4.14   | 4.15                | 4.16      |
| N4P2  | 4.03        | 4.03   | 4.03   | 4.02   | 4.03                | 4.03      |
| N4P3  | 4.08        | 4.03   | 4.09   | 4.04   | 4.09                | 4.03      |
| N4P4  | 4.09        | 4.07   | 4.08   | 4.09   | 4.08                | 4.08      |
| N4P5  | 4.08        | 4.06   | 4.09   | 4.03   | 4.09                | 4.04      |
| N4P6  | 4.10        | 4.04   | 4.12   | 4.05   | 4.11                | 4.04      |

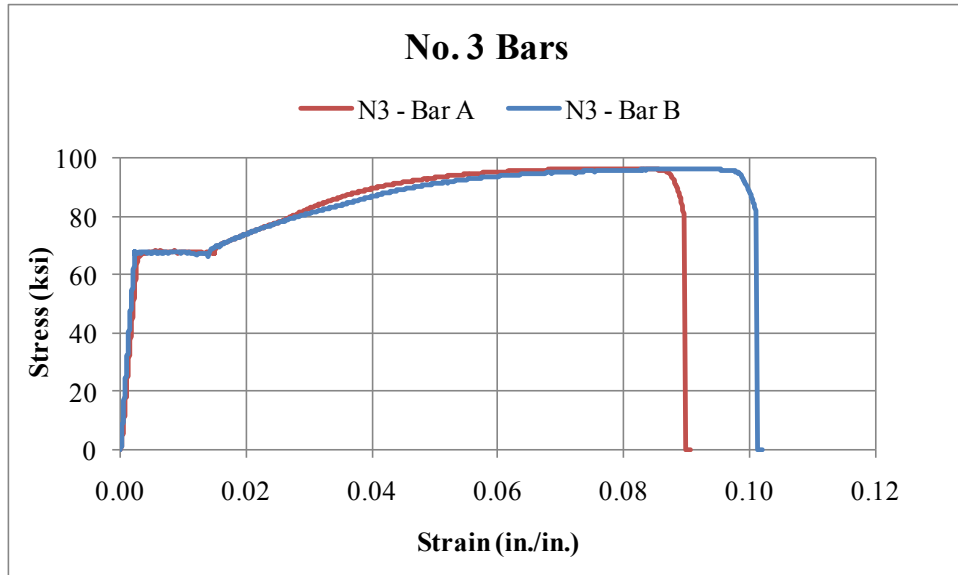
**Table C.9 Prism height – Grout used in lap-splice specimens (No. 5 bars)**

| Prism | Capped Height (in.) |        |        |        | Average Height (in.) |           |
|-------|---------------------|--------|--------|--------|----------------------|-----------|
|       | Face 1              | Face 2 | Face 3 | Face 4 | Faces 1-3            | Faces 2-4 |
| N5P1  | 8.05                | 8.06   | 8.11   | 8.08   | 8.08                 | 8.07      |
| N5P2  | 8.17                | 8.10   | 8.09   | 8.15   | 8.13                 | 8.12      |
| N5P3  | 8.05                | 8.03   | 8.02   | 8.03   | 8.03                 | 8.03      |
| N5P4  | 8.03                | 8.00   | 8.00   | 8.03   | 8.02                 | 8.02      |
| N5P5  | 8.00                | 8.00   | 7.99   | 7.99   | 8.00                 | 7.99      |
| N5P6  | 8.15                | 8.17   | 8.21   | 8.16   | 8.18                 | 8.17      |

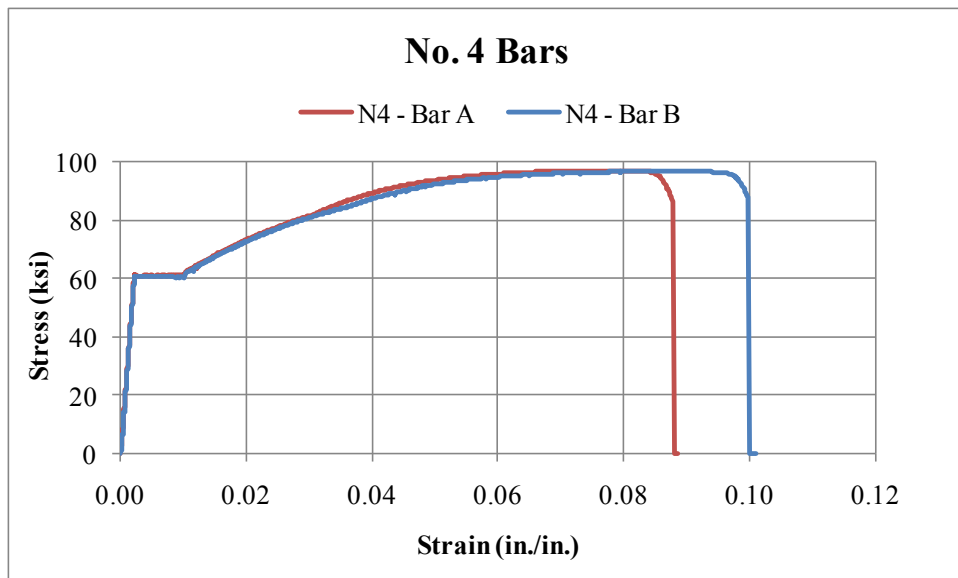
**Table C.10 Prism width – Grout used in lap-splice specimens (No. 5 bars)**

| Prism | Width (in.) |        |        |        | Average Width (in.) |           |
|-------|-------------|--------|--------|--------|---------------------|-----------|
|       | Face 1      | Face 2 | Face 3 | Face 4 | Faces 1-3           | Faces 2-4 |
| N5P1  | 4.03        | 4.09   | 4.04   | 4.06   | 4.04                | 4.08      |
| N5P2  | 3.99        | 4.06   | 4.01   | 3.99   | 4.00                | 4.02      |
| N5P3  | 4.03        | 4.07   | 4.04   | 4.06   | 4.03                | 4.07      |
| N5P4  | 4.08        | 4.00   | 4.08   | 3.99   | 4.08                | 4.00      |
| N5P5  | 4.01        | 4.06   | 4.01   | 4.04   | 4.01                | 4.05      |
| N5P6  | 3.99        | 4.07   | 4.01   | 4.08   | 4.00                | 4.07      |

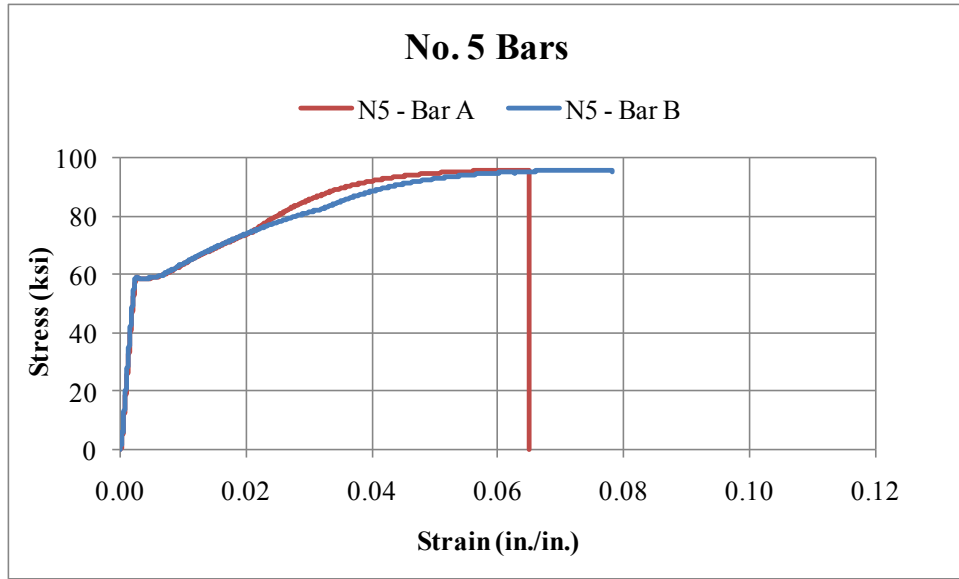
### C.3 REINFORCING STEEL: STRESS-STRAIN CURVES AND MILL CERTIFICATES



*Figure C.1 Stress-strain curve – No. 3 bars*



*Figure C.2 Stress-strain curve – No. 4 bars*



*Figure C.3 Stress-strain curve – No. 5 bars*



CMC STEEL TEXAS  
1 STEEL MILL DRIVE  
REGUIN TX 78155-7510

**CERTIFIED MILL TEST REPORT**  
For additional copies call  
(930)372-8771

We hereby certify that the test results presented here  
are accurate and conform to the reported grade specification

*Daniel J. Schacht*  
Daniel J. Schacht  
Quality Assurance Manager

|   |  |                               |  |                                     |  |                               |  |
|---|--|-------------------------------|--|-------------------------------------|--|-------------------------------|--|
| HEAT NO.: 3008401                         |  | CMC Construction Svcs Houston |  | CMC Construction Svcs Houston South |  | SHIP#: 80129041               |  |
| SECTION: REBAR 10MM (#3) 20'-0"<br>420/60 |  | L 777 N Eldridge Pky. Ste 500 |  | H I 9103 East Alameda Rd            |  | ROL#: 70039498                |  |
| GRADE: ASTM A615-08B Gr 420/60            |  | D HOUSTON TX                  |  | P Houston TX                        |  | CUST PO#: 8350                |  |
| ROLL DATE: 03/04/2009                     |  | T US 77079-4524               |  | US 77054-4502                       |  | CUST PIN:                     |  |
| MELT DATE:                                |  | O 713 799 1150                |  | T 7137991150                        |  | POUNDS PER HEAT: 23166.000 LB |  |
|   |  |                               |  |                                     |  | PIECES PER HEAT: 3681 EA      |  |

| Characteristic              | Value    | Characteristic     | Value   |
|-----------------------------|----------|--------------------|---------|
| C                           | 0.43%    | Bend Test Diameter | 1.313IN |
| Mn                          | 0.71%    | Bend Test          | Passed  |
| P                           | 0.012%   |                    |         |
| S                           | 0.031%   |                    |         |
| Si                          | 0.18%    |                    |         |
| Cu                          | 0.26%    |                    |         |
| Cr                          | 0.18%    |                    |         |
| Fe                          | 0.14%    |                    |         |
| Mo                          | 0.051%   |                    |         |
| V                           | 0.001%   |                    |         |
| Ch                          | 0.003%   |                    |         |
| Sn                          | 0.013%   |                    |         |
| Al                          | 0.002%   |                    |         |
| B                           | 0.0003%  |                    |         |
| Ti                          | 0.001%   |                    |         |
| Yield Strength test 1       | 73.1ksi  |                    |         |
| Tensile Strength test 1     | 111.7ksi |                    |         |
| Elongation test 1           | 14%      |                    |         |
| Elongation Gage Lgth test 1 | 8IN      |                    |         |

THIS MATERIAL IS FULLY KILLED, 100% MELTED AND MANUFACTURED IN THE USA, WITH NO WELD REPAIR OR MERCURY CONTAMINATION IN THE PROCESS.

REMARKS:

Figure C.4 Mill certificate – No. 3 bars



CMC STEEL TEXAS  
1 STEEL MILL DRIVE  
SEGUIN TX 78155-7510

**CERTIFIED MILL TEST REPORT**  
For additional copies call  
(830)372-8771

Our history verify that our test results presented here  
are accurate and confirm to the reported grade specifications!

*Denis J. Schlauch*  
Denis J. Schlauch  
Quality Assurance Manager

|                                |   |                                  |                              |
|--------------------------------|---|----------------------------------|------------------------------|
| HEAT NO.: 3008317              | S | CMC Construction Svcs Houston SW | SHIPS: 80130317              |
| SECTION: REBAR 13MM (#4) 20'0" | H | 9103 E Almeida Rd                | BOL#: 70039958               |
| 420/60                         | I | Houston TX                       | CUST PO#: 83B-G              |
| GRADE: ASTM A615-06b Gr 420/60 | P | US 77054-4502                    | CUST P/N:                    |
| ROLL DATE: 02/26/2009          | T | 713 799 1150                     | POUNDS PER HEAT: 4356,000 LB |
| MELT DATE:                     | O |                                  | PIECES PER HEAT: 326 EA      |

| Characteristic              | Value    | Characteristic     | Value   | Characteristic | Value |
|-----------------------------|----------|--------------------|---------|----------------|-------|
| C                           | 0.43%    | Bend Test Diameter | 1.750IN |                |       |
| Mn                          | 0.74%    | Bend Test          | Passed  |                |       |
| P                           | 0.013%   |                    |         |                |       |
| S                           | 0.025%   |                    |         |                |       |
| Si                          | 0.18%    |                    |         |                |       |
| Cu                          | 0.30%    |                    |         |                |       |
| Cr                          | 0.17%    |                    |         |                |       |
| Ni                          | 0.15%    |                    |         |                |       |
| Mo                          | 0.022%   |                    |         |                |       |
| V                           | 0.001%   |                    |         |                |       |
| Ca                          | 0.002%   |                    |         |                |       |
| Sn                          | 0.000%   |                    |         |                |       |
| Al                          | 0.002%   |                    |         |                |       |
| B                           | 0.0000%  |                    |         |                |       |
| Ti                          | 0.001%   |                    |         |                |       |
| Yield Strength test 1       | 62.2ksi  |                    |         |                |       |
| Tensile Strength test 1     | 100.5ksi |                    |         |                |       |
| Elongation test 1           | 16%      |                    |         |                |       |
| Elongation Gage Lgth test 1 | 8IN      |                    |         |                |       |

REMARKS: THIS MATERIAL IS FULLY KILLED, 100% MELTED AND MANUFACTURED IN THE USA, WITH NO WELD REPAIR OR MERCURY CONTAMINATION IN THE PROCESS.

Figure C.5 Mill certificate – No. 4 bars



CMC STEEL TEXAS  
1 STEEL MILL DRIVE  
SEGUIN TX 78155-7810

**CERTIFIED MILL TEST REPORT**  
For additional copies call  
(830)372-8771

Our mercury content test results presented here  
are accurate and conform to the reported grade specification

*Daniel J. Schacht*  
Daniel J. Schacht  
Quality Assurance Manager

| HEAT NO.: 3009020                   |         | SHIP#: 80130343                     |         |
|-------------------------------------|---------|-------------------------------------|---------|
| SECTION: REBAR 16MM (#5) 20'0"      |         | BOL#: 70039914                      |         |
| 420/80                              |         | CUST PO#: 835-G                     |         |
| GRADE: ASTM-A615-66E Gr 420/80      |         | CUST P/N:                           |         |
| ROLL DATE: 04/06/2009               |         | POUNDS PER HEAT: 6570.000 LB        |         |
| MELT DATE:                          |         | PIECES PER HEAT: 315 EA             |         |
| S. CMC Construction Svcs Houston SW |         | S. CMC Construction Svcs Houston SW |         |
| L. 9103 E Alameda Rd                |         | I. 9103 E Alameda Rd                |         |
| D. Houston TX                       |         | P. Houston TX                       |         |
| T. US 77054-4502                    |         | T. US 77054-4502                    |         |
| D. 713 789 1150                     |         | O. 713 789 1150                     |         |
| Characteristic                      |         | Characteristic                      |         |
| Value                               |         | Value                               |         |
| C                                   | 0.38%   | Bend Test Diameter                  | 2.188IN |
| Mn                                  | 0.98%   | Bend Test                           | Passed  |
| P                                   | 0.014%  |                                     |         |
| S                                   | 0.031%  |                                     |         |
| Si                                  | 0.24%   |                                     |         |
| Cu                                  | 0.34%   |                                     |         |
| Cr                                  | 0.16%   |                                     |         |
| Ni                                  | 0.17%   |                                     |         |
| Mg                                  | 0.058%  |                                     |         |
| V                                   | 0.003%  |                                     |         |
| Ca                                  | 0.000%  |                                     |         |
| Sr                                  | 0.015%  |                                     |         |
| Al                                  | 0.000%  |                                     |         |
| B                                   | 0.0010% |                                     |         |
| Ti                                  | 0.002%  |                                     |         |
| Yield Strength test 1               | 62.1ksi |                                     |         |
| Tensile Strength test 1             | 99.4ksi |                                     |         |
| Elongation test 1                   | 14%     |                                     |         |
| Elongation Gauge Length test 1      | 8IN     |                                     |         |

THIS MATERIAL IS FULLY KILLED, 100% MELTED AND MANUFACTURED IN THE USA, WITH NO WELD REPAIR OR MERCURY CONTAMINATION IN THE PROCESS.

Figure C.6 Mill certificate – No. 5 bars

## REFERENCES

- ASTM A370-09a: *Standard Test Methods and Definitions for Mechanical Testing of Steel Products*, American Society for Testing and Materials, West Conshohocken, PA, 2009.
- ASTM A615-09: *Standard Specification for Deformed and Plain Carbon-Steel Bars for Concrete Reinforcement*, American Society for Testing and Materials, West Conshohocken, PA, 2009.
- ASTM A1034-05b: *Standard Test Methods for Testing Mechanical Splices for Steel Reinforcing Bars*, American Society for Testing and Materials, West Conshohocken, PA, 2005.
- ASTM C143-08: *Standard Test Method for Slump of Hydraulic-Cement Concrete*, American Society for Testing and Materials, West Conshohocken, PA, 2008.
- ASTM C476-09: *Standard Specification for Grout for Masonry*, American Society for Testing and Materials, West Conshohocken, PA, 2009.
- ASTM C1019-09: *Standard Test Method for Sampling and Testing Grout*, American Society for Testing and Materials, West Conshohocken, PA, 2009.
- Hammons *et al.* 1994: Hammons, M.I., Atkinson, R.H., Schuller, M.P., Tikalsky, P.J., “Masonry Research for Limit-States Design,” Construction Productivity Advancement Research Program Technical Report, CPAR-SL-94-1, October, 1994.

Kingsley *et al.* 1985: Kingsley, G. R., Tulin, L. G. and Noland, J. L., “The Influence of Water Content and Unit Absorption Properties on Grout Compressive Strength and Bond Strength in Hollow Clay Unit Masonry,” *Proceedings*, Third North American Masonry Conference, Arlington, Texas, 1985.

MSJC 2008a: Masonry Standards Joint Committee, *Building Code Requirements for Masonry Structures (TMS 402-08 / ACI 530-08 / ASCE 5-08)*, The Masonry Society, Boulder, Colorado, the American Concrete Institute, Farmington Hills, Michigan, and the American Society of Civil Engineers, Reston, Virginia, 2008.

MSJC 2008b: Masonry Standards Joint Committee, *Specification for Masonry Structures (TMS 602-08 / ACI 530.1-08 / ASCE 6-08)*, The Masonry Society, Boulder, Colorado, the American Concrete Institute, Farmington Hills, Michigan, and the American Society of Civil Engineers, Reston, Virginia, 2008.

MSJC 2008c: Masonry Standards Joint Committee, *Commentary on Building Code Requirements for Masonry Structures (TMS 402-08 / ACI 530-08 / ASCE 5-08)*, The Masonry Society, Boulder, Colorado, the American Concrete Institute, Farmington Hills, Michigan, and the American Society of Civil Engineers, Reston, Virginia, 2008.

NCMA 1999: National Concrete Masonry Association, “Evaluation of Reinforcing Bar Splice Criteria for Hollow Clay Brick and Hollow Concrete Block Masonry,” Herndon, Virginia, May, 1999.

Natrella 1963: Natrella, Mary G., *Experimental Statistics*, National Bureau of Standards (NBS) Handbook 91, U.S. Department of Commerce, Washington, DC, 1963.



Tanner 2003: Tanner, Jennifer E., "Design Provisions for Autoclaved Aerated Concrete (AAC) Structural Systems," PhD Dissertation, Department of Civil Engineering, the University of Texas at Austin, May, 2003.

Thompson 1997: Thompson, J.J., "Behavior and Design of Tension Lap Splices in Reinforced Concrete Masonry," Masters Thesis, Department of Civil and Environmental Engineering, Washington State University, Pullman, Washington, 1997.

UBC 1997: International Conference of Building Officials (ICBC), *1997 Uniform Building*, Whittier, California, 1997.

## VITA

Miguel Forero Henao was born in Bogotá, Colombia, on April 24, 1979, the son of Jaime Forero Castrillón and María Ana Henao de Brigard, the brother of María Carolina and Santiago. After living in Barranquilla and in El Cerrejón during his childhood, he moved with his family back to Bogotá and attended the Colegio San Carlos, where he received his high school diploma in June 1996. He went on to study in the Pontificia Universidad Javeriana, where he obtained the degree of Civil Engineer in April 2002. During his studies, he did a six-month internship in a local structural engineering firm. Upon graduation, he worked for a year in the Civil Engineering Department of the same school that he had attended. He then took a position with Suncoast Post-Tension, Ltd., Miami, Florida as a Project Engineer, where he worked for four years starting on June 2003. He married Olga Lucía Almanza in July 2004. He transferred to the Houston office of Suncoast Post-Tension, where he worked for a year prior to enrolling in the Graduate School of The University of Texas at Austin in August of 2008. He has recently rejoined that office.

Permanent Address: 12330 N Gessner Dr, Apt. 1027  
Houston, Texas 77064

This thesis was typed by the author.