

1. Report No. FHWA/TX-88+481-2		2. Government Accession No.		3. Recipient's Catalog No.	
4. Title and Subtitle THE EFFECT OF FLY ASH ON THE TEMPERATURE RISE IN CONCRETE				5. Report Date February 1988	
				6. Performing Organization Code	
7. Author(s) Richard S. Barrow and Ramon L. Carrasquillo				8. Performing Organization Report No. Research Report 481-2	
9. Performing Organization Name and Address Center for Transportation Research The University of Texas at Austin Austin, Texas 78712-1075				10. Work Unit No.	
				11. Contract or Grant No. Research Study 3-5/9-87-481	
12. Sponsoring Agency Name and Address Texas State Department of Highways and Public Transportation; Transportation Planning Division P. O. Box 5051 Austin, Texas 78763-5051				13. Type of Report and Period Covered Interim	
				14. Sponsoring Agency Code	
15. Supplementary Notes Study conducted in cooperation with the U. S. Department of Transportation, Federal Highway Administration Research Study Title: "Durability and Performance of Concrete Containing Fly Ash"					
16. Abstract <p>One of the most serious problems facing the concrete industry in Texas is the effect of high temperatures in concrete on concrete performance. Hot weather and the hydration of cement produce high temperature conditions. One of the major problems associated with high temperatures in concrete is the potential for thermal cracking. The temperature rise can be lowered through the use of mineral admixtures such as fly ash. This report is the first in a comprehensive study which addresses the effect of fly ash on the temperature rise in concrete and the thermal gradient in concrete resulting from the hydration of cement.</p> <p>This report presents the results from a research program in which the temperature rise in mortar samples and the thermal gradient in concrete are examined. Other tests were conducted to monitor the thermal gradient along the vertical cross section of concrete members having various dimensions, curing conditions, and mix proportions.</p> <p>The results of this study show that the replacement of cement with Type A fly ash results in a reduction in the temperature rise in concrete, whereas replacement of cement with Type B fly ash has no significant effect on the temperature rise in concrete. The results also show that the thermal gradient is not linear through the depth of a concrete member from mid-depth to the exposed concrete surface. Most of the temperature drop within a concrete member occurs near the exposed concrete surface. The project engineer is provided with guidelines to produce more durable concrete structures by reducing the internal concrete temperature, thus reducing the potential for thermal cracking.</p>					
17. Key Words concrete, temperatures, thermal cracking, thermal gradient, hydration, cement, curing conditions, mix proportions, durability, potential			18. Distribution Statement No restrictions. This document is available to the public through the National Technical Information Service, Springfield, Virginia 22161.		
19. Security Classif. (of this report) Unclassified		20. Security Classif. (of this page) Unclassified		21. No. of Pages 198	22. Price

THE EFFECT OF FLY ASH ON THE TEMPERATURE RISE IN CONCRETE

by

Richard S. Barrow
and
Ramon L. Carrasquillo

Research Report Number 481-2

Research Project 3-5/9-87-481

"Durability and Performance of Concrete Containing Fly Ash"

Conducted for

Texas

State Department of Highways and Public Transportation

In Cooperation with the
U.S. Department of Transportation
Federal Highway Administration

by

CENTER FOR TRANSPORTATION RESEARCH
BUREAU OF ENGINEERING RESEARCH
THE UNIVERSITY OF TEXAS AT AUSTIN

February 1988

The contents of this report reflect the views of the authors who are responsible for the facts and accuracy of the data presented herein. The contents do not necessarily reflect the official views or policies of the Federal Highway Administration. This reports does not constitute a standard, specification, or regulation.

PREFACE

This is the second in a series of reports summarizing the durability and performance of concrete containing fly ash. The first report addressed the sulfate resistance of concrete containing fly ash. This report summarizes the effect of the partial replacement of cement with fly ash on the temperature rise in concrete. Other reports in this series will address the topics of sealing resistance, abrasion resistance, freeze-thaw durability, creep and shrinkage at early ages, and fly ash characterization.

This is part of Research Project 3-5/9-87-481, entitled "Durability and Performance of Concrete Containing Fly Ash". The study described in this report was jointly conducted by the Center for Transportation Research, Bureau of Engineering Research and the Phil M. Ferguson Structural Engineering Laboratory at the University of Texas at Austin. The work was co-sponsored by the Texas State Department of Highways and Public Transportation and The Federal Highway Administration.

The overall study was directed and supervised by Dr. Ramon L. Carrasquillo.

SUMMARY

One of the most serious problems facing the concrete industry in Texas is the effect of high temperatures in concrete on concrete performance. Hot weather and the hydration of cement produce high temperature conditions. One of the major problems associated with high temperatures in concrete is the potential for thermal cracking.

The temperature rise in concrete in the field can be lowered through the use of mineral admixtures such as fly ash. This report is the first in a comprehensive study which addresses the effect of fly ash on the temperature rise in concrete and the thermal gradient in concrete resulting from the hydration of cement.

This report presents the results from a research program in which the temperature rise in mortar samples and the thermal gradient in concrete are examined. In the tests conducted to monitor the temperature rise in mortar, TSDHPT Type A and Type B fly ashes were used as a partial replacement of Type I, Type I- II, and Type III cements. The percent replacements of cement by fly ash were 0, 20, 27.5, and 35 percent by volume. Other tests were conducted to monitor the thermal gradient along the vertical cross section of concrete members having various dimensions, curing conditions, and mix proportions.

The results of this study show that the replacement of cement with Type A fly ash results in a reduction in the temperature rise in concrete, whereas replacement of cement with Type B fly ash has no significant effect on the temperature rise in concrete. The results also show that the thermal gradient is not linear through the depth of a concrete member from mid-depth to the exposed concrete surface. Most of the temperature drop within a concrete member occurs near the exposed concrete surface. The project engineer is provided with guidelines to produce more durable concrete structures by reducing the internal concrete temperature, thus reducing the potential for thermal cracking.

IMPLEMENTATION

The information in this report constitutes the first step in the development of the information needed to aid resident engineers in the proper selection and use of fly ash to reduce the temperature rise in concrete due to hydration.

The results from this study provide recommendations in the selection of fly ash as a partial replacement for cement to reduce the potential for thermal cracking in concrete.

TABLE OF CONTENTS

Chapter	Page
1 INTRODUCTION	
1.1 General	1
1.2 Problem Statement	1
1.3 Definition of Fly Ash	3
1.4 Coal	3
1.5 Fly Ash Classification	4
1.6 Research Objectives	6
1.7 Report Format	6
2 CHEMISTRY OF THE HYDRATION OF PORTLAND CEMENT AND FLY ASH	
2.1 General	7
2.2 Hydration of Silicates	7
2.3 Hydration of Aluminates and Ferrites	10
2.4 Effect of W/C Ratio on the Hydration of Cement	12
2.5 Reaction of Cement and Fly Ash	12
2.6 Pozzolanic Reaction	15
2.7 Finely Divided Powder Effect	15
2.8 Effect of Particle Size on Hydration	19
3 THE EFFECT OF FLY ASH ON THE PROPERTIES OF CONCRETE: A LITERATURE REVIEW	
3.1 Introduction	21
3.2 Temperature Rise in Concrete	21
3.3 Strength of Fly Ash Concrete	35

3.4	Workability of Fly Ash Concrete	35
3.5	The Effect of Chemical Admixtures on the Hydration of Cement	39
3.5.1	Water Reducers/Retarders	39
3.5.2	Superplasticizers	40
4	EXPERIMENTAL WORK	
4.1	Introduction	45
4.2	Temperature Gradient Tests	45
4.2.1	Test Equipment	45
4.2.2	Test 1	46
4.2.3	Test 2	46
4.2.4	Test 3	46
4.2.5	Test 4	48
4.3	Temperature Rise in Mortar Samples	51
4.3.1	Test Setup	51
4.3.2	Materials	51
4.3.3	Mortar Mix Proportions	53
4.3.4	Mixing Procedure	54
4.4	Compressive Tests for Mortar	55
4.5	Flow Tests for Mortar	55
5	TEST RESULTS	
5.1	Introduction	57
5.2	Data Reduction	57
5.2.1	Temperature Rise	57
5.2.2	Peak Temperature	57
5.2.3	Time to Peak Temperature	58

5.3 Thermal Gradients	58
5.4 Temperature Rise in Mortar	59
5.4.1 Test Parameters	59
5.4.1.1 Correlation of Samples to Mass Concrete	59
5.4.1.2 Ambient Temperature	72
5.4.1.3 Initial Mix Temperature	72
5.4.1.4 Cement Type and Content	72
5.4.1.5 Water to Cementitious Materials Ratio	77
5.4.2 Temperature Rise Profiles	77
5.4.2.1 Peak Temperature	98
5.4.2.2 Time to Peak Temperature	98
5.5 Strength	98
5.6 Flow	112
6 DISCUSSION OF TEST RESULTS	
6.1 Introduction	115
6.2 Thermal Gradient	115
6.3 Test Parameters	116
6.3.1 Correlation of Samples to Mass Concrete	116
6.3.2 Ambient Temperature	116
6.3.3 Initial Mix Temperature	116
6.3.4 Cement Type and Content	117
6.3.5 Water to Cementitious Materials Ratio	117
6.4 The Effect of Fly Ash on the Temperature	118
6.4.1 Peak Temperature	118
6.4.2 Time to Peak Temperature	118
6.5 Strength	122

6.6 Flow	131
7 DISCUSSION OF TEST RESULTS FOR MIXES CONTAINING CHEMICAL ADMIXTURE	
7.1 Introduction	133
7.2 The Effect of Chemical Admixture Addition on the Temperature Rise in Mortar	133
7.2.1 Peak Temperature	133
7.2.2 Time to Peak Temperature	136
7.3 Strength	141
7.4 Flow	141
8 SUMMARY, CONCLUSIONS, AND RECOMMENDATIONS	
8.1 Summary	145
8.2 Conclusions	146
8.2.1 Temperature Tests	146
8.2.2 Strength	147
8.2.3 Flow	147
8.3 Guidelines	148
8.4 Recommendations for Future Research	148
APPENDIX A	151
APPENDIX B	165
REFERENCES	175

LIST OF FIGURES

Figure	Page	
1.1	Effect of concrete temperature, air temperature, relative humidity, and wind velocity on the rate of evaporation of surface moisture from concrete [4]	2
2.1	Rate of heat evolution during the hydration of tricalcium silicate [8]	8
2.2	Rate of heat evolution during the hydration of tricalcium aluminate with gypsum [8]	8
2.3	Rate of heat evolution during the hydration of Portland cement [8]	13
2.4	Ettringite Production vs. Hydration Time for ordinary Portland cement [11]	14
2.5	Typical rates of strength increase for plain concrete and fly ash concrete proportioned by simple replacement [3]	16
2.6	Portlandite content per unit weight of ordinary Portland cement (OPC) vs. age of hydration [13]	17
2.7	Cube strengths of concretes with and without mineral admixture as a function of the water to cementitious materials ratio [14]	18
2.8	Compositional tendencies of Texas fly ashes based on statistical analysis [15]	20
3.1	Vertical temperature gradient recorded at the time of maximum temperature rise in fly ash, slag, and plain concrete foundation units [17]	24
3.2	Relationship between strain and temperature recorded at mid-depth of concrete foundations [17]	25
3.3	Degree of tensile restraint at center of section [18]	26
3.4	Isothermic curves in deg. C for horizontal section of a concrete buttress head for various ages [20]	28
3.5	Graphical determination of safe concrete form stripping temperature [21]	30
3.6	Adiabatic temperature rise in concrete containing high calcium fly ash [3]	32
3.7	Number of cracks per 30m of day's work vs. maximum air temperature during construction of a concrete road [23]	33
3.8	Compressive strength development of concretes containing high calcium fly ash [3]	34
3.9	Water reduction in mortar vs. fly ash replacement of Portland cement in mortar [30]	37

3.10	Heat evolution curves of Portland cement and fly ash [32]	41
3.11	Heat evolution curves of Portland cement and fly ash, with lignosulfonate addition [32]	41
3.12	Dispersing action of superplasticizer (schematic representation): a) flocculated paste; b) dispersed paste [8]	42
4.1	Dimensions and thermocouple locations for samples used in Test 1 and Test 2	47
4.2	Dimensions and thermocouple locations for the samples used in Test 3	49
4.3	Dimensions and thermocouple locations for the samples used in Test 4	50
4.4	Mortar sample insulated by polyurethane foam	52
5.1	Temperature profile for Test 1	60
5.2	Maximum vertical temperature gradient for Test 1	61
5.3	Temperature profile for Test 2	62
5.4	Maximum vertical temperature gradient for Test 2	63
5.5	Temperature profile for Test 3 sample with top surface exposed	64
5.6	Temperature profile for Test 3 sample with top surface covered with damp burlap and plastic	65
5.7	Maximum vertical temperature gradients for Test 3 samples	66
5.8	Temperature profile for Test 4 sample with top surface exposed	67
5.9	Temperature profile for Test 4 sample with top surface covered with damp burlap and plastic	68
5.10	Maximum vertical temperature gradients for Test 4 samples	69
5.11	Comparison of temperature rise in Test 1 sample to insulated sample	70
5.12	Comparison of temperature rise in Test 2 sample to insulated sample	71
5.13	Effect of ambient temperature on the temperature rise in mortar containing Type A fly ash	73
5.14	Effect of initial mix temperature on the temperature rise in mortar	74
5.15	Effect of initial mix temperature on the temperature rise in mortar containing fly ash	75
5.16	Effect of cement type on the temperature rise in mortar	76
5.17	Effect of cement content on the temperature rise in mortar	78
5.18	Effect of the water to cementitious materials ratio on the temperature rise in mortar containing fly ash	79
5.19	Effect of the water to cementitious materials ratio on the temperature rise in mortar containing fly ash	80
5.20	Effect of the water to cement ratio on the temperature rise in mortar	81

5.21	Effect of the water to cementitious materials ratio on the temperature rise in mortar containing fly ash	82
5.22	Effect of varying content of Type A fly ash on the temperature rise in Type I-II mortar	83
5.23	Effect of varying content of Type A fly ash on the temperature rise in Type I-II mortar	84
5.24	Effect of varying content of Type B fly ash on the temperature rise in Type I-II mortar	85
5.25	Effect of varying content of Type B fly ash on the temperature rise in Type I-II mortar	86
5.26	Effect of fly ash type on the temperature rise in mortar with 27.5% replacement of Type I-II cement	87
5.27	Effect of varying content of Type A fly ash on the temperature rise in Type I mortar	88
5.28	Effect of varying content of Type A fly ash on the temperature rise in Type I mortar	89
5.29	Effect of varying content of Type B fly ash on the temperature rise in Type I mortar	90
5.30	Effect of varying content of Type B fly ash on the temperature rise in Type I mortar	91
5.31	Effect of fly ash type on the temperature rise in mortar with 27.5% replacement of Type I cement	92
5.32	Effect of varying content of Type A fly ash on the temperature rise in Type III mortar	93
5.33	Effect of varying content of Type A fly ash on the temperature rise in Type III mortar	94
5.34	Effect of varying content of Type B fly ash on the temperature rise in Type III mortar	95
5.35	Effect of varying content of Type B fly ash on the temperature rise in Type III mortar	96
5.36	Effect of fly ash type on the temperature rise in mortar with 27.5% replacement of Type III cement	97
5.37	Effect of admixture addition on the temperature rise in Type I-II cement mortar	99
5.38	Effect of admixture addition on the temperature rise in Type I cement mortar during the initial 12 hours	100

5.39	Effect of admixture addition on the temperature rise in Type I cement mortar during the initial 25 hours	101
5.40	Effect of admixture addition on the temperature rise in Type III cement mortar during the initial 12 hours	102
5.41	Effect of admixture addition on the temperature rise in Type III cement mortar during the initial 25 hours	103
5.42	Effect of the addition of a superplasticizer on the temperature rise in Type I cement mortar containing fly ash	104
5.43	Effect of the addition of a superplasticizer on the temperature rise in Type III cement mortar containing fly ash	105
5.44	Relative compressive strength of Type I-II cement mortars containing fly ash at 7 days	106
5.45	Relative compressive strength of Type I-II cement mortars containing fly ash 28 days	107
5.46	Relative compressive strength of Type I cement mortars containing fly ash at 7 days	108
5.47	Relative compressive strength of Type I cement mortars containing fly ash at 28 days	109
5.48	Relative compressive strength of Type III cement mortars containing fly ash at 7 days	110
5.49	Relative compressive strength of Type III cement mortars containing fly ash at 28 days	111
5.50	Relative flow of Type I cement mortars containing fly ash	113
5.51	Relative flow of Type III cement mortars containing flyash	114
6.1	Maximum temperature rise in mortar vs. percent replacement of Type I-II cement with fly ash	119
6.2	Maximum temperature rise in mortar vs. percent replacement of Type I cement with fly ash	120
6.3	Maximum temperature rise in mortar vs. percent replacement of Type III cement with fly ash	121
6.4	Time to 95percent replacement of Type I-II cement with fly ash	123
6.5	Time to 95percent replacement of Type I cement with fly ash	124
6.6	Time to 95percent replacement of Type III cement with fly ash	125
6.7	Strength development of Type III cement mortars containing flyash	127
6.8	Strength development of Type I cement mortars containing fly ash	128

6.9	Strength development of Type I-II cement mortars containing fly ash	129
6.10	Effect of curing temperature on the relative strength of mortar with and without Type B fly ash	130
7.1	Effect of a lignosulfate based retarder on the temperature rise and the time to the peak temperature in mortar containing no fly ash	134
7.2	Effect of a naphthalene based superplasticizer on the temperature rise and the time to the peak temperature in mortar containing no fly ash	135
7.3	Effect of a superplasticizer on the temperature rise in Type I cement mortar with or without Type A fly ash	137
7.4	Effect of a superplasticizer on the temperature rise in Type I cement mortar with or without Type B fly ash	138
7.5	Effect of a superplasticizer on the temperature rise in Type III cement mortar with or without Type A fly ash	139
7.6	Effect of a superplasticizer on the temperature rise in Type III cement mortar with or without Type B fly ash	140
7.7	Effect of chemical admixture on the 28 day strength of mortar containing no fly ash	142
7.8	Effect of fly ash and chemical admixtures on the flow of mortar	143

LIST OF TABLES

Table	Page
1.1 Fly ash chemical requirements according to different specifications	5
3.1 Thermal movement coefficients [17]	23
3.2 Various properties for fly ashes presented in Figure 3.9 [30]	38
5.1 Results of thermal gradient tests	59
5.2 24 hour compressive strength of mortar	112

CHAPTER 1

INTRODUCTION

1.1 General

The use of pozzolans in the production of mortar is not a new concept in construction. Over 2000 years ago, the Romans discovered that certain volcanic ashes were capable of combining with lime mortar to form a hydraulic cement. The use of pozzolans, particularly fly ash, gained renewed interest in the 1930's after the first comprehensive study of the use of fly ash in concrete by Davis et. al. [1]

The use of fly ash in the construction of Hungry Horse Dam (completed in 1952) is generally considered as the first major use of fly ash in concrete. [2,3] The use of fly ash in concrete has continuously increased since the success of the Hungry Horse Dam mainly because the partial substitution of cement with fly ash in concrete has been found to improve the ultimate strength, workability, and durability of concrete.

The use of fly ash in concrete also can result in lower internal concrete temperatures and cost savings. Other benefits include environmental considerations since the use of fly ash in concrete represents a cost effective alternative to the disposal of a waste by-product. Today, fly ash is considered a basic and essential component in the production of high strength concrete and mass concrete.

1.2 Problem Statement

One of the greatest problems affecting the concrete industry in Texas is the performance of concrete exposed to high temperatures due to atmospheric conditions. This is referred to as hot weather concreting. The major problems resulting from hot weather concreting in fresh concrete are: increased water demand, accelerated slump loss, decreased setting time, and increased tendency for plastic shrinkage cracking. Figure 1.1 shows that the concrete temperature is the greatest single factor affecting the evaporation rate of concrete bleed water. When the rate of evaporation exceeds the rate of bleeding of the fresh concrete, the result is plastic shrinkage cracking. In hardened concrete problems may be decreased strength, reduced durability, increased permeability, and increased tendency for drying shrinkage and differential thermal cracking.

Concrete temperature can be lowered by two methods: 1) precooling of mixture components and mixing equipment or 2) minimizing the temperature rise in the concrete during early ages. Precooling measures include the use of crushed ice in place of mixing

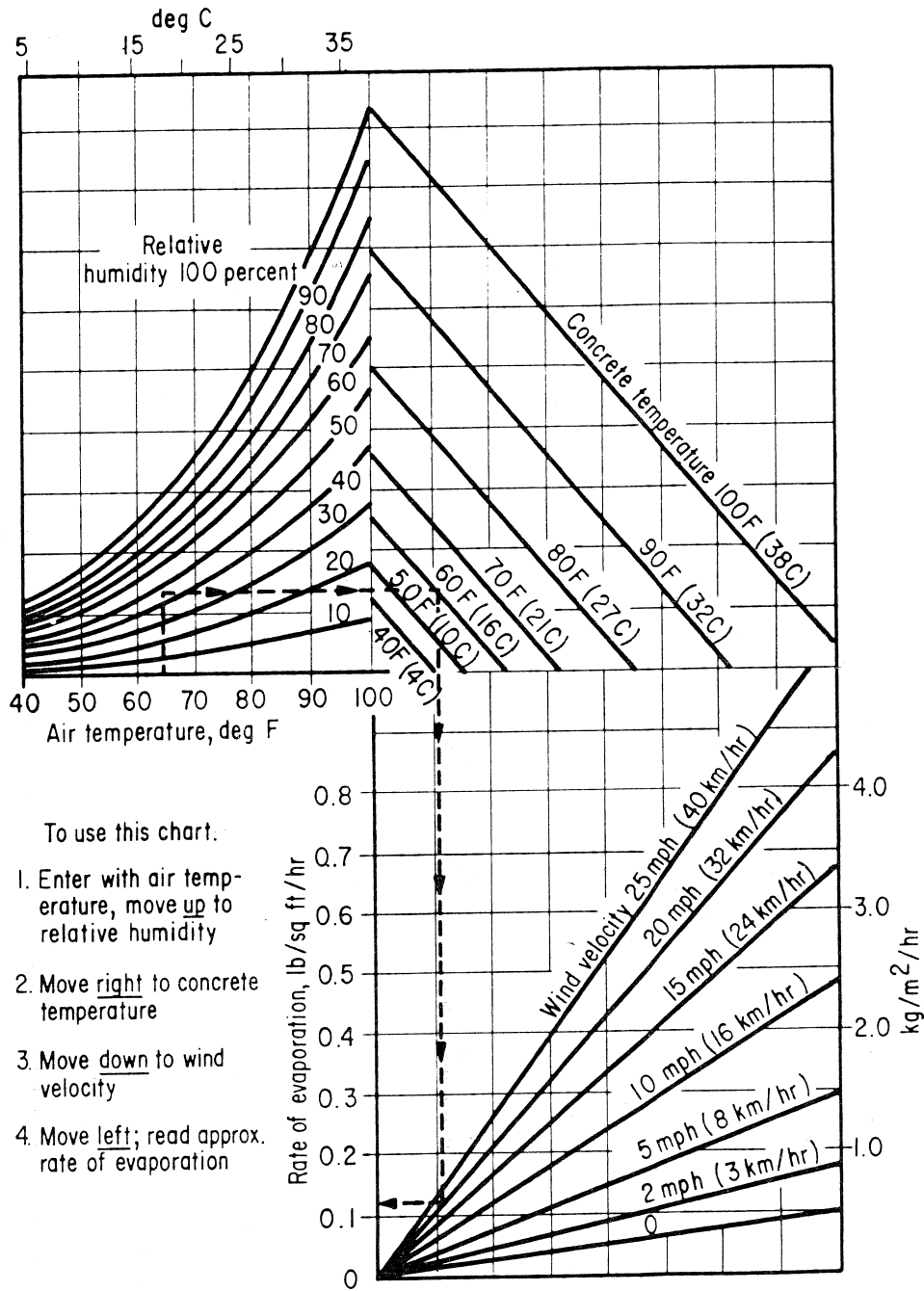

Figure 1.1 Effect of concrete temperature, air temperature, relative humidity, and wind velocity on the rate of evaporation of surface moisture from concrete. [4]

water and cooling of the aggregates. Methods of minimizing the concrete temperature rise include artificial cooling such as chilled pipes, reducing the cement content, changing the cement type, and using mineral admixtures such as fly ash. Fly ash has been used in the concrete in dams for many years because of its lower heat of hydration. It is estimated that the amount of heat produced by fly ash is one-half that produced by an equivalent amount of cement. ^[1] That estimate is dependent on the particular fly ash used. Most of the fly ash used in dam construction classifies as Texas State Department of Highways and Public Transportation (TSDHPT) Type A (ASTM Class F) while much of the fly ash produced in Texas is TSDHPT Type B (ASTM Class C). Currently, there is no data available on the effect of Texas fly ashes on the temperature rise in concrete. Before fly ash is used in concrete for controlling the temperature rise, the effect of variables such as type of cement, mix proportions, physical and chemical properties of the fly ash, and the ambient temperature must be studied and fully understood.

1.3 Definition of Fly Ash

Fly ash is a by-product from the burning of pulverized coal in the generation of electricity. Fly ash refers to the fine particles that rise with the flue gases and are collected in the stack by particulate collectors such as electrostatic precipitators, mechanical collectors, or fabric filters rather than being discharged as an atmospheric pollutant.

Fly ashes exhibit pozzolanic activity. A pozzolan is defined as "a siliceous or siliceous and aluminous material which in itself possesses little or no cementitious value but which will, in finely divided form and in the presence of moisture react with calcium hydroxide at ordinary temperature to form compounds possessing cementitious properties". ^[5] Pozzolans react chemically with the alkalis in the Portland cement as well as with the calcium hydroxide or hydrated lime liberated during the hydration of portland cement to form stable strength producing compounds. ^[2] The cementitious compounds resulting from the reaction of the fly ash with calcium are calcium silicate hydrates which are very similar to those resulting from the hydration of Portland cement.

1.4 Coal

Coal is formed by the decomposition of plant matter, without free access to air, under the influence of moisture, pressure, and temperature. Coal is primarily composed of oxygen, hydrogen, and carbon. The chemical composition of the coal changes with time as lower oxygen and hydrogen contents and higher carbon contents are associated

with the coal age. [6] The higher carbon content coals yield more BTU's per unit weight of coal, therefore the older more efficient coals of the eastern United States have been a more popular energy source. Coals are ranked by degree of coalification (calorific value). From low to high, the ranking is peat, brown coal and lignite, subbituminous, bituminous (soft coal), anthracite (hard coal), and graphite. Lignite and brown coal are the lowest ranking fuels commonly referred to as coal. The degree of coalification is also apparent from the appearance of the coal as lignite is a brownish coal in which metamorphosed wood may be noticeable whereas anthracite is black with a semimetallic shine. Despite their lower calorific values, the use of lignite and subbituminous coals has increased with the increased efficiency of production of electricity from the burning of coal, and the need for additional domestic energy supplies.

1.5 Fly Ash Classification

The ash resulting from the combustion of coal mainly consists of oxides of silicon, aluminum, iron and calcium. ASTM C618 groups fly ashes as Class F and Class C, primarily based on the sum of the percentages of silicon, aluminum, and iron oxides. [7] The sum of silicon dioxide plus aluminum oxide plus iron oxide must be greater than 70 percent for a Class F fly ash and greater than 50 percent for a Class C fly ash as shown in Table 1.1. A Class F fly ash could also be classified as a Class C fly ash if the maximum water requirement for a Class C fly ash is met by a Class F fly ash. Class F ashes are normally produced from burning anthracite or bituminous coals (generally eastern coals) and have pozzolanic properties. Class C ashes are normally produced from lignite or subbituminous coals (western coals) and have both cementitious properties and pozzolanic properties. The cementitious properties of the Class C ashes are primarily due to the higher calcium oxide (lime) content which reacts to form calcium silicate hydrates. ASTM C618 indirectly recognizes the cementitious properties of Class C ashes by lowering the minimum amount of silicon, aluminum, and iron oxides which allows for a greater percentage of calcium oxide.

The Texas State Department of Highways and Public Transportation (TSDHPT) classifies fly ashes as Type A or Type B. It can be seen from Table 1.1 that the requirements for a Type A fly ash correspond to those of an ASTM Class F fly ash, and the requirements for a Type B fly ash correspond to those of a Class C fly ash. Slight differences do, however, exist between the ASTM fly ash classification and the TSDHPT fly ash types. The TSDHPT standards provide a more consistent fly ash composition by having lower allowable limits on moisture content, loss on ignition, and percentage

Table 1.1 Fly Ash Chemical Composition Requirements According to Different Specifications

Fly Ash Chemical Composition Requirements				
	ASTM 618-84		Texas DSHPT D-9-8900	
	Class C	Class F	Type A	Type B
Si + Al + Fe minimum %	50	70	65	50
Ca oxide maximum %	--	--	*	*
Mg oxide maximum %	--	--	5.0	5.0
Sulfate maximum %	5.0	5.0	5.0	5.0
Available Alkalies as Na oxide maximum %	1.5	1.5	1.5	1.5
Loss on Ignition maximum %	6.0	6.0	3.0	3.0
Moisture maximum %	3.0	3.0	2.0	2.0
Fineness #325 maximum retained	34	34	30	30
Pozzolanic Activity	75	75	75	75
Shrinkage maximum %	.03	.03	.03	.03

* 4% maximum variation from previous ten samples

retained on the #325 sieve. Further, if the sum of the Si, Al, and Fe oxides in fly ash is greater than 65 percent that fly ash is designated as a Type A fly ash as per TSDHPT specifications compared to 75 percent for a Class F fly ash as per ASTM C618. The TSDHPT designations will be used in this report.

1.6 Research Objectives

This report is the first in a comprehensive study on the effect of fly ash produced in Texas as a Portland cement replacement in reducing the temperature of concrete. The evaluation of fly ash as a partial cement replacement is to be made on the basis of tests conducted to determine the internal temperature rise, strength, and flow of fly ash and cement mortar samples. Guidelines have been developed in this study for the proper selection and use of fly ash in controlling the temperature of fresh concrete to ensure better and more durable concrete.

In this study, the nature of the thermal gradient along a vertical cross section of a concrete member is examined. Knowledge of the shape of the thermal gradient is beneficial in reducing the potential for thermal cracking of concrete. In this study, research on the thermal gradient in concrete is limited to the gradient produced by the hydration of cement.

1.7 Report Format

This report consists of eight chapters. The second chapter provides a brief overview of the chemistry of the hydration of cement and fly ash. A review of the published literature on the temperature rise in concrete, strength of concrete containing fly ash, and the workability of concrete containing fly ash is presented in Chapter 3. Chapter 4 outlines the experimental program followed. Chapters 5, 6, and 7 contain a presentation and discussion of the test results. Summary, conclusions, and recommendations for further research are given in Chapter 8.

CHAPTER 2
CHEMISTRY OF THE HYDRATION OF PORTLAND CEMENT
AND FLY ASH

2.1 General

The compounds of Portland cement and fly ash are anhydrous products from high temperature reactions. When cement or fly ash compounds are hydrated they form lower-energy compounds which are accompanied by the evolution of heat; therefore the hydration of cement and fly ash is exothermic.

Because cement is a mixture of several anhydrous compounds, the hydration of cement involves the reaction of different compounds at different times and at different rates. The different reactions however do not occur independently of each other. In this section, a brief overview is presented of the reactions associated with the four major compounds found in Portland cement and the reaction of cement with fly ash. The chemical symbols used are those particular to cement chemistry and are defined as follows:

OXIDE	CEMENT NOTATION	COMMON NAME
CaO	C	Lime (Calcium)
SiO ₂	S	Silica
Al ₂ O ₃	A	Alumina
Fe ₂ O ₃	F	Ferric Oxide
SO ₃	S	Sulfur Trioxide
H ₂ O	H	Water

Four major components of cement are tricalcium silicate, dicalcium silicate, tricalcium aluminate, and tetracalcium aluminoferrite which are symbolically represented as C_3S , C_2S , C_3A , and C_4AF respectively.

2.2 Hydration of Silicates

The hydration of C_3 can be viewed as a five stage process which proceeds as a rapid reaction upon contact with water, a dormant period, an acceleration period, a deceleration period, and a steady state. Those five stages are shown in Figure 2.1.

Briefly after Portland cement is mixed with water, the water becomes super-saturated with calcium hydroxides as C_3S dissolves into hydrated calcium silicate and

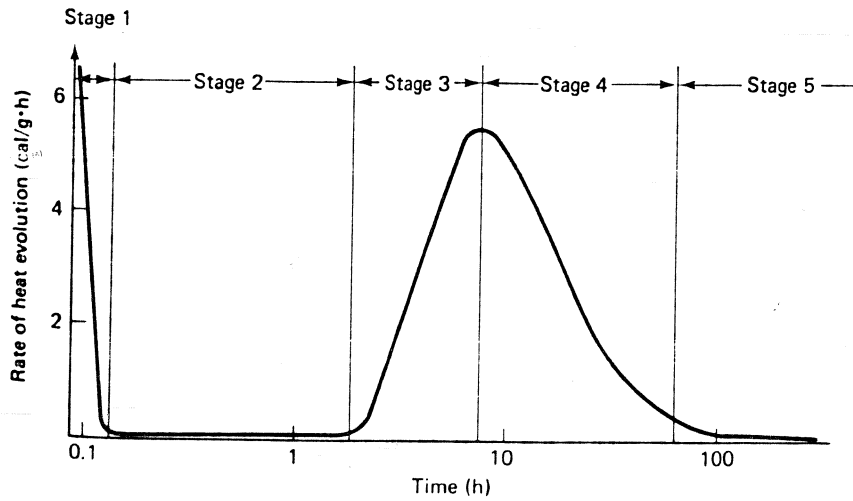

Figure 2.1 Rate of heat evolution during the hydration of tricalcium silicate. [8]

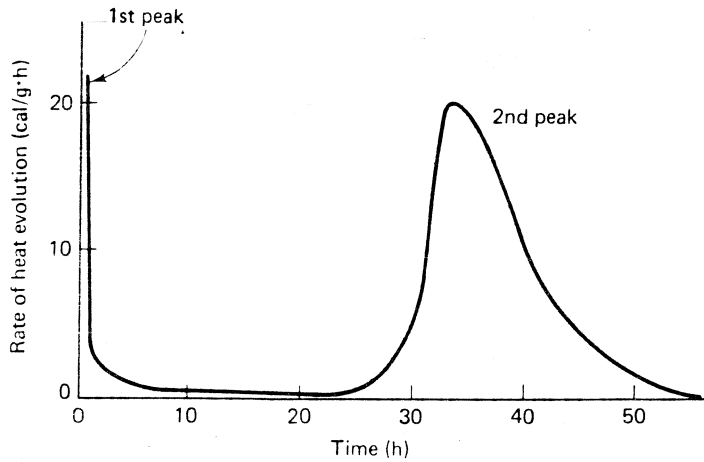
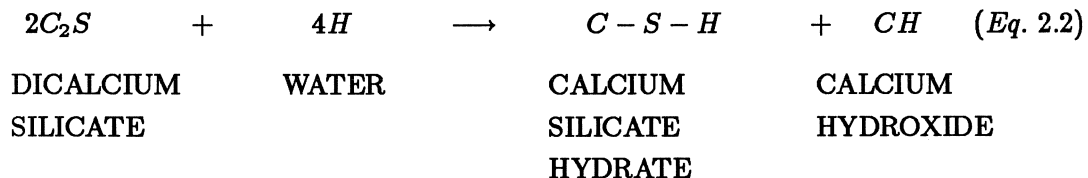
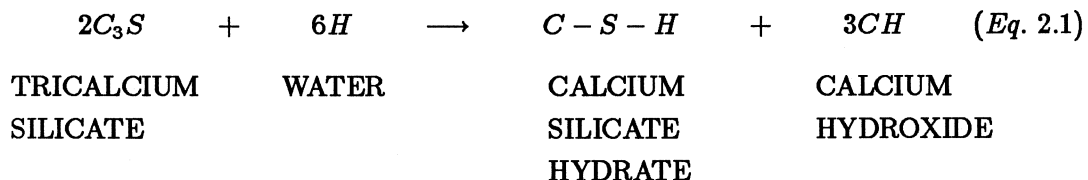

Figure 2.2 Rate of heat evolution during the hydration of tricalcium aluminate with gypsum. [8]

calcium and hydroxide ions. This period of rapid heat evolution (stage 1) lasts approximately 15 minutes until the pH rise caused by the production of calcium and hydroxide ions slows the reaction of C_3S into what is called the dormant period (stage 2). The dormant period lasts 2 to 4 hours. After the dormant period, hydration resumes due to the elimination of insoluble hydrated silicates and excess lime in solution to bring the concentration of hydroxide in the water to its normal level of saturation. With the lower pH, the hydration of C_3S is again accelerated (stage 3) and C-S-H (calcium silicate hydrate) molecules form at the surface of the C_3S molecules. C-S-H molecules are the primary strength producing compounds in hardened cement paste. As hydration continues, the hydration products slow the migration of water to the unhydrated C_3S grains and the rate of reaction again slows down (stage 4). Hydration continues at an increasingly slower rate as the diffusion controlled reactions face more diffusion barriers. [8,9]

The controlling mechanisms can be thought of as through - solution hydration and solid state hydration. In through - solution hydration, anhydrous compounds are dissolved into ionic compounds and reorganized in solution (stages 1, 2, and 3). Solid state hydration takes place at the surface of cement particles without going into solution (stages 4 and 5). [10]

The hydration of C_2S is similar to C_3S but occurs at a slower rate and produces less calcium hydroxide. The reactions of C_3S and C_2S are symbolically described as follows:



The reaction product calcium silicate hydrate is listed as C-S-H because it is not formed in constant stoichiometric proportions.

2.3 Hydration of Aluminates and Ferrites

The reaction of C_3A with water occurs immediately. To prevent flash set of the concrete, gypsum is added to control the reaction of C_3A with water. The resulting products from the hydration of tricalcium aluminate are dependent on the concentration of sulfate and aluminate in the solution phase. The high-sulfate product is calcium aluminate trisulfate hydrate which is commonly referred to as ettringite and the low-sulfate product is calcium aluminate monosulfate hydrate which is commonly referred to as monosulfoaluminate hydrate or monosulfate. Ettringite is generally the first to crystallize because of the high sulfate to aluminate ratio in the first hour of hydration. ^[10] When, or if, the sulfate supplied by gypsum is depleted, the rate of reaction of C_3A increases and the aluminate concentration increases. The ettringite becomes unstable and is converted to monosulfate. The hydration of tricalcium aluminate is shown in Figure 2.2.

The reaction of C_4AF is similar to C_3A , but is generally a little slower. Iron oxide apparently plays the same role as alumina during hydration (F can substitute for A in the hydration products). ^[8] The reactions of C_3A and C_4AF are summarized symbolically below.

In the presence of a high sulfate concentration ettringite is formed. This is the most common initial reaction of C_3A during the hydration of ordinary Portland cement.

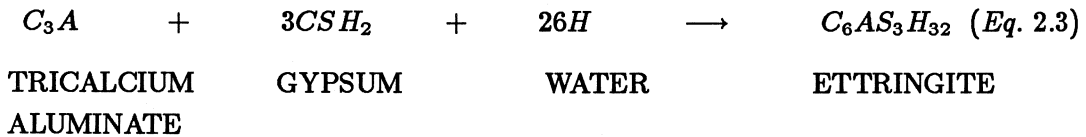

Ettringite is a stable compound only if the sulfate concentration is high. The formation of monosulfate occurs when there is an insufficient supply of sulfate ions to form ettringite from the aluminate ions.

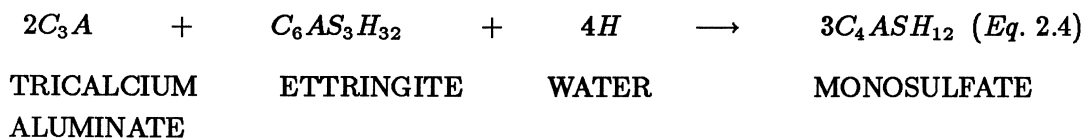

If a low content of gypsum is in the cement resulting in an insufficient sulfate content, monosulfate may be formed directly.

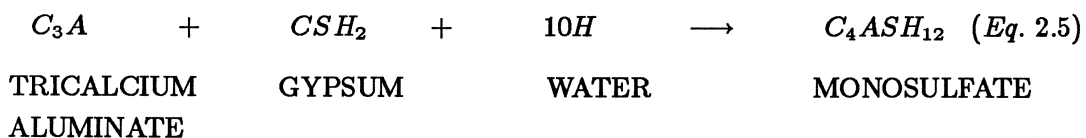

In the absence of sufficient sulfate to form ettringite or monosulfate the following reactions occur:

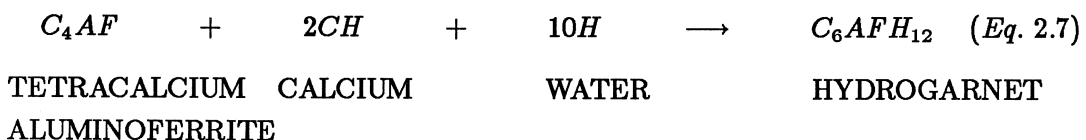
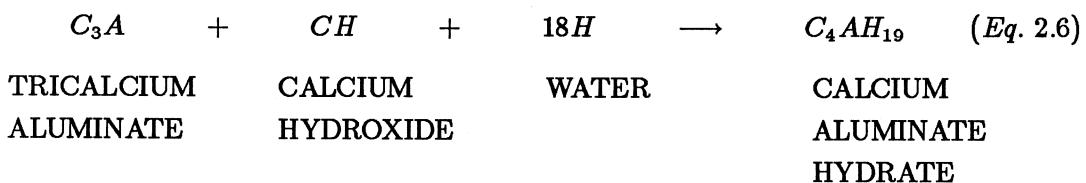

The reactions represented by equations 2.6 and 2.7 consume calcium hydroxide and thus compete directly with pozzolans for the lime released by the hydration of

silicates. In addition, the reactions represented in equations 2.3 and 2.5 also consume calcium and are affected by any process which lowers the calcium ion concentration. ^[6]

The combined effect of the reactions of the components of Portland cement on the rate of heat evolution during hydration is shown in Figure 2.3.

2.4 Effect of W/C Ratio on the Hydration of Cement

The water to cement ratio is believed to affect the hydration of cement by aiding or hindering early hydration products. Figure 2.4 shows that as the W/C ratio is progressively raised from 0.3 to 0.5, increased quantities of ettringite are formed from 5 minutes to 2 hours after contact with water. C-S-H is not detectable at such early ages. The explanation for this increase in ettringite with the increase in water content is that there is more aqueous medium available for both dissolving the calcium and sulfate and for transporting them to the aluminate and ferrite surfaces where the formation of ettringite occurs. ^[11]

2.5 Reaction of Cement and Fly Ash

The reaction products of a fly ash and cement mixture are essentially the same as those produced from ordinary Portland cement; namely: C-S-H, calcium hydroxide, calcium aluminate hydrate, ettringite, monosulfoaluminate hydrate, and hydrogarnet. The most important reaction is between silica and calcium hydroxide (pozzolanic reaction) which forms the strength producing calcium silicate hydrates. In addition, the pozzolanic reaction can also produce aluminate hydrates.

It has been observed that lime can react with the iron oxide of the fly ash. There generally is, however, little of the reactive glassy phase iron in fly ash. Thus the reaction of iron and lime should produce little heat. ^[6]

The partial replacement of cement with fly ash has four main effects related to concrete temperature rise:

- 1) The cementitious reaction of the calcium in fly ash produces heat at a rate similar to the hydration of cement. Cementitious reactions are particularly important in the generation of heat by high calcium Type B fly ashes.
- 2) The reduction in cementitious material lowers the amount of heat evolved at early ages which in turn reduces the reaction rates. High calcium fly ash may contribute significantly to the early heat production, however.

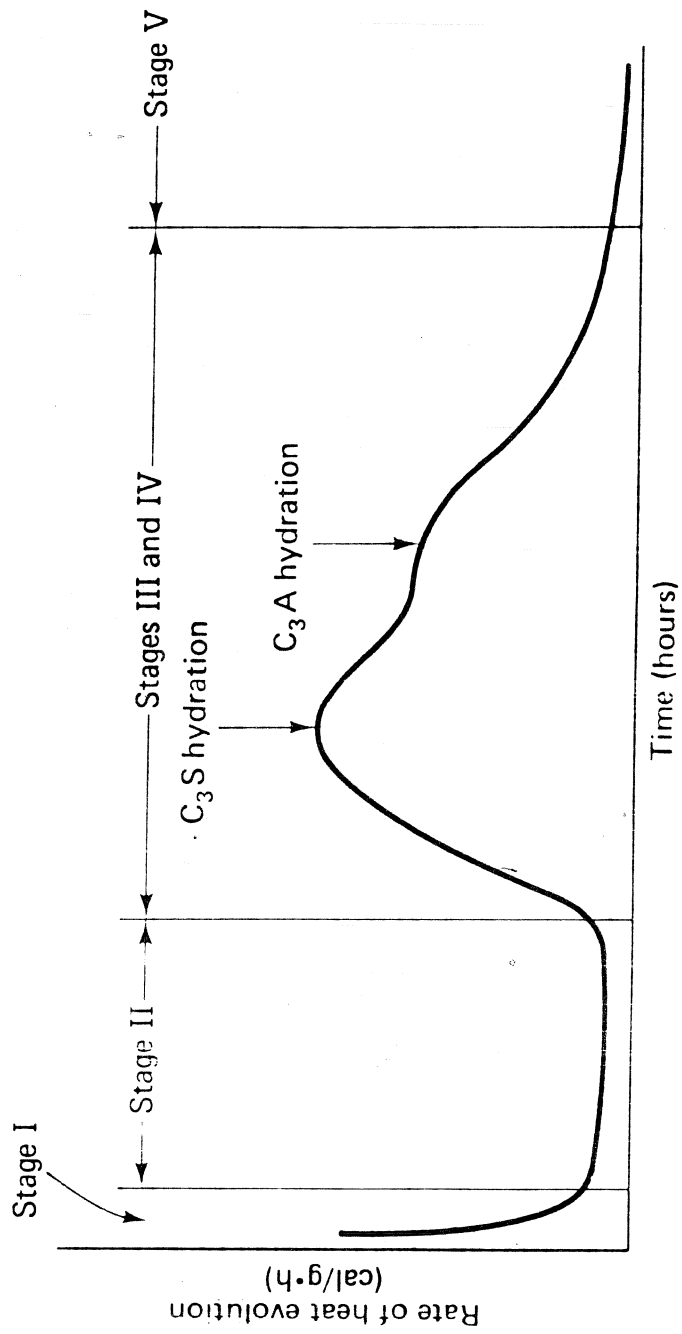

Figure 2.3 Rate of heat evolution during the hydration of Portland cement. [8]

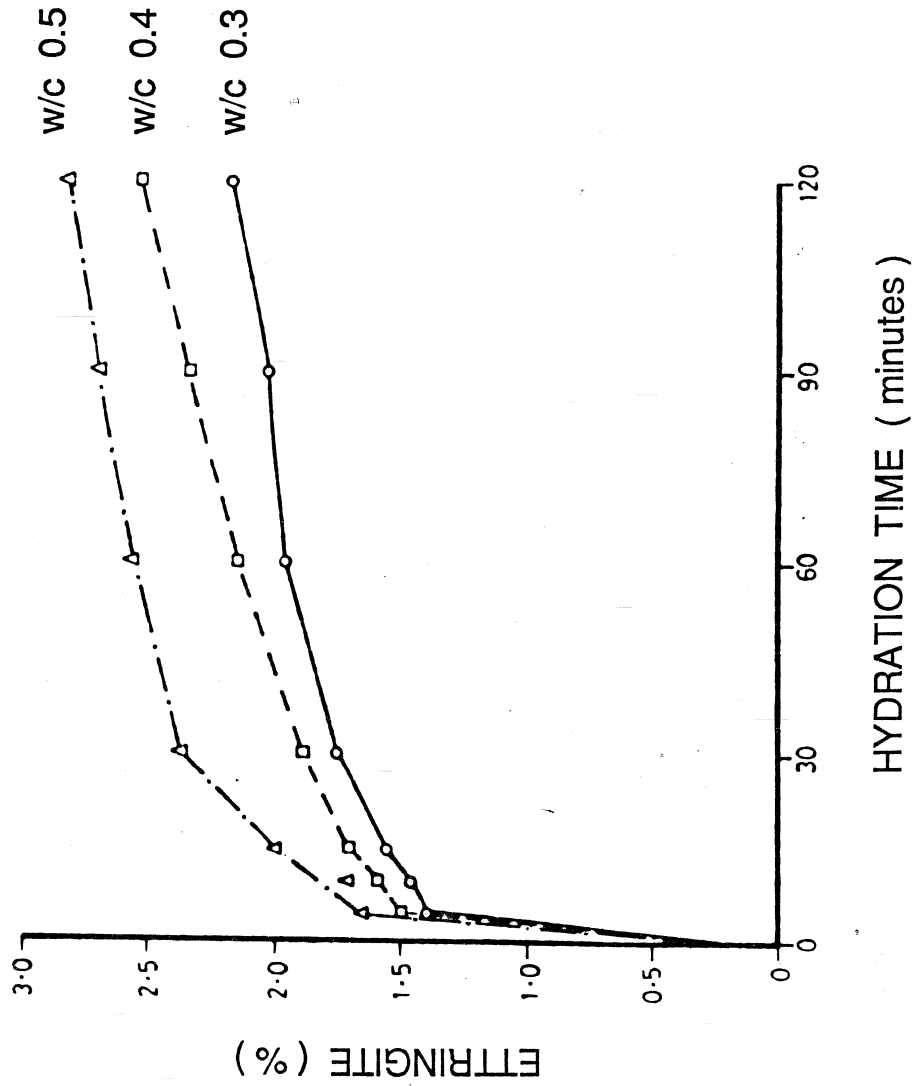

Figure 2.4 Ettringite Production vs. Hydration Time for ordinary Portland cement. [11]

- 3) The pozzolanic activity of the fly ash produces C-S-H and thus liberates heat. The heat liberated by the pozzolanic reaction of fly ash occurs at a much later time than the peak rate of heat generation of cement and thus the concrete temperature is lowered in nonadiabatic conditions.
- 4) The rate of hydration of the cement is increased by the “finely divided powder effect”.

2.6 Pozzolanic Reaction

The most important property of the pozzolanic reactivity of fly ashes affecting the internal temperature rise in concrete at early ages is when the pozzolanic reaction begins. Two ways to measure the degree of pozzolanic reaction are indirectly by compressive tests and directly by observing the hydration products.

Research has shown that when Portland cement is replaced by Type A fly ash on a one - to - one basis (by weight or volume), the resulting mortar and concrete does not achieve the same strength as similar mixes without flyash at normal temperatures in less than 6 months. (Figure 2.5) ^[12,13] High calcium Type B fly ashes can achieve an equivalent strength at early ages. ^[3]

The slow rate of the pozzolanic reaction can also be seen by analyzing the hydration products. The Cement and Concrete Association found that the amount of portlandite $[\text{Ca}(\text{OH})_2]$ increased within a Portland cement and fly ash paste until approximately 14 days. ^[13] Figure 2.6 shows that the rate of hydration of the cement is greater than the pozzolanic reaction for the first 2 weeks. Thus it appears that the heat production due to pozzolanic reactions will be minimal in the first 24 hours monitored in this study.

2.7 Finely Divided Powder Effect

A finely divided powder, such as fly ash, has been found to act as an accelerator at normal temperatures by increasing the rate of hydration. ^[14] That effect, known as “the finely divided powder effect”, is believed to be the result of replacing cement with fine particles that act as nucleation sites for C-S-H and other hydration products and not as an indication that fly ash is more reactive than cement. ^[6] This effect can also be seen from the results of strength tests shown in Figure 2.7 in which concrete with Type A fly ash had the same strength as concrete with quartz powder (an unreactive, fine powder) up to an age of 7 days. ^[14]

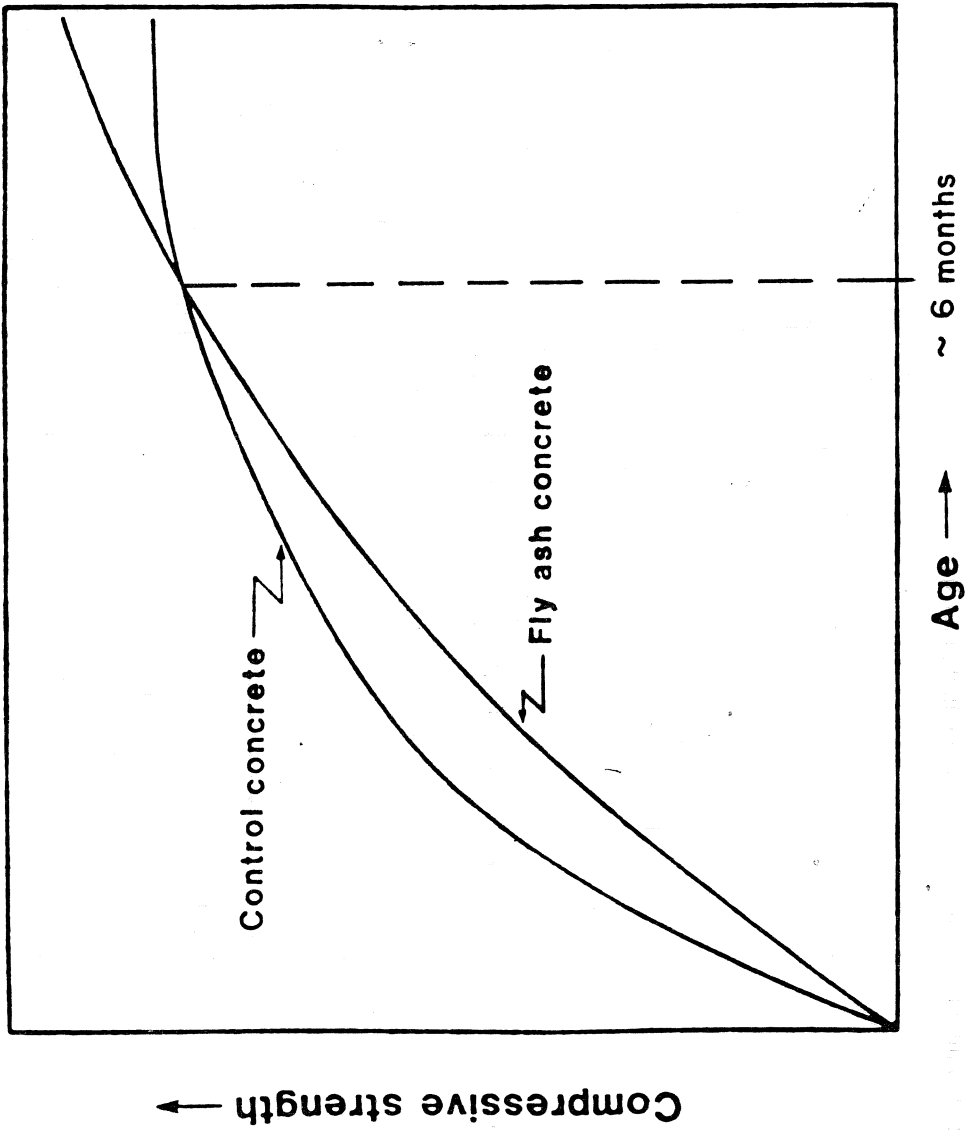

Figure 2.5 Typical rates of strength increase for plain concrete and fly ash concrete proportioned by simple replacement. [3]

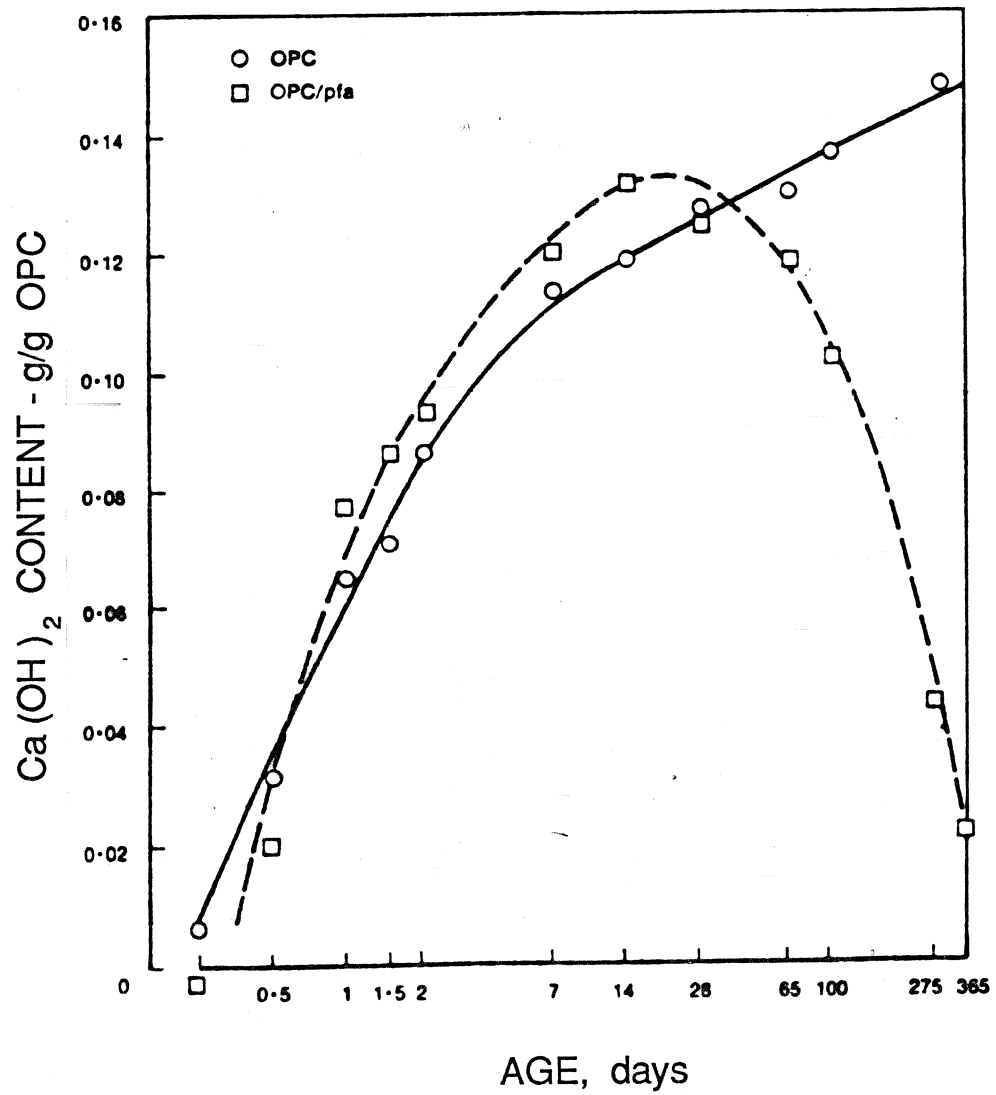

Figure 2.6 Portlandite content per unit weight of ordinary Portland cement (OPC) vs. age of hydration. [13]

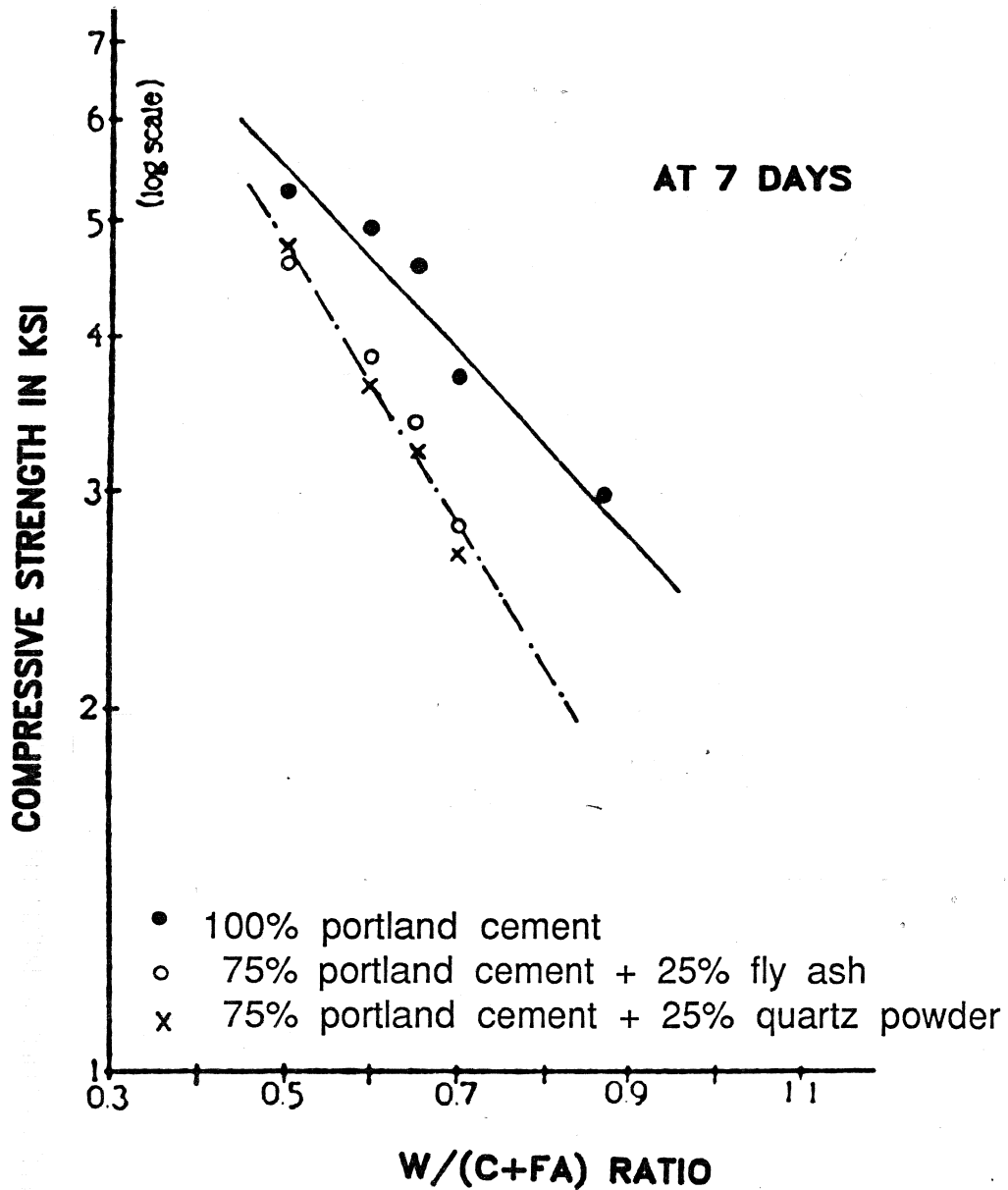

Figure 2.7 Cube strengths of concretes with and without mineral admixture as a function of the water to cementitious materials ratio. [14]

2.8 Effect of Particle Size on Hydration

In addition to the catalytic finely divided powder effect, the rate of most reactions increase as the particle surface area to volume ratio increases. This is also the case for the hydration of cement which occurs at the particle surfaces. Inspection of the cement mill reports for the Type I and Type III cements used in this study show nearly the same chemical compositions but the additional grinding of the Type III into a finer powder causes a great increase in the rate of hydration.

It is generally believed that the reactivity of fly ash also increases with fineness. Unfortunately, the effect of fly ash fineness is difficult to assess because of the discrepancies between the different measures of fineness, and because the finer fly ashes tend to have a high calcium content. Both calcium content and fineness increase the reaction rate.

The Blaine Air Permeability Test determines the specific surface area based on the flow of air through the particles in a porous bed. The specific surface area depends mainly on the amounts of the finest particles.

The other measure of fineness is by particle size distribution. This generally defines fineness as the percentage retained on the #325 sieve and does not give an indication of the amounts of the finest particles. There appears to be substantial discrepancies between measuring fineness by surface area and by particle size distribution. This discrepancy appears to be truer for fly ashes than for Portland cement because of the influence of carbon (loss on ignition) on the two test methods. ^[6]

The chemical analysis of fly ashes shows a strong correlation between the percent retained on the #325 sieve, and the two properties of specific gravity and CaO content as shown in Figure 2.8. ^[6,15] It also has been shown that the SiO₂ and CaO contents of fly ashes produced in Texas are essentially the only variable major constituents in fly ash composition. ^[15] The increase in CaO content is compensated for by the SiO₂ component. This means that as fineness increases so does the CaO content; both which increase the early age reactivity of the fly ash and make the effect of each on the rate of hydration inseparable without altering the ash as produced. The correlations between chemical composition are based on statistical analyses and may or may not be related to the properties of fly ash. For example, the finer particles of the Type B fly ashes may be the result of burning lignite and subbituminous coal in newer, more efficient plants.

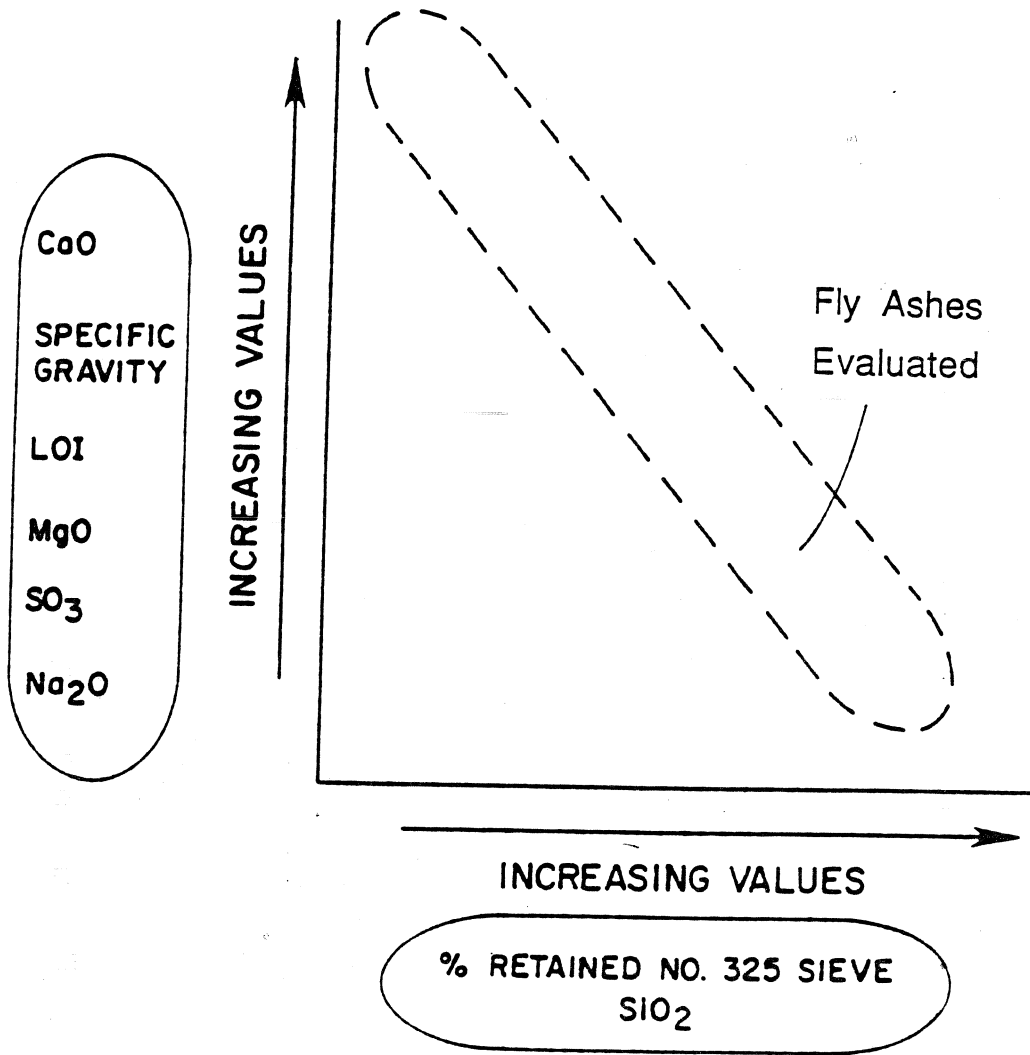

Figure 2.8 Compositional tendencies of Texas fly ashes based on statistical analysis. [15]

CHAPTER 3 LITERATURE REVIEW

3.1 Introduction

The material in this chapter is presented to provide a background of other work conducted in the areas pertaining to this study. Those areas are temperature rise in concrete, strength of fly ash concrete, workability of fly ash concrete, and the effect of chemical admixtures on the hydration of cement.

3.2 Temperature Rise in Concrete

The hydration of cement is an exothermic reaction. The heat liberated causes an increase in the internal temperature of the concrete. The heat of hydration of cement may be as high as 180 BTU's per pound of cement (100 calories per gram) which could cause a temperature rise of approximately 135°F (75°C) if no heat loss occurred. [12] Fortunately, even mass concrete does not produce a truly adiabatic condition and a temperature rise in the range of 55 - 90°F (30 - 50°C) is more likely to occur in service.

A high internal temperature in itself can be detrimental to concrete by reducing the ultimate strength, and increasing the tendency for plastic and drying shrinkage. Perhaps a greater problem associated with the concrete temperature rise is thermal stresses which develop when the exposed exterior concrete surface eventually cools to its environment. If restraint is present and the thermal gradient across the member is great enough, cracks due to tensile stresses develop in the young, weak concrete. It is important to emphasize that high temperatures by themselves do not cause concrete to crack. Rather, cracks result when the relative strain changes due to a temperature gradient produce stresses greater than the tensile strength of the concrete.

The cracks resulting from thermal stresses are important to the engineer because thermal cracks can decrease the structural integrity of the concrete and can cause serviceability problems. Such serviceability problems are excessive deflections due to a decreased section, and decreased durability resulting from the corrosion of reinforcing steel, freeze-thaw damage, and increased sulfate attack resulting from the ease of penetration of sulfates through the cracks.

A classical analysis of thermal stresses in plates is presented by Timoshenko.^[16] The thermal stresses (σ) developed in a plate due to the restraint of curvature caused by

a nonuniform temperature change through the depth of the member can be calculated from the following equation:

$$\sigma = \alpha * E * T / (1 - \mu) \quad (\text{Eq. 3.1})$$

where: α = coefficient of thermal expansion

E = elastic modulus

μ = Poisson's ratio

T = a function of the nonuniform vertical temperature distribution (degrees)

A function of the temperature distribution, T , may be of the form of:

$$T = T_o * (1 - y^2/c^2) \quad \text{for a parabolic gradient} \quad (\text{Eq. 3.2})$$

or

$$T = T_o * (1 - y/c) \quad \text{for a linear gradient} \quad (\text{Eq. 3.3})$$

where: T_o = difference between temperature at mid-depth and at the surface

c = 1/2 the plate thickness

y = distance from the point in question to mid-depth

If the plate is restrained externally, the stresses resulting from the uniform temperature change over the depth of the plate are added to the stresses resulting from the nonuniform temperature distribution calculated from Eq. 3.1.

Both of those gradients (T) assume the maximum temperature is at the surface. The classical method for calculating thermal stresses in plates shows that the thermal stresses developed are a function of the thermal gradient and not just of the difference in temperature at mid-depth and at the surface unless a linear temperature gradient is valid.

Experimentally, the stress-inducing thermal strains (ϵ) at mid-depth in concrete have been found by Bamforth ^[17] to be of the following form:

$$\epsilon = \Delta T * (c_f - c_a) \quad (\text{Eq. 3.4})$$

where: ΔT = change in temperature

c_f = free thermal movement coefficient (strains/degree)

c_a = apparent thermal movement coefficient measured in situ (strains/degree)

The results of Bamforth's study are shown in Figures 3.1 and 3.2 and Table 3.1.

CONCRETE MIX	THERMAL FREE (C_a)	MOVEMENT ACTUAL (C_f)	COEFFICIENT** RESTRAINED ($C_a - C_f$)
OPC*	11.1	10.0	1.1
OPC*/FLY ASH	12.1	10.5	1.6
OPC*/GRANULATED SLAG	11.7	10.1	1.6

* OPC = Ordinary Portland cement

** The thermal movement coefficients given in Table 3.1 are expressed in microstrain per degree C.

Alternately, ACI 207 ^[18] uses a tensile restraint factor, K_r , to estimate the stress-producing thermal strains. The stress-producing strains are:

$$\epsilon = \Delta L * K_R * E_c \quad (\text{Eq. 3.5})$$

where: ΔL = movement if no restraint

K_R = tensile restraint factor (Figure 3.3)

[$K_R=1.0$ is total restraint, $K_R=0.0$ is no restraint]

E_c = modulus of elasticity when ΔL occurs

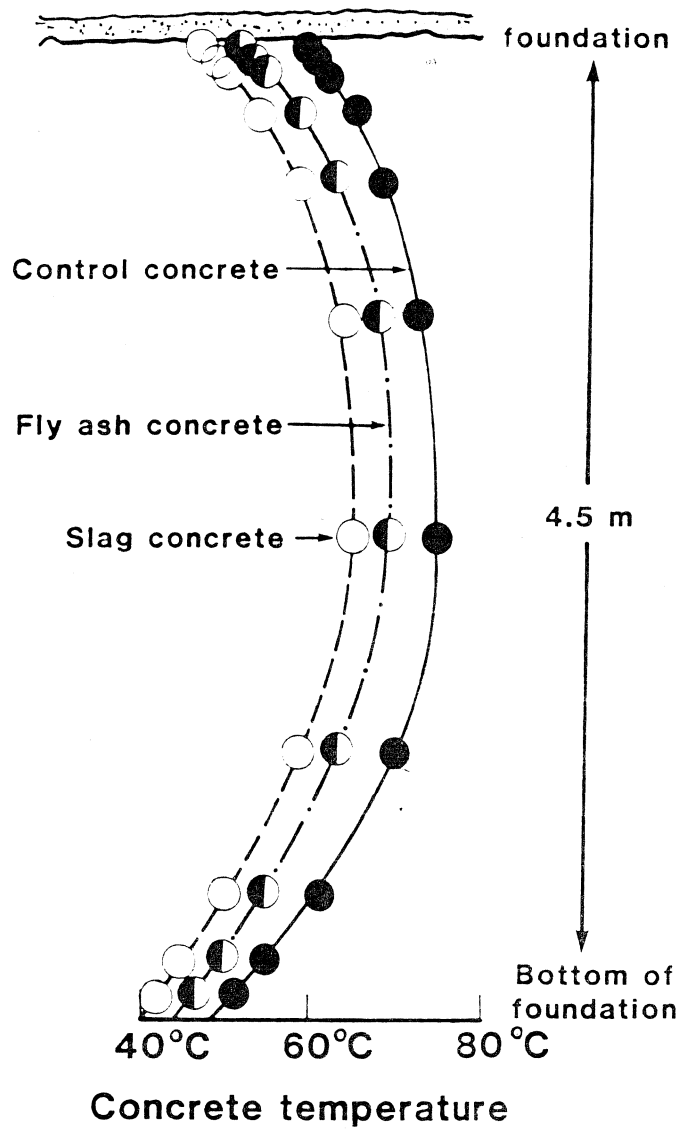

Figure 3.1 Vertical temperature gradient recorded at time of maximum temperature rise in fly ash, slag, and plain concrete foundation units. [17]

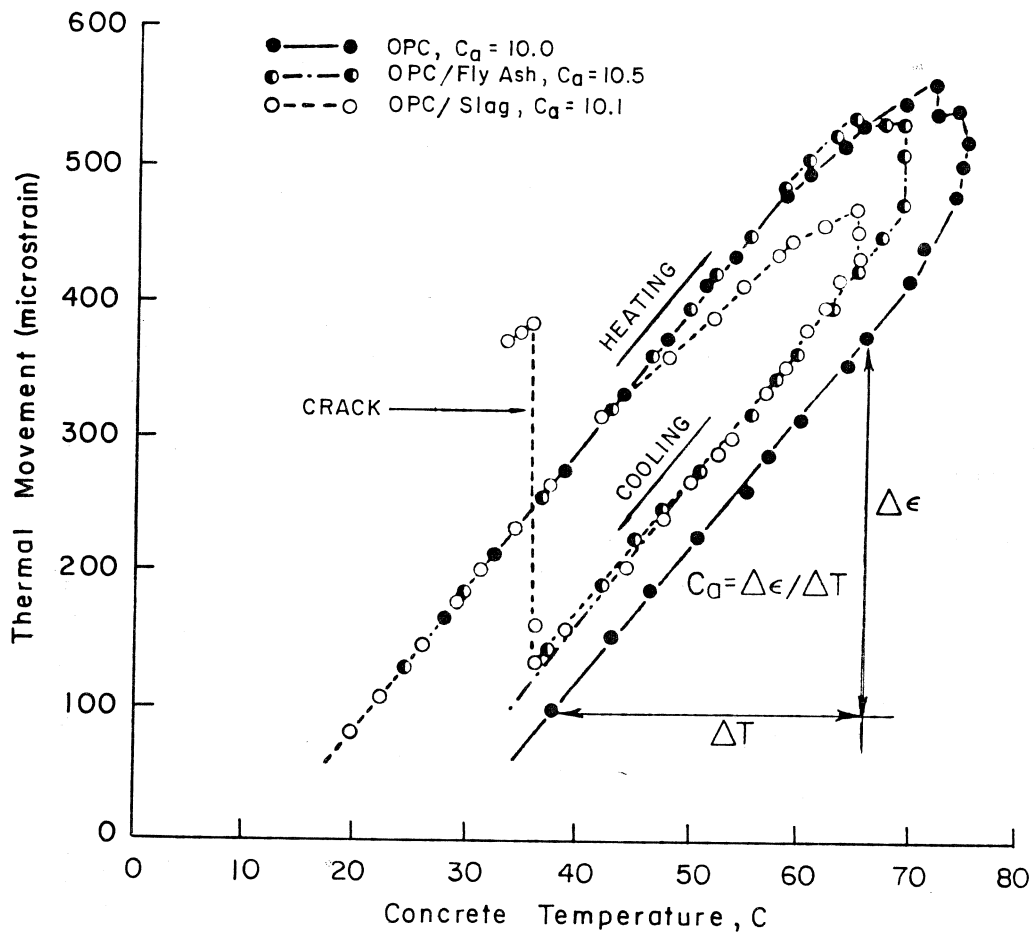

Figure 3.2 Relationship between strain and temperature recorded at mid-height of concrete foundations. [17] OPC = Ordinary Portland cement

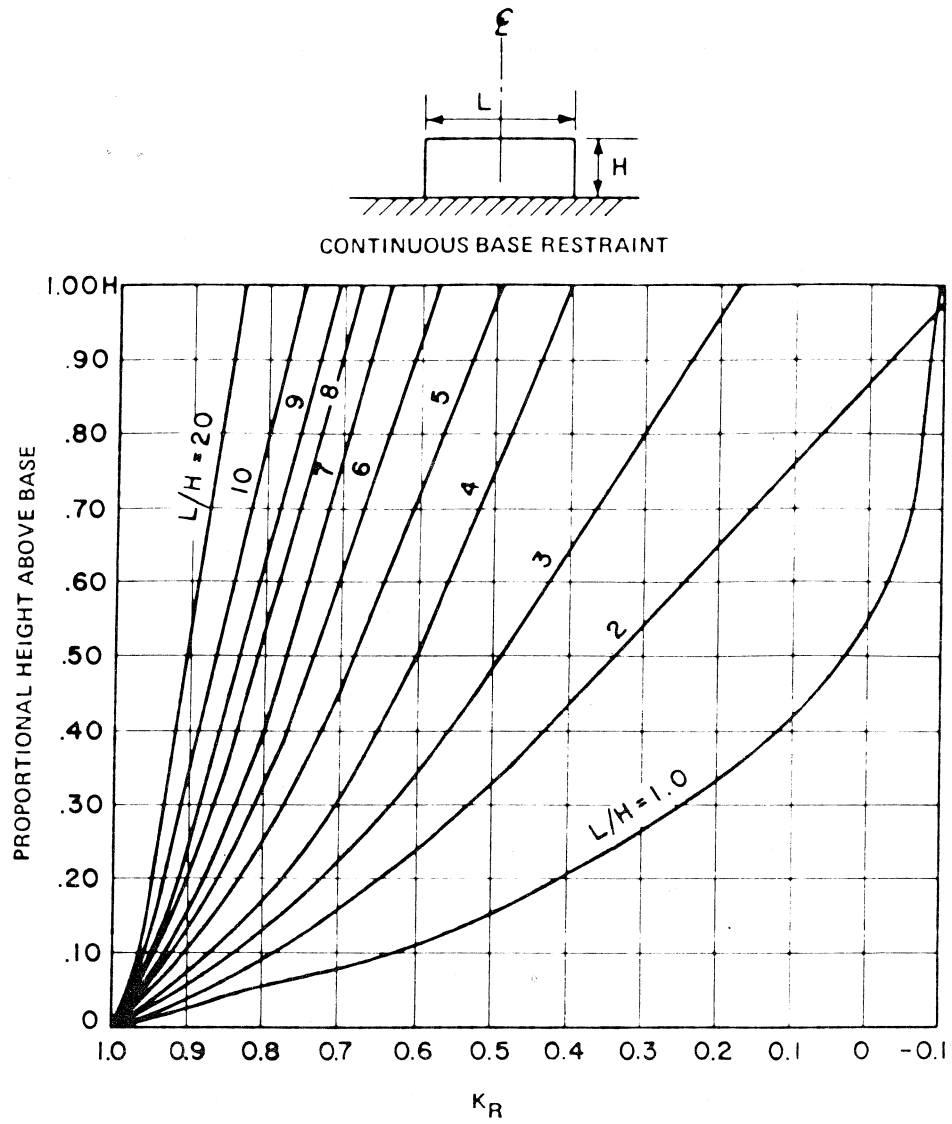

Figure 3.3 Degree of tensile restraint at center section. [18]

Regardless of the formula used, the difficulty in predicting the thermal stresses is a result of the uncertainty of the restraint provided within the concrete. Internal restraint is dependent on the volume change within the member. The internal restraint adds to the external restraint, but obviously cannot be greater than 100 percent. Therefore if the external restraint is great, the internal restraint is negligible.

Internal restraint is similar to continuous base surface restraint, except that the internal restraint acts at the plane where the stress is zero on the vertical stress profile. If the depth of the tensile stress block (distance from surface to point of zero stress) is large in relation to the distance between the joints, the stresses induced due to volume change are low. ^[18] The reason for the greater stress from a shallow depth of the plane of zero stress is that the restraint provided by the plane of zero stress to the surface concrete is greater the nearer to the surface. A similar trend is shown in Figure 3.3. The degree of restraint provided by the concrete can be estimated using Figure 3.3 by setting H as the depth of the tensile stress block and L as the length between joints.

The internal restraint in mass concrete can be reduced by decreasing the maximum temperature rise or by rapid placement of subsequent pours. The faster rate of pours reduces the exposure time of the previous pour which tends to make the isotherms continuous across the pour joint, and obviously the less time that the previous lift has to set the less stiff it is. ^[19] Continuous isotherms across the pour joint reduce the relative thermal strains and the resulting thermal stresses.

The thermal gradients on a vertical cross section in Figure 3.1 are parabolically shaped. That is because the foundations cast were insulated on the bottom by earth and binding concrete and on the top by slag and polyethene. Because the gradient in each foundation was not great, it was found by Bamforth ^[17] that the stress-producing strains were low. The low strains resulted from low internal restraint as shown by the large value for the actual thermal movement coefficient (c_a) in Table 3.1.

Conversely, for exposed concrete it has been suggested by ACI Committee 207 that because the interior concrete reacts so much slower than the exterior concrete to ambient temperature cycles, it as though the surface concrete is completely restrained by the interior concrete. ^[2] Temperature measurements inside a concrete dam in France show that the distance between isothermic lines decreases near the concrete surface. This is illustrated in Figure 3.4. ^[20] The spacing of the isothermic lines indicates the gradient is steepest at the concrete surface and explains why thermal cracks are generally

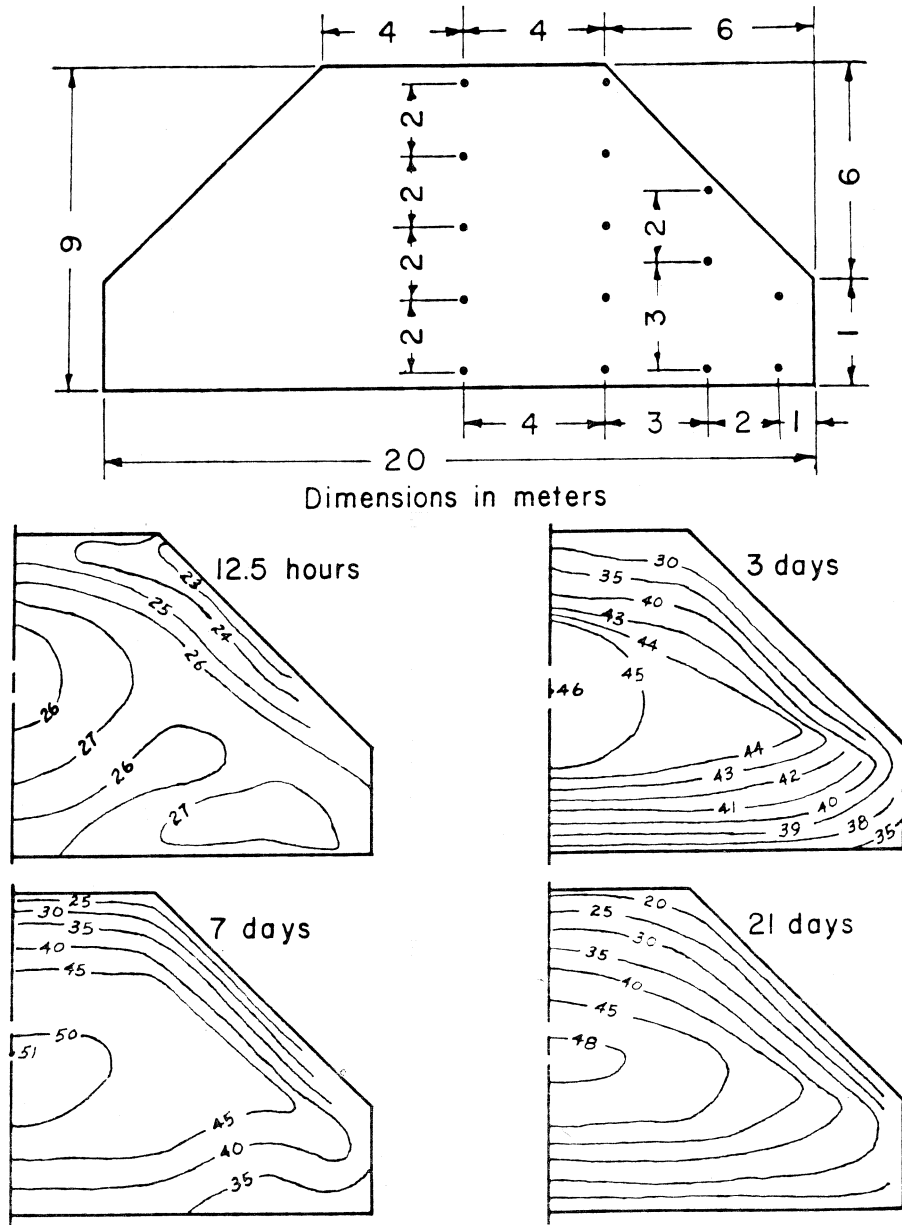

Figure 3.4 Isothermic curves in deg. C for horizontal section of a concrete buttress head for various ages. [20]

shallow. The cracked surface concrete does, however, protect the integrity of the member by insulating the interior concrete from rapid temperature changes.

It is important to understand that high early temperatures that may develop prior to final set are not significant because the thermal stresses are small due to the low elastic modulus and high creep of concrete at early ages. Thermal cracking is more prevalent upon heating or cooling of the hardened concrete. Bamforth has shown that while fly ash may reduce the temperature rise, fly ash concrete may be as susceptible to thermal cracking as plain concrete due to the fly ash concrete's higher E_c/f'_c ratio at early ages. [17]

Many of the thermal cracking considerations, excluding those for mass concrete, are based on rule of thumb approximations. A temperature drop of 45° F appears to be a reasonable limit to that which unreinforced concrete can withstand without cracking. [12] The temperature drop limit of 45° F was simply chosen because in one field study concrete foundations which cracked experienced that temperature drop. [19] ACI Committee 207 recommends that the maximum temperature drop be limited to 25 to 35° F (14 to 20° C). [2] The validity of such rules of thumb are questionable. What the maximum temperature drop limit should be is debatable, but common assumptions of the thermal gradient often are very inaccurate. The thermal gradients shown in Figures 3.1 and 3.4 definitely prove that the commonly assumed linear temperature gradient from the ambient temperature at the concrete surface to the mid-depth temperature in a member can be very unconservative in estimating the gradient produced by hydration.

The determination of the maximum temperature drop concrete can withstand is not totally based on rules of thumb as shown in Figure 3.5. Figure 3.5 provides a graphical determination of the maximum allowable temperature drop for concrete cast in cold weather.

The primary method of limiting the temperature rise in concrete has been to limit the amount of cement in the mix. That is often done by replacing a portion of the cement with a pozzolan, particularly fly ash, because most pozzolans reduce the temperature rise by delaying and reducing the heat evolved from hydration. The amount of heat reduction has been studied but it is difficult to compare results because of the many variables involved which affect the concrete temperature such as cement type, fly ash type, initial concrete temperature, sample size, and sample environment. The most quoted study on the potential reduction in the temperature rise in concrete with the addition of fly ash is by Davis in 1937. [1] Davis found that the percentage reduction

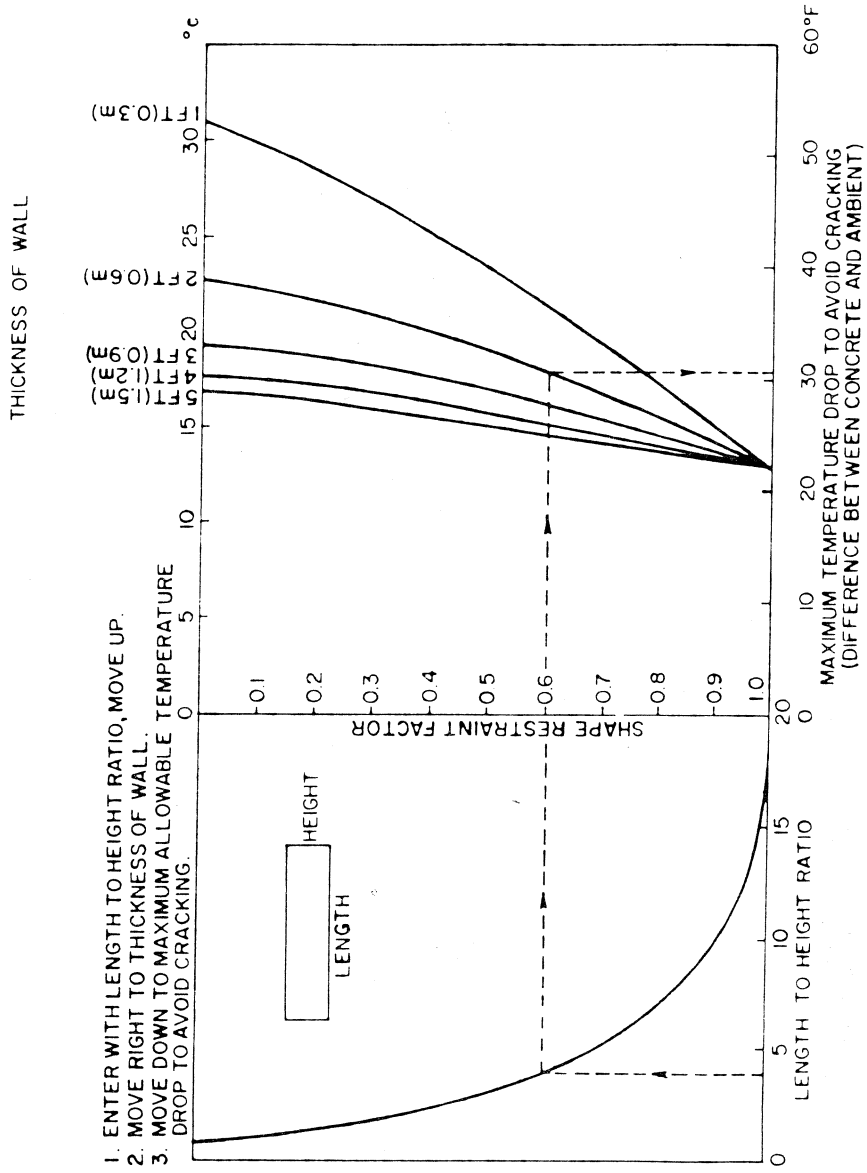

1. ENTER WITH LENGTH TO HEIGHT RATIO, MOVE UP.
2. MOVE RIGHT TO THICKNESS OF WALL.
3. MOVE DOWN TO MAXIMUM ALLOWABLE TEMPERATURE DROP TO AVOID CRACKING.

Figure 3.5 Graphical determination of safe concrete form stripping temperature. [21]

in the heat of hydration up to 28 days is roughly one-half of the percentage of fly ash replacement. ACI 211.1-81 states that the early age heat contribution of a pozzolan may be conservatively estimated at between 15 to 50 percent that of the equivalent weight of cement. [22]

The above stated reductions in the rate of temperature rise and peak temperature are reasonable for low calcium fly ashes (generally Texas SDHPT Type A) but may not be accurate for high calcium fly ashes (Texas SDHPT Type B). Early strength is usually proportional to heat generated at early ages and some high calcium fly ashes produce strength and heat at a rate similar to cement as shown in Figures 3.6 and 3.8. [3]

Other research done on mass concrete has also shown that the effect of fly ash in lowering the peak temperature is reduced as the casting volume is increased. [17] The implication of that size factor is that as the concrete environment becomes more nearly adiabatic, the total heat generated predominates over the rate of heat generation in determining the peak temperature. In other words, the rate of heat generation predominates as the rate of heat loss increases. The decrease in the effectiveness of fly ash in decreasing the peak temperature as the casting volume increases indicates that fly ash hydrates at a slower rate than cement but may produce nearly the same amount of heat over a period of days.

When the peak concrete temperature will occur is also an important parameter in thermal cracking. In order to minimize the temperature gradient in the concrete, the time of casting and the concrete mix design should be determined such that the peak concrete temperature does not occur at the same time as the low air temperature for the day. That is especially important for surfaces exposed to the environment.

Exposed concrete surfaces gain heat not only from the hydration of cement and fly ash but also from solar radiation. A study in Great Britain showed that sunshine and high air temperatures caused cracking of a concrete roadway. [23] In that study, it was found that the cracking was primarily observed in the roadway cast in the morning. The intensity of cracking was proportional to the maximum day temperature as shown in Figure 3.7. The proposed reason for the cracking of the slabs cast in the morning is that those slabs developed a greater temperature because of their longer exposure to the sun. The higher concrete temperature resulted in a greater drop of the surface concrete temperature when exposed to the lower night time temperatures, thus a greater temperature gradient developed in the concrete.

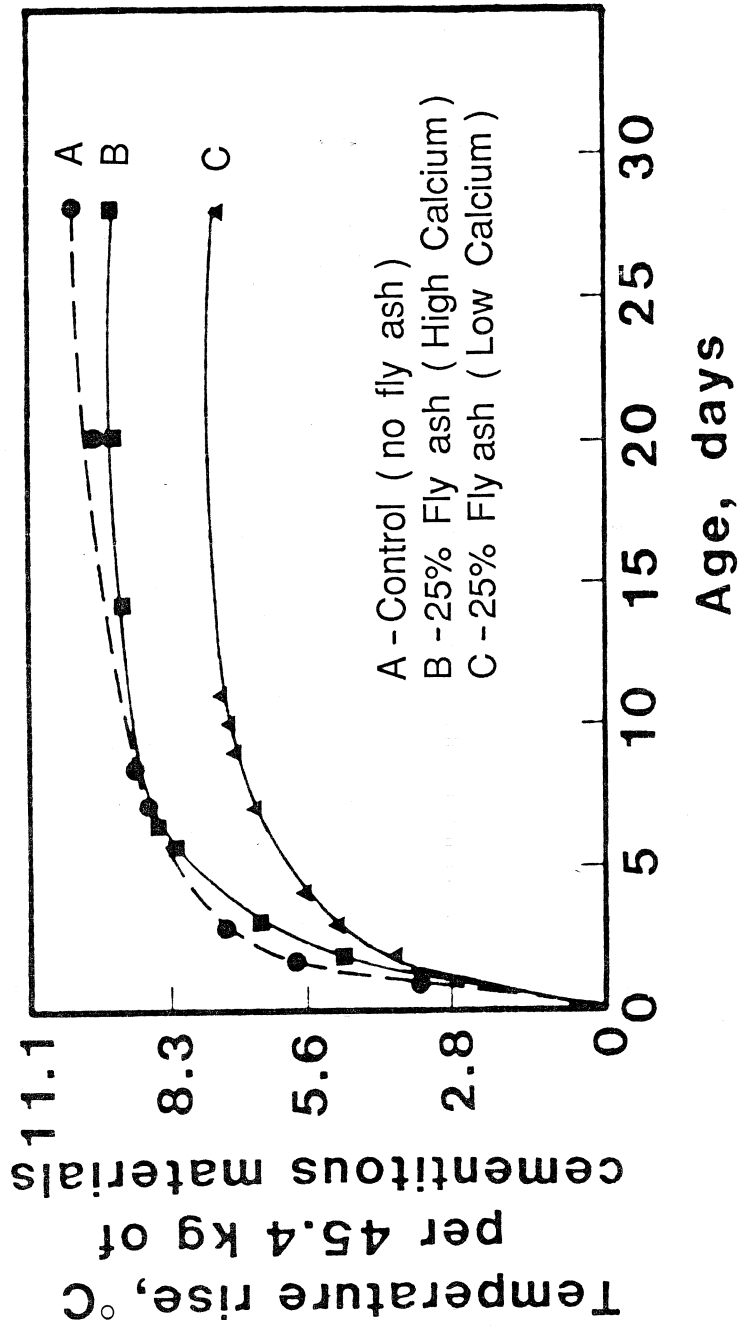

Figure 3.6 Adiabatic temperature rise in concrete containing high calcium fly ash. [3]

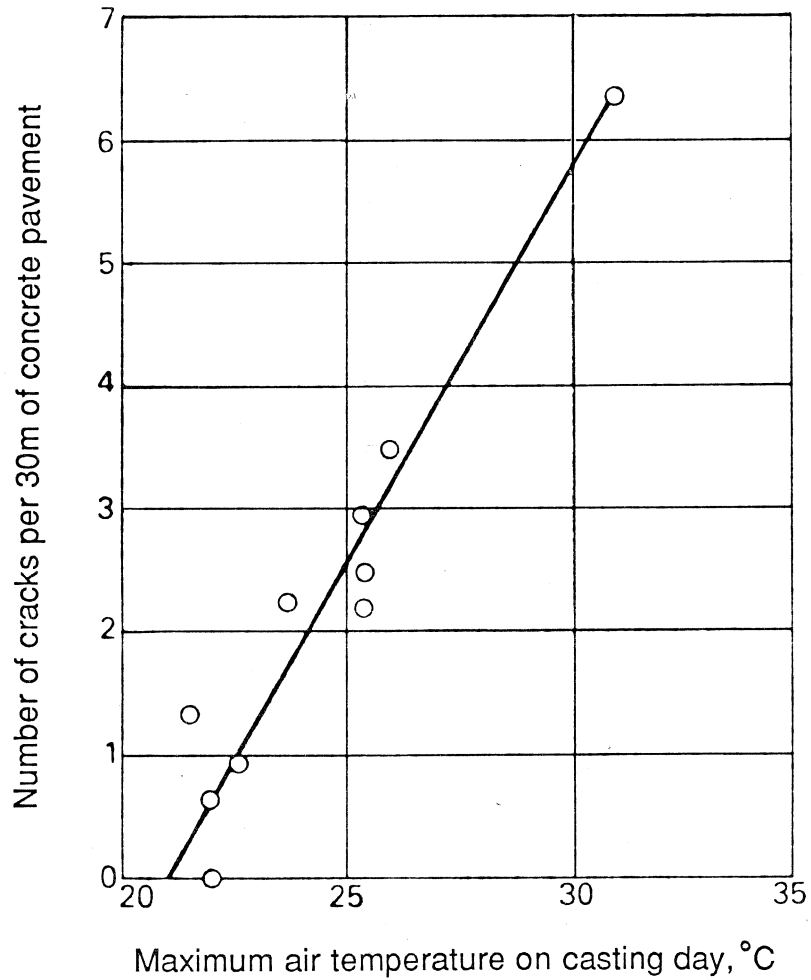

Figure 3.7 Number of Cracks per 30m of Day's Work vs. Maximum Air Temperature on Casting Day during construction of a concrete road in Great Britain. [23]

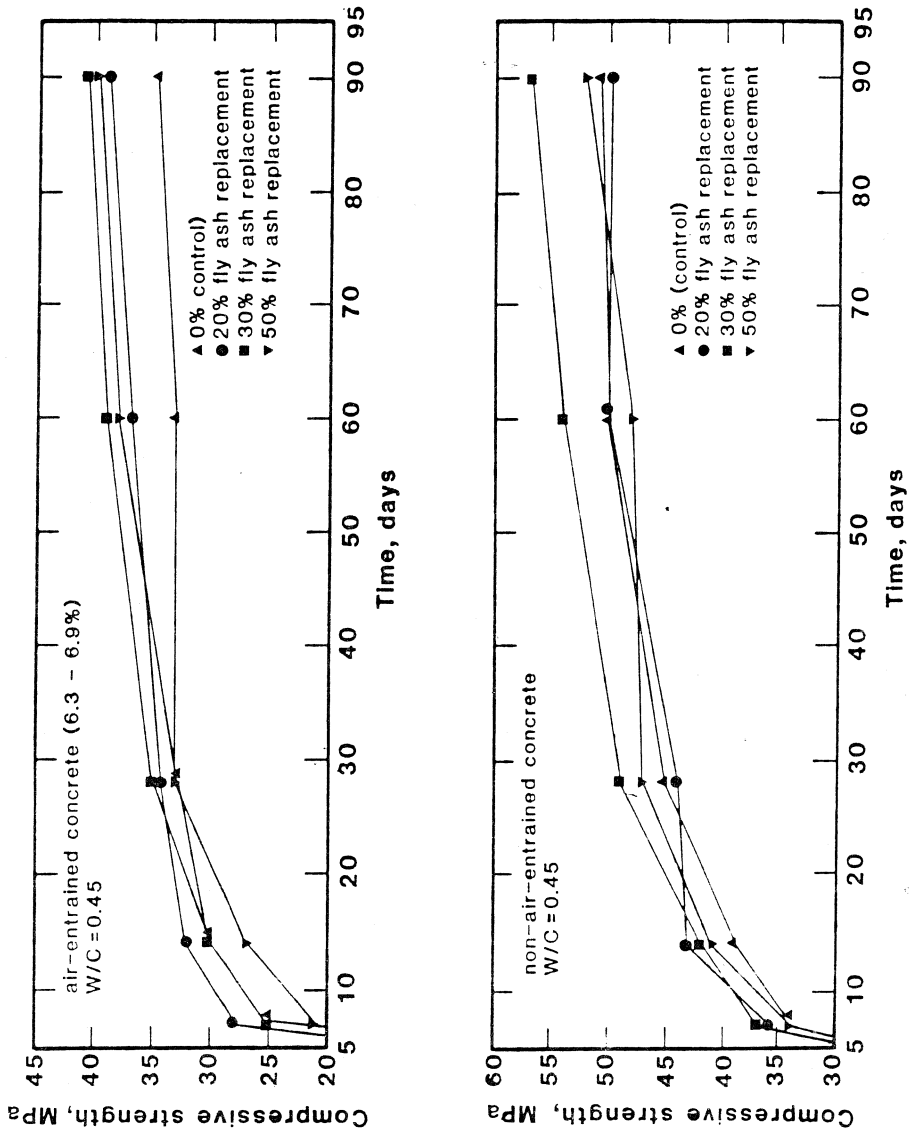

Figure 3.8 Compressive strength development of concretes containing high calcium fly ash. [3]

3.3 Strength of Fly Ash Concrete

It is difficult to summarize the vast amount of research published on the effect of fly ash on the compressive strength of concrete and mortar. [1, 3, 6, 8, 10, 12, 13, 14, 24, 25, 26, 27, 28] Compressive strength is dependent on the fly ash properties (chemical and physical), cement type, method of fly ash addition, and mix proportions. Researchers do, however, generally agree that no single property of the fly ash can be used to predict its contribution to strength. Researchers also agree that the addition of fly ash decreases early strength, and that the strength development of fly ash concretes is more dependent on curing conditions than ordinary Portland cement concretes.

Studies have shown that high calcium fly ashes will produce higher strength concretes and mortars at early ages than low calcium fly ashes due to the additional cementitious properties associated with the higher calcium content. [3] Conversely, research by Smith [24] suggested that there is no relationship between the chemical or physical properties of a fly ash and its cementing efficiency. Smith's fly ash cementing efficiency factors appear to be more dependent on the cement type than fly ash type. This is probably due to the fact that the percentage loss in early strength due to fly ash addition is generally greater for fast reacting cements than for slow cements. Additionally, different fly ashes produce mortars that develop strengths at different rates. [6] Thus the ranking of fly ashes at early ages by compressive strength may not be the same as at later ages as shown in Figure 3.8.

It is generally accepted that fly ash increases the strength of concrete at ages greater than 3 to 6 months when replacement is made on a one - to - one basis (by weight or volume). This strength increase is due to the pore filling quality of the pozzolanic reaction.

The strength of fly ash concretes and mortars are more dependent on the curing temperature than mixes without fly ash. [3,28,29] The ultimate strength of mixes with fly ash increase with increasing temperature whereas mixes with Portland cement decrease with temperatures in the range associated with mass or hot weather concreting. [28]

3.4 Workability of Fly Ash Concrete

It is well known that the partial replacement of cement by most fly ashes improves the workability of concrete and the flow of mortar. The generally accepted

reason for that increase in workability is that the smooth, spherical fly ash particles act analogously to ball-bearings in the fresh concrete. Similarly, the workability of concrete increases with the smoothness and roundness of the coarse aggregate.

Recent research by Helmuth presents a strong argument contradictory to the long-standing ball-bearing analogy. ^[30] The new hypothesis is that replacement of cement with fly ash decreases the mix water requirement for a given workability because the very fine fly ash particles adhere to the surface of the cement particles. The negatively charged fly ash particles adhere to the positively charged regions of the calcium silicates. If enough of the individual cement particle area is covered (positively charged areas neutralized), the negatively charged regions of the cement particle will repel similarly coated, negatively charged cement particles. Thus, fly ash is believed to act much like a chemical dispersant such as superplasticizer (high-range water reducer).

The dispersant analogy for the improved workability with fly ash is supported by the following findings:

- 1) Particle shape has a limited effect in the range of cement particle sizes where surface charge effects dominate. The analogy between round, smooth fly ash particles and round, smooth coarse aggregate is not valid.
- 2) The greatest reduction in mixing water required to maintain a given flow resulting from the partial replacement of cement with fly ash occurs with fly ashes of the highest specific surface areas. This is contrary to the increased water requirement associated with increased cement fineness.
- 3) Chemical composition of the fly ash appears to have little effect on the flow of mortar.
- 4) The mixing water requirement does not steadily decrease with increasing fly ash content as would be expected from the ball-bearing analogy. ^[30] Examples of mortars that did not show a steady increase in flow with an increase in fly ash content are presented in Figure 3.9 and the properties of those fly ashes are listed in Table 3.2. The trend shown in Figure 3.9 is not in agreement with the trend of increasing flow with increasing fly ash content (up to 30 percent by weight) reported by the Texas Transportation Institute. ^[15]

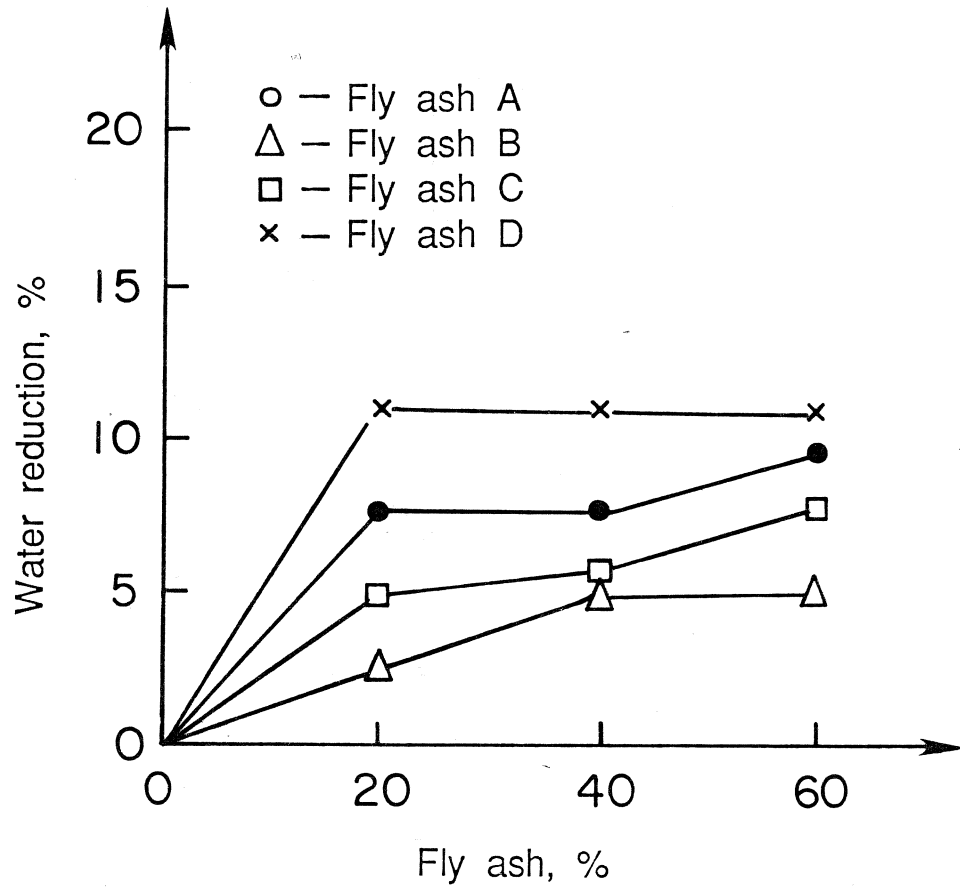

Figure 3.9 Water reduction in mortar vs. fly ash replacement of Portland cement. [30]
Selected properties of the fly ashes are in Table 3.2.

Table 3.2 Various properties for fly ashes presented in Figure 3.9 [30]

Fly Ash	Specific Gravity	Blaine Specific Surface Area m^2/kg	Blaine Specific Surface Area $\text{m}^2/\text{m}^3 \times 10^3$	Water Retained, %			L.O.I. %	CaO %	SO ₃ %
				No. 325 Sieve	No. 200 Sieve	No. 100 Sieve			
A	2.59	306	793	7.4	2.5	1.66	0.5	1.28	
B	2.32	223	517	17.7	9.8	0.85	10.46	0.23	
C	2.29	196	448	18.3	8.5	2.20	0.5	0.70	
D	2.89	279	806	7.8	3.3	0.40	29.1	8.50	

3.5 The Effect of Chemical Admixtures on the Hydration of Portland Cement

3.5.1 Water Reducers/Retarders. A water reducer can be defined as an admixture which reduces the amount of mixing water in concrete needed to achieve a particular workability. The reduction in mixing water for commercial water reducers is generally in the range of 5 to 15 percent.

An admixture which lengthens the setting time of concrete is referred to as a retarder. Water reducers which also increase the setting time of concrete are called water reducers/retarders. This combination of effects is common because many of the commercial water reducers and retarders have some of the same ingredients. A point to note on retarders is that researchers use both the increased set time and the decreased degree of hydration as measures of retardation. Those two items are related, but not the same.

Cement particles tend to flocculate when mixed with water. Water reducers cause the clusters of cement particles to break into individual cement particles. The increased mobility of cement particles in the presence of a water reducer is believed to be the result of one or a combination of the following:

- 1) the reduction in attraction between particles
- 2) the release of water trapped in the cement flocs
- 3) the coating of cement particles by water molecules. ^[31]

Water reducers/retarders affect the temperature development in concrete primarily by delaying the period of rapid hydration. While early hydration is delayed by the retarder, the total heat generated (as measured 38 days later) may be unchanged or increased. ^[31]

The chemical or physical mechanism by which water reducers (such as the lignosulfate based one used in this study) affect hydration is not clear. Studies have shown conflicting results of the effects of lignosulfates on the very early age hydration period (2 to 3 hours after mixing). It has been observed that lignosulfates can retard or accelerate the very early hydration of cement. ^[31] Both observations may be correct because of the great number of parameters that may have an influence.

The addition of lignosulfate significantly retards hydration of cement from 3 hours to 1 day after mixing. The retardation of hydration in that time period is

due to the retardation of C_3S and C_3A . The lignosulfate concentration in the liquid phase retards the reaction of C_3S and water. The hydration of C_3A is delayed because of the retardation of the conversion of ettringite to monosulfate. That retardation of ettringite is believed to be due to the absorption of the organic lignosulfate molecules by ettringite. ^[31] The retardation of the hydration of cement and fly ash in the presence of lignosulfonate is shown in Figures 3.10 and 3.11.

3.5.2 Superplasticizers. The addition of superplasticizers to concrete can reduce the mixing water in concrete by 20 to 30 percent. For that reason superplasticizers are also referred to as high-range water reducers. Superplasticizers are classified as three main types: sulfonated melamine formaldehyde condensates, lignosulfates, and sulfonated naphthalene formaldehyde condensates. Each superplasticizer type causes cement particles to disperse but by different mechanisms. It is believed that melamine based superplasticizers form a lubricating film on the cement particles and lignosulfates decrease the surface tension of the mixing water. The superplasticizer used in this study is a naphthalene. Naphthalene molecules carry a negative charge, and when absorbed on the surface of a cement particle the cement particle becomes negatively charged. The similarly charged cement particles repel each other causing them to disperse. ^[33,34] Figure 3.12 provides a schematic representation of the dispersion of cement flocs in the presence of a superplasticizer.

It is difficult to summarize the effect of superplasticizers on the hydration of cement because the effect varies not only with the admixture type and dosage rate but also with the cement composition and the water to solid ratio. It is generally agreed, however, that naphthalene based superplasticizers retard the reaction of C_3A (which occurs early) by retarding the conversion of ettringite to monosulfate. A retardation of C_3S has also been noted. ^[31]

The result of the addition of a naphthalene based superplasticizer to cement paste is an initial acceleration of hydration (first 10 minutes) followed by a retardation of hydration through the early and middle stages (stages 2-4 described in Chapter 2). ^[35] A similar retardation was found for cement paste and naphthalene hydrated at a constant 25°C. ^[36] As the ambient temperature was raised from 25 to 40°C, paste containing naphthalene had a larger increase in heat evolution over the first 36 hours than naphthalene free paste. The temperature sensitivity of the naphthalene superplasticizer and cement system may indicate that the retardation of hydration with the addition of

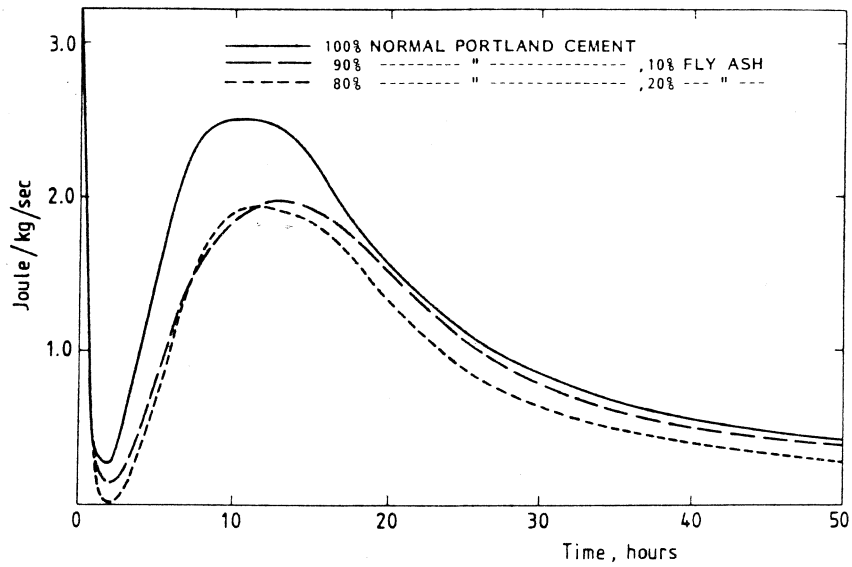

Figure 3.10 Heat evolution curves of Portland cement and fly ash. [32]

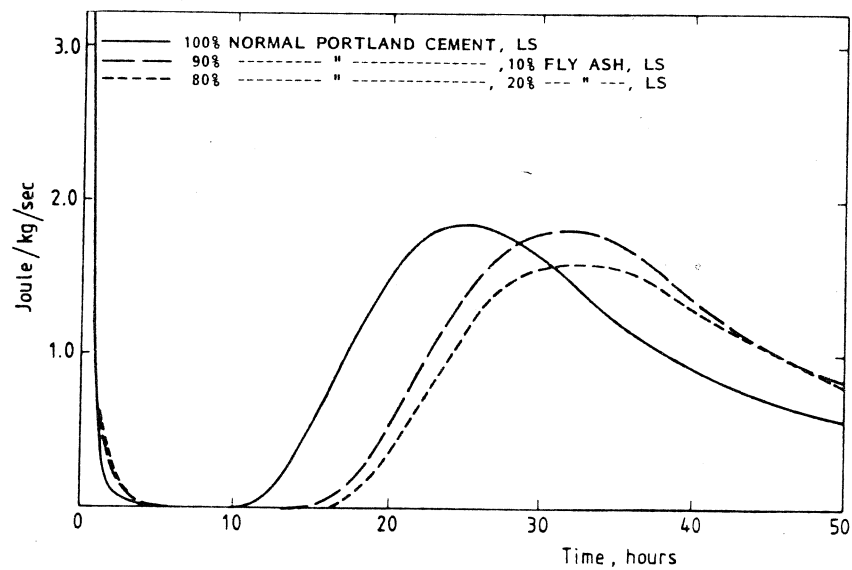

Figure 3.11 Heat evolution curves of Portland cement and fly ash, with lignosulfonate addition. [32]

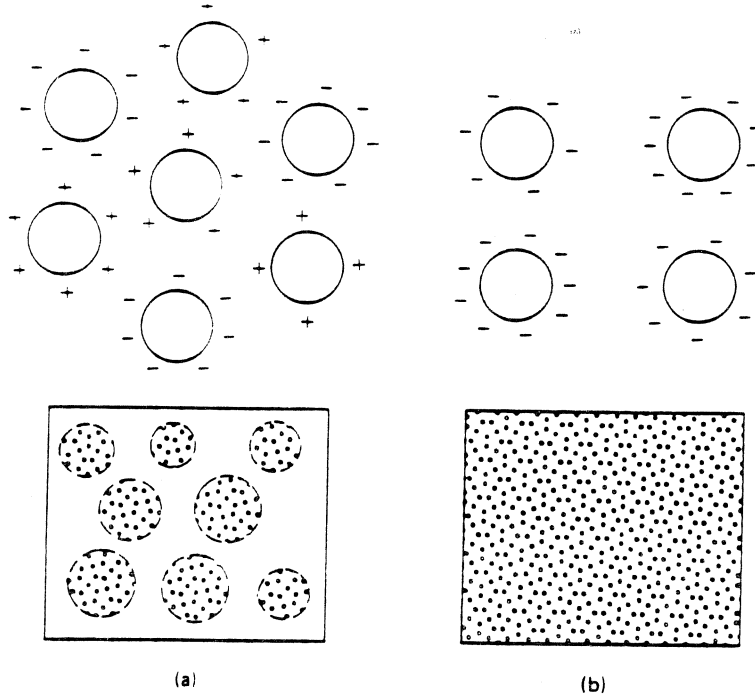

Figure 3.12 Dispersing action of superplasticizer (schematic representation) : a) flocculated paste ; b) dispersed paste. [8]

superplasticizer may not be as pronounced under the high temperatures developed in nearly adiabatic conditions.

It is generally agreed that superplasticizers increase the 28 day compressive strength of concrete even if the mixing water is not reduced. That increase is attributed to a greater degree of hydration associated with the dispersion of cement particles. An increase in strength may not be realized if the superplasticizer entrains additional air.

CHAPTER 4

EXPERIMENTAL WORK

4.1 Introduction

The experimental work in this study was divided into two main areas. One area of work involved monitoring the temperature gradient for concrete samples cast under laboratory and field conditions. The four temperature gradient tests are labeled as Test 1 to Test 4.

The other area of work was an investigation of the effect of fly ash on the temperature rise in mortar. Along with monitoring the internal mortar temperature, strength and flow tests were conducted to provide a comparison of mortars based on compressive strength and workability.

The effect of fly ash on the temperature rise in concrete was studied by monitoring the temperature in mortar samples in nearly adiabatic conditions. A higher mortar temperature correlates to a higher concrete temperature because heat is generated by reactions occurring in the paste. The reasons for using mortar instead of concrete are:

- 1) For small samples the placement of the thermocouple relative to the coarse aggregate may cause erroneous readings.
- 2) The specific heat and thermal conductance (if not adiabatic conditions) of the coarse aggregate have a great affect on the concrete temperature rise. By not using coarse aggregate the number of test variables is reduced.

Mortar was used instead of paste so that the same batch could be used for temperature rise tests, compressive strength tests, and flow tests.

4.2 Temperature Gradient Tests

4.2.1 Testing Equipment. The temperature rise with time in the concrete samples was measured using J-type thermocouples (iron- constantan). The thermocouple wire was Omega Engineering Inc.'s type FF-J which has a manufacturer's stated accuracy of +/- 4°F (2.2°C) and a resistance of 0.357 ohms per double foot at 68°F.

The thermocouples were connected to a Fluke Helios - I Computer Front End. The computer front end continuously monitored the voltage across each thermocouple and converted the voltages to degrees Fahrenheit. The manufacturer's stated accuracy for data acquisition by the Helios - I with J-type thermocouples is +/- 0.63°F (0.35°C).

The Helios - I executes commands from a host computer. After converting the voltages to degrees, the temperatures were stored in the random access memory of the host computer.

4.2.2 Test 1. Test 1 involved the measurement of the internal temperature of mass concrete cast indoors. The mass concrete sample was 4 ft x 3 ft 10.5 in. x 4 ft, which will be referred to as a 4 ft cube for the remainder of this report. The formwork, which was kept on for the duration of the test, consisted of 3/4 in. plywood lined with plastic. The formwork was secured to the top of a pallet. J- type thermocouples were secured in the concrete by attaching them along fishing line. The fishing line was run through the bottom of the formwork and secured above the eventual finished concrete surface. By taking care not to chute the ready mixed concrete directly into the thermocouple lines, the thermocouples moved only slightly from their intended position. Figure 4.1 provides an illustration of the concrete sample and thermocouple locations within the sample.

A five sack ready mixed concrete with a W/C ratio of 0.49 by weight and retarder was used. The slump was 3 inches. The mix proportions for the ready mixed concrete used in Tests 1, 2, 3 and 4 are shown in Table A.1 in Appendix A.

The concrete was compacted by internal vibration and placed in four lifts.

The only reinforcing steel in the mass concrete was two 15 in. U-shaped bent bars placed in diagonally opposite corners. The stirrups were used in lifting the 4 ft cube after testing was completed.

4.2.3 Test 2. The same equipment and procedures were used in Test 2 as in Test 1. The 4 ft cube was cast with the same concrete mix design and the concrete was ordered from the same ready mix batch plant as the Test 1 concrete. Unlike Test 1, the Test 2 concrete contained no entrained air. The slump was 6.25 inches.

4.2.4 Test 3. Test 3 involved the measurement of the internal temperature of concrete beams cast outdoors. The beams were cast in the standard 6 in. x 6 in. x 20 in. steel molds used for flexural strength tests. Sixteen such beams were cast and eight placed in each of two insulated boxes. The insulated boxes consisted of a 3/4 in. plywood interior wall, a 3 in. gap filled with fiber-glass insulation, and a 1/4 in. plywood exterior wall. A similar arrangement of insulation and plywood provided a base for each insulated box. The interior dimensions of the boxes were such that the beam molds butted together. The tight placement of beams was an attempt to decrease the air circulation between the molds. The molds were placed on top of black plastic

TEST 1 AND TEST 2

Figure 4.1 Dimensions and thermocouple locations for samples used in Test 1 and Test 2.

spread over both boxes. The two insulated boxes were placed side-by-side outdoors on a concrete slab free of shadows.

Thermocouples (J-Type) were placed in the center of one beam per each group of eight beams. The thermocouple depths were 4 in., 3 in., 2 in., and at the concrete surface. In one insulated box the top surface of each beam was covered with damp burlap and black plastic. In the other box the beams were left exposed. Figure 4.2 provides an illustration of the placement of the beam molds in an insulated box, and the thermocouple locations within a beam.

A five sack ready mixed concrete with a W/C ratio of 0.38 by weight and retarder was used. The slump was 1 inch. That mix was chosen to provide concrete that would be very susceptible to plastic shrinkage cracking. Unfortunately, the results of flexural tests to measure surface cracking were meaningless because the low slump concrete was difficult to finish to a smooth surface partially due to evaporation and decreased set time. That difficulty in finishing did, however, provide a first-hand experience with the problems associated with hot weather concreting.

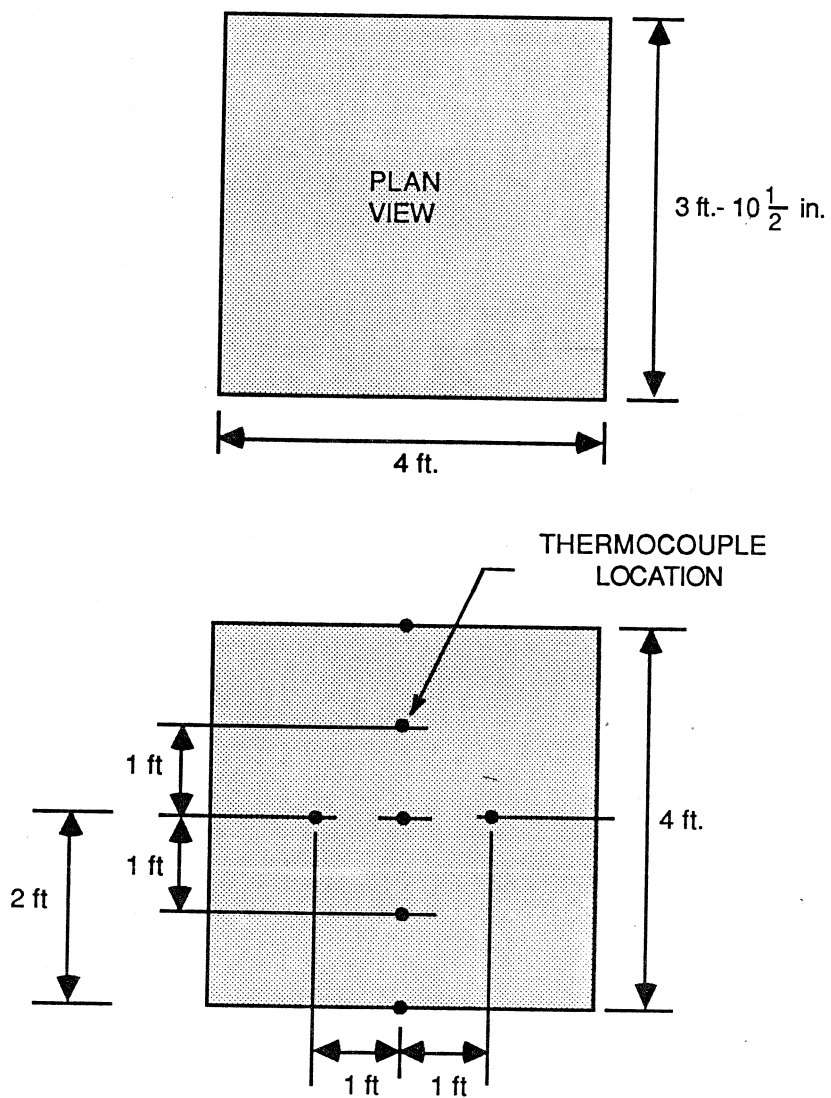
The beams were cast at 12 PM on September 11 when the air temperature was 98° F with a relative humidity of 42 percent. The initial concrete temperature was 90° F.

4.2.5 Test 4. Test 4 was conducted to measure the temperature gradient along the vertical cross section of concrete cast outdoors. Two samples were monitored : one with an exposed top surface and one with the top surface covered with damp burlap and plastic.

The two concrete samples were 74 in.x 30 in.x 18 in.. The vertical temperature gradient was measured along the 18 in. dimension. The forms were constructed of 3/4 in. plywood with 2 x 4 in. stiffeners. The forms were placed where they would be free of shadows. The J-type thermocouples were secured in the same manner as in Tests 1 and 2, and located as shown in Figure 4.3.

A 5.5 sack concrete mix with a W/C ratio of 0.41 and no retarder was used. The slump was 2.5 inches. The concrete was directly chuted into the forms and compacted by internal vibration. A #3 stirrup was placed in each corner of the top surface for lifting after testing.

The samples were cast at 1:10 PM on October 30 under partly sunny skies. The air temperature was 83° F and the initial concrete temperature was 83° F. October

TEST 3

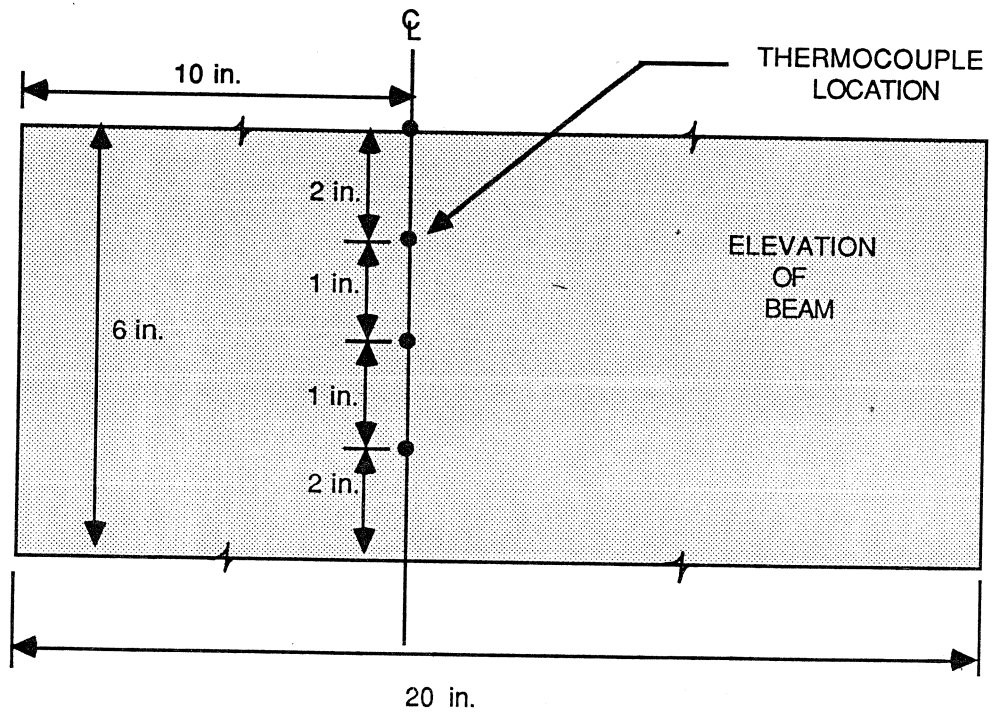
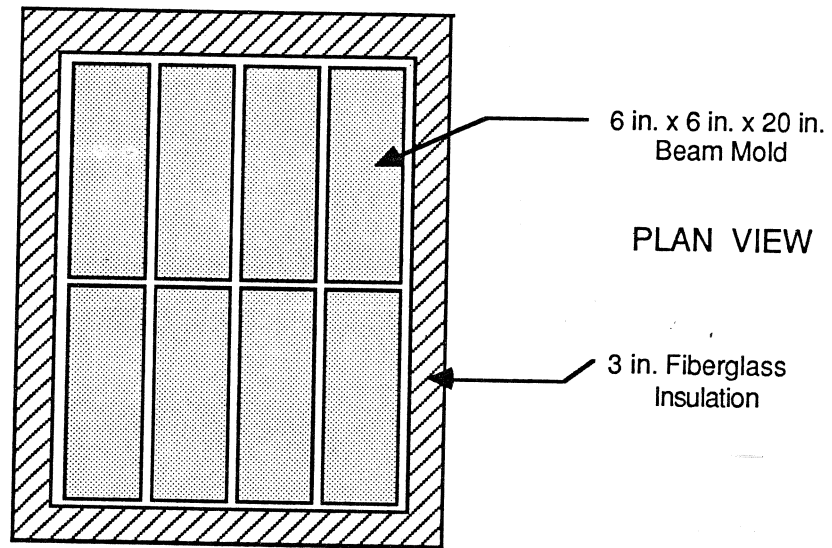

Figure 4.2 Dimensions and thermocouple locations for the samples used in Test 3.

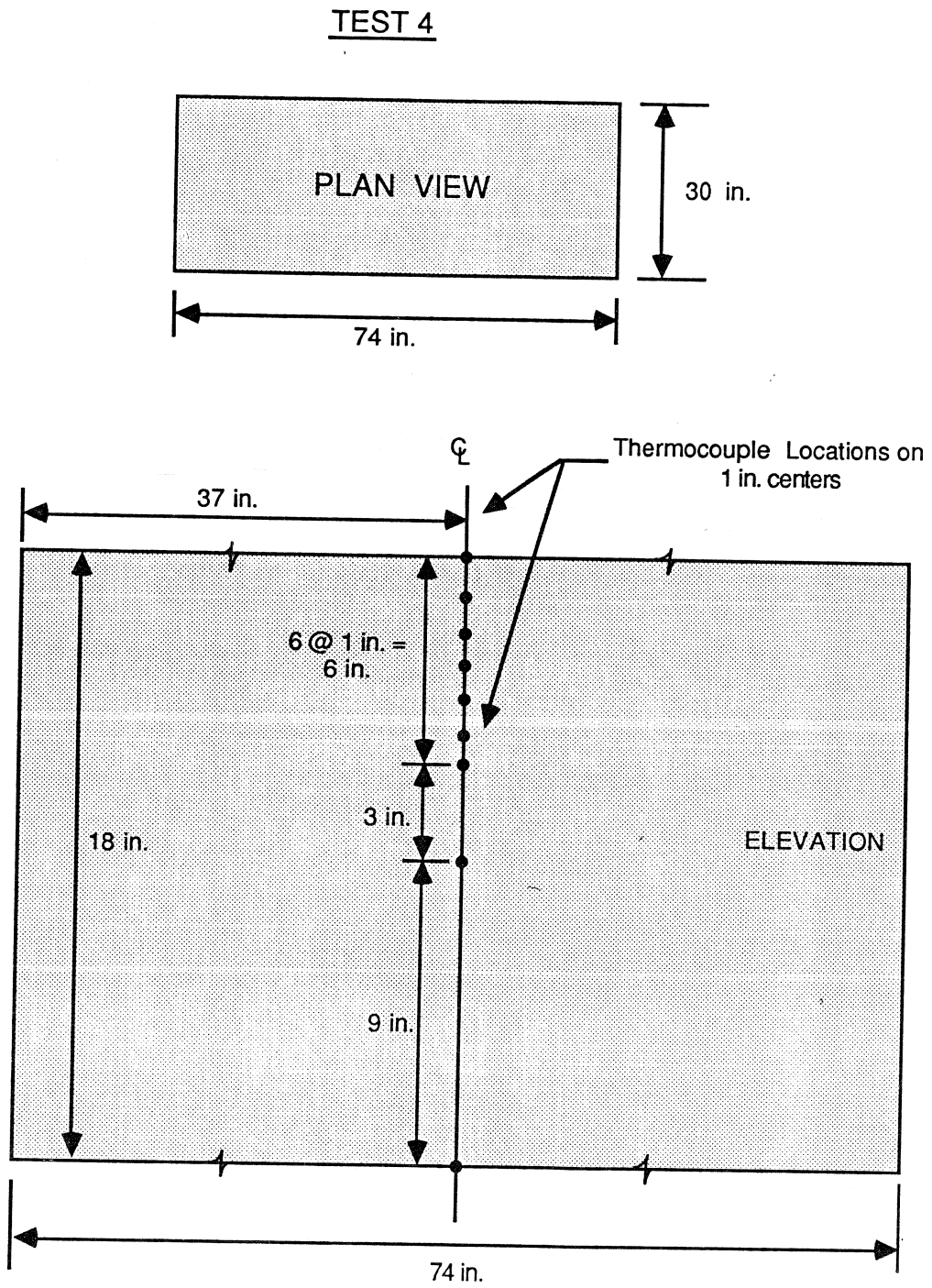

Figure 4.3 Dimensions and thermocouple locations for the samples used in Test 4.

31 was clear and sunny all day. Throughout October 30 and 31 it was very breezy with wind speeds of 15-20 mph as reported by the local weather service.

4.3 Temperature Rise in Mortar Samples

4.3.1 Test Setup. The type of thermocouple, wire, and data acquisition equipment used in the temperature gradient tests was also used to measure the temperature rise in mortar.

The mortar samples were placed in insulated boxes to reduce the heat lost to the atmosphere. The insulated boxes consisted of 2 pound per cubic foot density polyurethane foam cast around a standard 6 in. diameter plastic cylinder mold. The test mortar was placed in the plastic cylinder. Because the foam was cast from its liquid components and allowed to rise in a cardboard box around the plastic cylinder, the cylinder fit was very snug within the insulation. Each cylinder was surrounded by a minimum insulation thickness of 5 inches.

After casting the insulated boxes, cylindrical plugs (top insulation) were cast from the liquid components of polyurethane and allowed to rise in the 6 in. plastic cylinders. That foam was removed from the plastic cylinders and cut into 7.5 in. long solid foam cylinders. Those 7.5 in. solid foam cylinders were then used as plugs for the mortar samples by sliding the match-cast foam cylinders into the plastic cylinders containing the mortar samples. The mortar samples filled the cylinders to approximately mid-height (6 in.). The thermocouples were threaded through small holes drilled through the center of the plugs and embedded mid-depth into the mortar. Heat loss was minimized through those holes by adding additional foam and covering the holes with duct tape. A cut-away view of one such insulated box and plug is shown in Figure 4.4.

4.3.2 Materials. The cements, fly ashes, and admixtures used in this study are commercially available throughout Texas and provide a basis for comparison of physical and chemical properties of cements, fly ashes, and chemical admixtures in general. However, it should be noted that other cements, fly ashes, and chemical admixtures may produce different results.

The fly ashes used in this study were all produced in Texas and approved by the Texas SDHPT. The fly ashes are designated by letter without reference to producer. The abbreviation FA B denotes fly ash B, and not a Type B fly ash. Fly ashes A and B are Type A fly ashes. Fly ashes C and D are Type B fly ashes. The chemical compositions of the fly ashes used in this study are listed in Tables A.2 to A.5 in Appendix A.

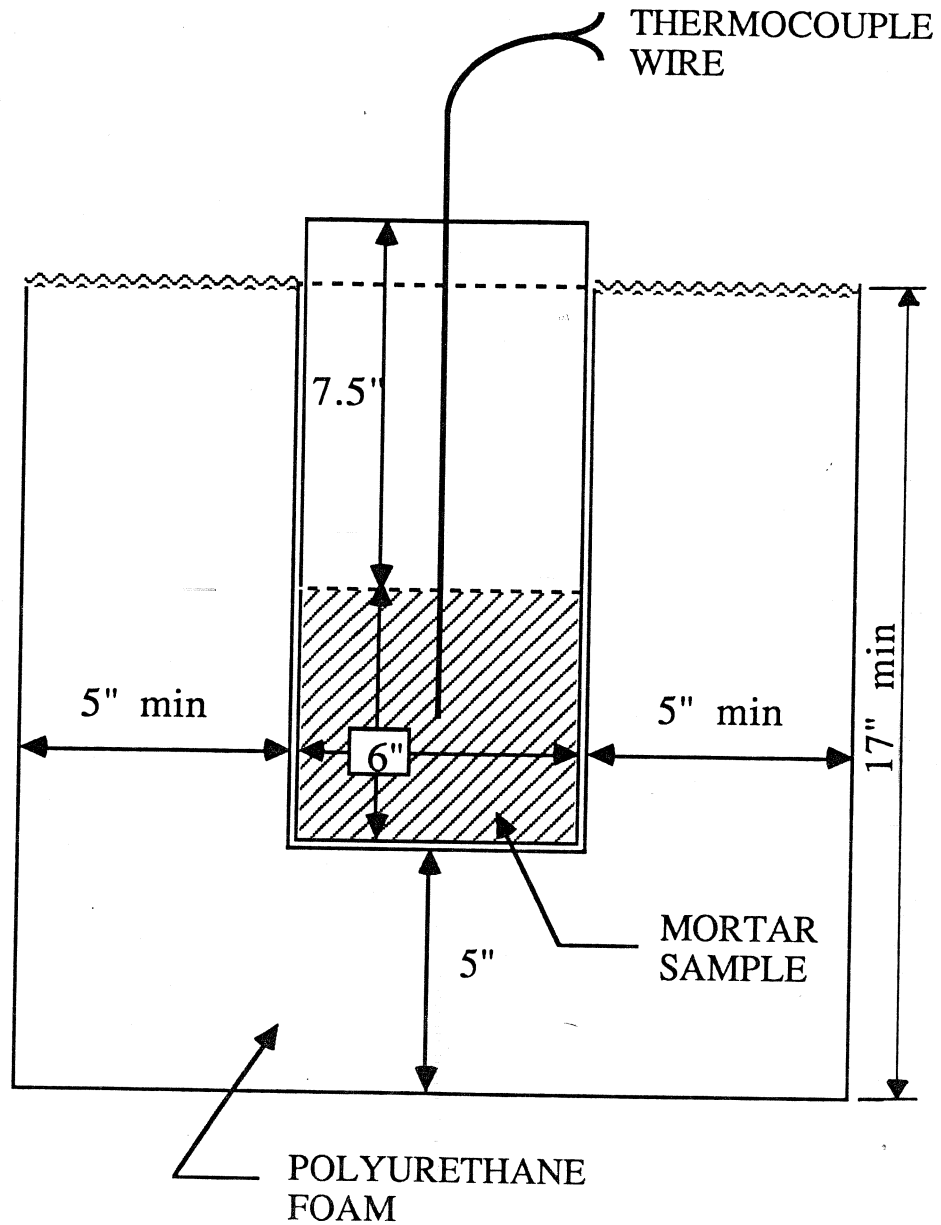

Figure 4.4 Mortar sample insulated by polyurethane foam. Plastic cylinder containing mortar is sealed with a 7.5" deep cylindrical foam plug.

Three cement types were used. Those three types meet the ASTM specifications for a Type I, a Type I-II, and a Type III cement. All three cements were manufactured in Texas. The results of the mill reports are presented in Tables A.6 to A.8 in Appendix A.

Two slightly different sands were used in this study. Both were Colorado River sands from the Austin, Tx area and distributed by the same aggregate firm. The properties of both the sands (labeled A and B) are presented in Tables A.9 and A.10 in Appendix A. The first letter in the mortar mix designation denotes the particular sand used.

The mixing water used in the mortar was potable tap water from Austin, Tx.

The retarder/water reducer used in this study meets the requirements of ASTM C494. ^[37] The retarder/water reducer is lignosulfonate based. The manufacturer's recommended dosage is 4 +/- 1 fluid ounce per 100 pounds (oz/cwt) of cement for concrete. Mortar mixes containing retarder are designated by the letter R.

The superplasticizer used also meets the requirements of ASTM C494. The superplasticizer is an anionic naphthalene based material with a manufacturer's recommended dosage of 6 to 12 oz/cwt of cement for concrete. Mortar mixes containing superplasticizer are designated by the letter S.

4.3.3 Mortar Mix Proportions. In this study, the composition of the basic mortar mixes (all mixes except those in which the cement content is varied) is one part cement to 2.75 parts of sand by weight as outlined in ASTM C109 Standard Test Method for Compressive Strength of Hydraulic Cement Mortars. ^[38] The standard proportions in ASTM C109 were modified in this study as follows :

- 1) Cement was replaced by fly ash on an equal volume basis. Because the specific gravities of the fly ashes used in this study are not the same as cement, the sand to cementitious material (cement and fly ash which is abbreviated as C+FA) ratio is constant by volume not by weight.
- 2) The water to cementitious material ratio by weight ($W / (C+FA)$) was decreased below the ASTM C109 standard of 0.485 to 0.467 to offset the increase in flow associated with the replacement of cement with fly ash. The $W/(C+FA)$ ratio was reduced to keep the mortar on the flow table. A similar reduction is specified in ASTM C109 to accommodate the increased flow provided by air-entraining agents. ASTM C109 specifies that the water be

reduced to produce a given flow for mortars containing admixtures other than air-entraining agents. That specification was not followed because the mixes were designed based on a constant $W/(C+FA)$ ratio, and not on a constant flow. Thus, the flow was allowed to vary.

The amount of mortar without fly ash used in a temperature rise sample was 12.5 pounds. For each sample the weight of sand and the sand to cementitious material ratio by volume was held constant. The total sample weight for mortars containing fly ash varied slightly due to the difference in specific gravities of cement and fly ash, and the differing amounts of mix water. Similarly the total sample volume varied slightly because the $W/(C+FA)$ ratio by weight was held constant and thus the volume of water varied. The percentage replacement of cement by fly ash is limited by the TSDHPT to 20 to 35 percent by volume. [39]

Tables A.11 to A.13 in Appendix A provide a listing of the mix ingredients on a unit volume basis. The air content was determined to be 2.6 percent using the following equation presented in ASTM C185 Standard Test Method for Air Content of Hydraulic mortars [40] :

$$\text{Air Content, volume \%} = 100 * [1 - (W_a/W_c)]$$

where :

W_a = actual weight per unit volume

W_c = theoretical weight per unit volume, calculated on an air free basis.

The actual density (W_a) was found to be 138.8 pounds per cubic foot for Type I-II cement mortar with a W/C ratio of 0.467 and no admixtures. The air free density (W_c) for the same mix was calculated to be 142.5 pounds per cubic foot. For proportioning, the air content was estimated as 3 percent for all the mixes.

4.3.4 Mixing Procedure. The mortar mixes used in temperature rise tests were mixed in a two cubic foot capacity rotary drum mixer. The following mix sequence was used:

- 1) Butter (coat) mixer with 10 percent of batch weights of sand, cement, and water. Mix for 3 minutes, then remove excess.

- 2) With mixer running, add sand, cement, fly ash, and water in that order. Chemical admixtures were added to the mix water before pouring into mixer. Stop mixer and scrape down sides and blades with a trowel.
- 3) Mix for 3 minutes.
- 4) Stop mixer and scrape down sides. Let mortar stand for 3 minutes with mixer covered with a damp but not dripping burlap cloth to prevent the evaporation of mixing water.
- 5) Resume mixing for 2 minutes.

The above mixing sequence is based on ASTM C270 Standard Specification for Unit Masonry ^[41] which states "all cementitious materials and aggregate shall be mixed between 3 and 5 minutes in a mechanical mixer". The relative times in the mix sequence are the same as specified in ASTM C305 Standard Method for Mechanical Mixing of Hydraulic Cement Pastes and Mortars for Plastic Consistency. ^[42]

4.4 Compressive Tests for Mortar

In this study, the mortar cubes were molded, cured, and tested according to ASTM C109 with the exception of the cubes exposed to elevated temperatures for the first 24 hours. The cubes cured at 97°F were formed in molds which were preheated in a 97°F environment prior to molding. After finishing the cubes, brass top plates were snugly tightened to the mortar surface. The molds were then immediately placed in plastic bags and placed in an environmental chamber which maintained an internal temperature of 97°F. Even with the top plates, plastic bags, and an environmental chamber relative humidity of 45 to 50 percent, the cubes experienced some drying. The extent of drying appeared uniform amongst the samples stored at elevated temperatures.

4.5 Flow Tests for Mortar

The flow tests were conducted as specified in ASTM C109. The ASTM flow test begins by forming a truncated cone of mortar on a circular flow table. The flow table is connected to a crank cam which is cranked by hand to drop the flow table through 0.5 inches, 25 times in 15 seconds. The flow of a mortar is the resulting increase in the base diameter of the mortar expressed as a percentage of the original diameter.

Because the $W/(C+FA)$ ratio was held constant, the flow varied with the mix ingredients and proportions. The flow was only monitored to provide a means of comparing the placeability of different mortars.

CHAPTER 5 TEST RESULTS

5.1 Introduction

The results of the experimental work conducted are presented in this chapter. The temperature rise data is presented in graphical form because of the large number of data points. The values corresponding to the peak temperature and the time to the peak temperature are also presented in tabular form in Appendix B.

The compressive strength and flow test results are provided in graphical form in this section and in tabular form in Appendix B.

In this section the test results are presented with no discussion of their significance. The test results and their significance are discussed in Chapter 6 and 7.

5.2 Data Reduction

5.2.1 Temperature Rise. The temperature rise curves shown on Figures 5.13 to 5.43 are not smooth curves fitted to data points, but rather a tracing of straight lines drawn between data points by a computer and plotter. Because there are 6 data points per hour, the straight lines appear as a smooth curve. Each data point represents the average of two samples from the same mortar batch. No two companion samples differed from each other by more than approximately 2° F at any time. All data and references referring to the temperature rise or thermal gradient in concrete presented in Figure 5.1 to 5.12 are single readings.

To calculate the temperature rise, the initial mix temperature was subtracted from all the average temperatures at later times. The initial mix temperature was assumed as the lowest temperature during the first 30 minutes after batching, because for some mixes there was a slight temperature differential on the order of 1° F in the first half hour. All temperature changes prior to the time corresponding to the assumed initial temperature were set to zero.

5.2.2 Peak Temperature. The peak temperature rise for each mortar mix was determined by subtracting the initial mix temperature from the maximum average sample temperature for two companion samples. The temperature rise gradients along the vertical cross sections of the concrete samples were similarly determined except each point represents a single reading not an average of two readings.

5.2.3 Time to Peak Temperature. In addition to monitoring the peak temperature, it is important to know when the peak occurs. To reduce the tendency for thermal cracking in concrete with exposed surfaces, it is best not to allow the peak internal concrete temperature to occur at the same time when the ambient temperature reaches a daily low. Also, from the times to peak observed under nearly adiabatic conditions in this study, one can predict how the temperature rise will be affected under nonadiabatic conditions. If the time to the peak temperature is great under nearly adiabatic conditions, then under conditions where the rate of heat loss is significant a lower temperature rise may develop. That is because as the time to peak increases, there is more time for heat to dissipate.

In this study, the time to the peak temperature corresponds to a point on the temperature curve where the curve begins to plateau and not the time when the actual maximum temperature is reached. Expressing the time to the peak temperature as the earlier time provides a more reliable determination of the time to the peak and a better comparison between the higher temperature curves which are generally rounded at the peak and the lower temperature curves which tend to be very flat at the peak. The flatter, lower temperature curves have a negligible change in temperature for a few hours before and after the maximum temperature is reached. Thus, the time elapsed to the peak temperature was taken as the time to reach 95 percent of the actual maximum temperature rise. By inspection the arbitrary choice of 95 percent appears to be reasonable.

The temperature gradient profiles correspond to the time of the actual peak temperature because that is when the gradient was most severe.

5.3 Thermal Gradients

The peak temperature rise in the center of each test sample is shown in Table 5.1.

In this report, temperature differential is the mid-depth temperature minus the exterior surface temperature (T_o in Chapter 3). The concrete surface temperature (depth = 0 in.) was monitored by placing a thermocouple against the concrete surface but exposed. Table 5.1 shows the maximum temperature differential in each sample. The maximum temperature differential generally occurred when the maximum internal temperature occurred.

The temperature profiles and thermal gradients for Tests 1, 2, 3, and 4 are shown in Figures 5.1 to 5.10.

Table 5.1 Results of thermal gradient tests.

Test	Initial Concrete Temperature (F)	Temperature Rise (F)	Temperature Differential (F)
Test 1	84	71	28
Test 2	84	71	37
Test 3(exposed surface)	87	47	43
Test 3(covered surface)	87	51	14
Test 4(exposed surface)	83	38	50
Test 4(covered surface)	83	48	37

5.4 Temperature Rise in Mortar

5.4.1 Test Parameters. Before conducting tests to determine the effect of fly ash on the temperature rise in mortar, the effect of a few important test parameters were investigated. Such parameters tested were the insulating environment around the mortar sample, ambient temperature, initial mix temperature, cement type and content, and water to cementitious materials ratio. A thorough review of those parameters was not the purpose of this study but a brief study was necessary to show which parameters have an effect and how sensitive the results of this study are to a change in one of those test parameters. Regardless of the effect of the test parameters, an attempt was made to keep all five of the above mentioned test parameters constant.

5.4.1.1 Correlation of Small Samples to Mass Concrete. Two experiments were run to correlate the temperature rise in a 14.6 pound (0.098 cubic feet which is half the volume of a standard cylinder) insulated sample to that in a 4 ft cube (the same cubes used in temperature gradient Test 1 and Test 2). The same ready mixed concrete was used for the small sample and mass concrete, and the coarse aggregate was left in the small sample. The mass concrete and insulated sample were exposed to the same room conditions. The small samples were found to have a lower peak temperature than the mass concrete by 27° F for Test 1 and 28° F for Test 2 as shown in Figures 5.11 and 5.12.

CONCRETE TEMPERATURE : TEST 1
4' CONCRETE CUBE, 84°F INITIAL TEMPERATURE

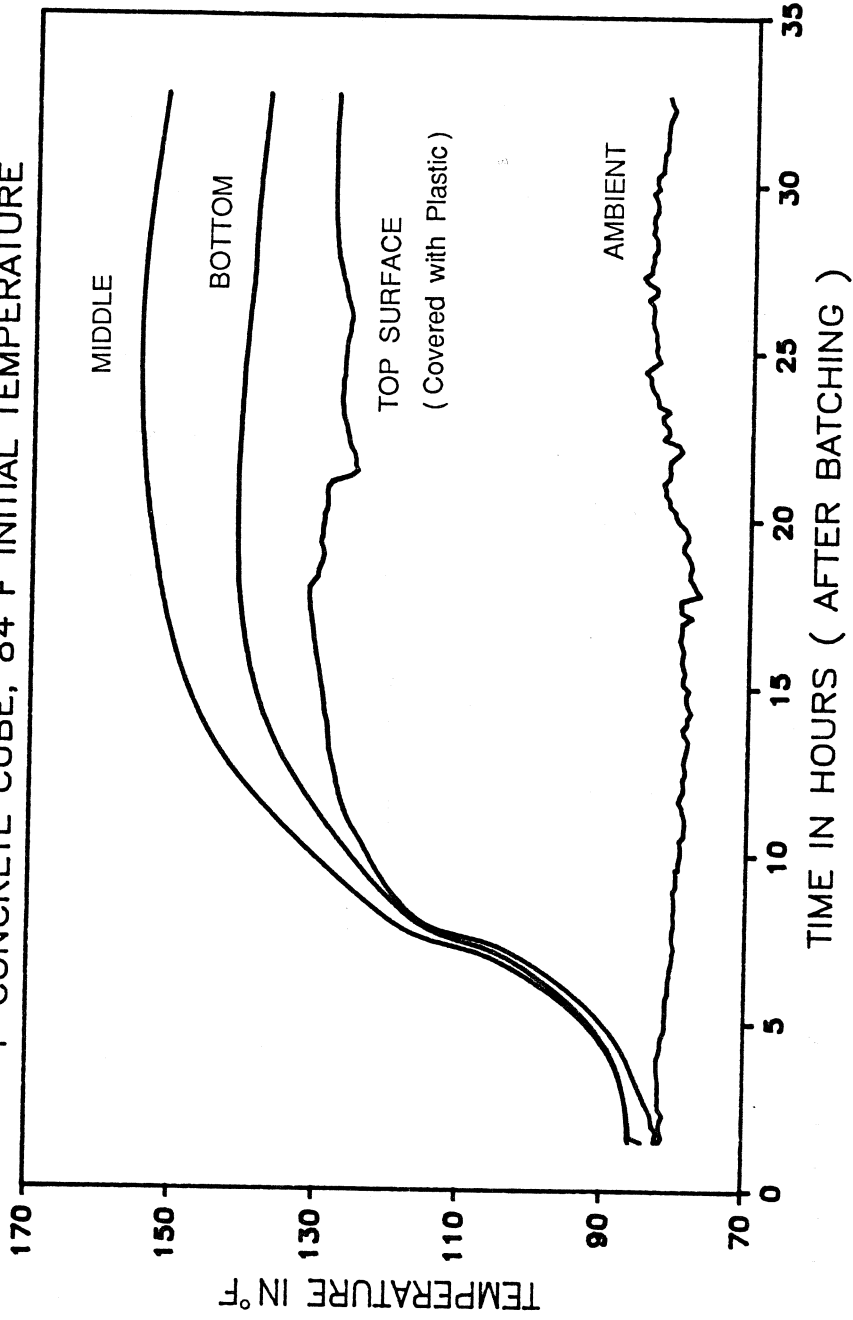

Figure 5.1 Temperature profile for Test 1.

VERTICAL TEMPERATURE GRADIENT

4' CUBE, AT PEAK TEMP. (23.5 HOURS AFTER BATCHING)

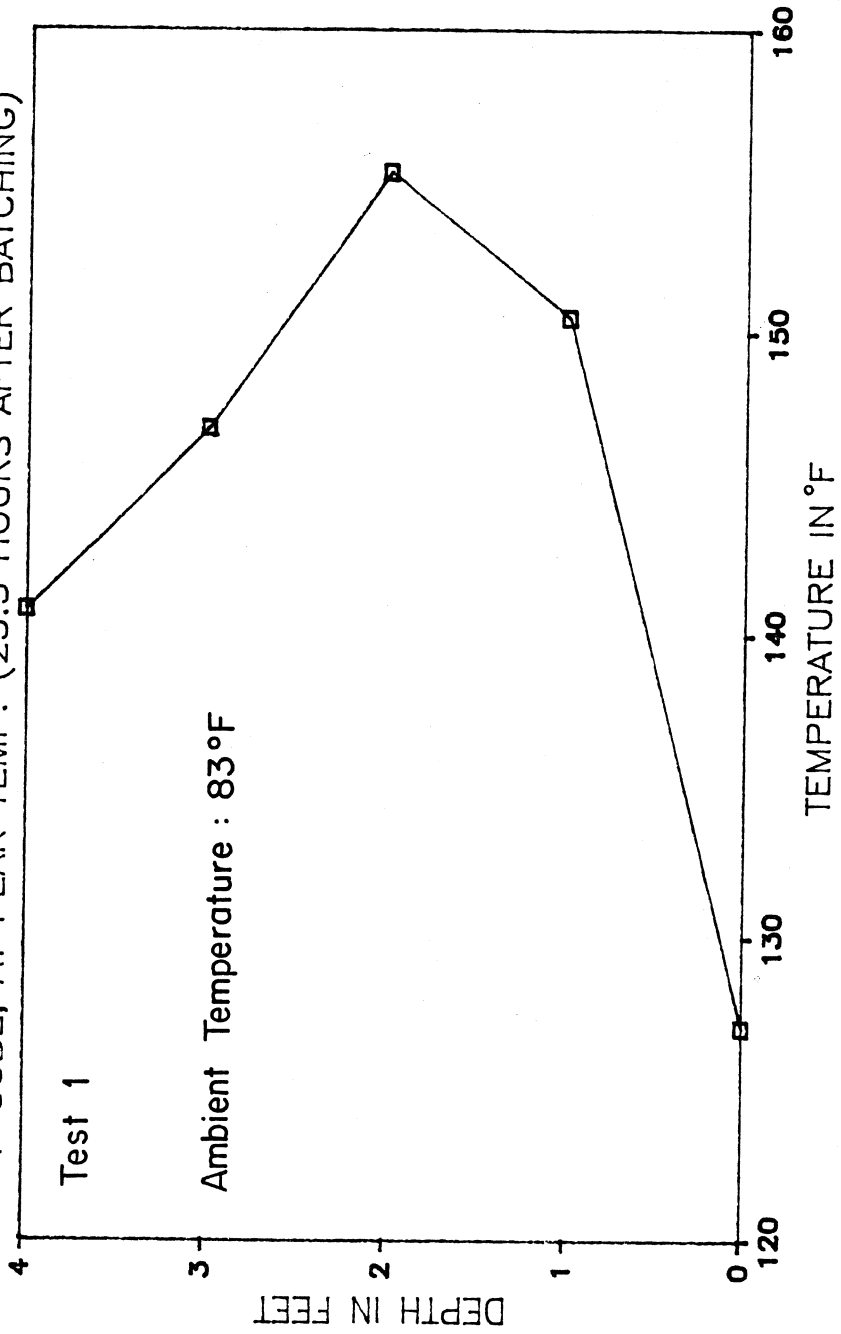

Figure 5.2 Maximum vertical temperature gradient for Test 1.

CONCRETE TEMPERATURE : TEST 2
4' CONCRETE CUBE, 84°F INITIAL TEMPERATURE

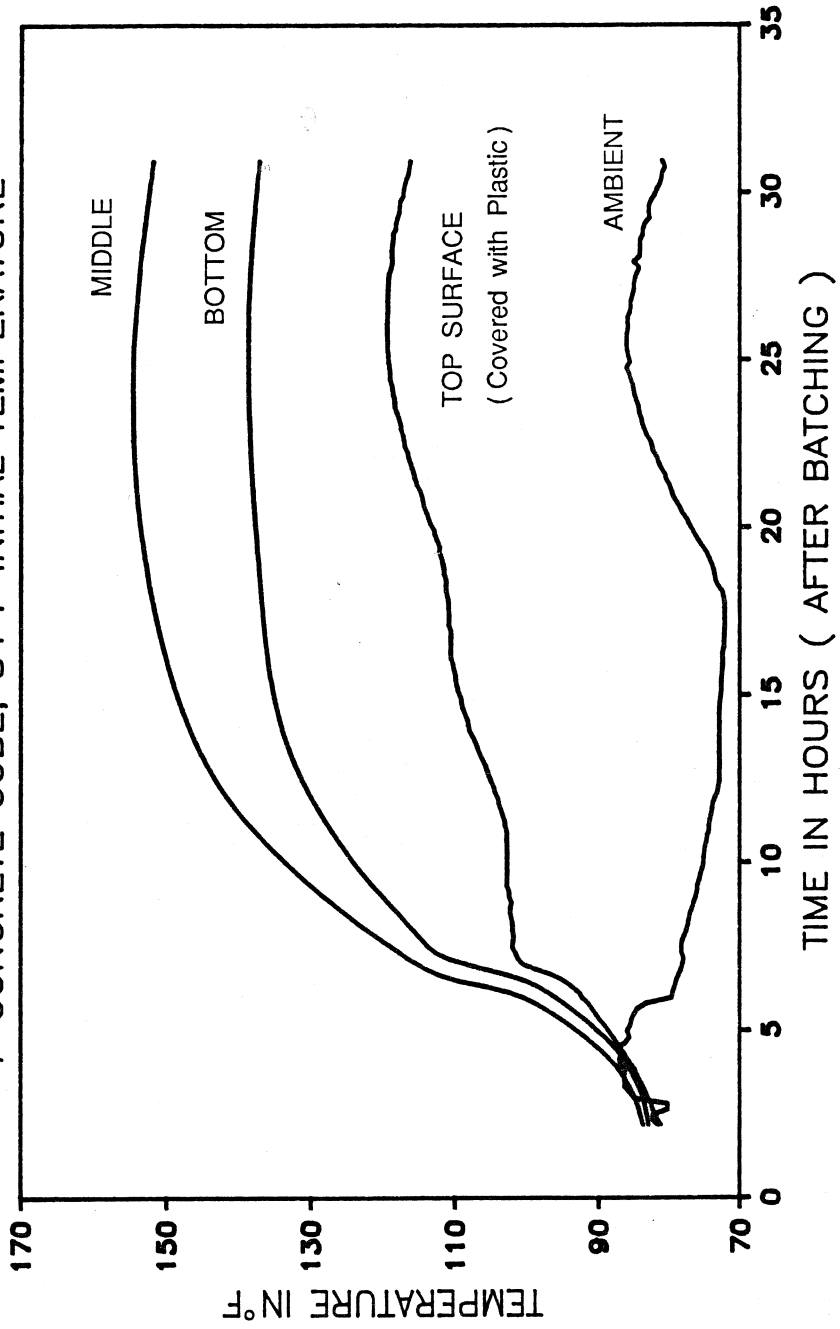

Figure 5.3 Temperature profile for Test 2.

VERTICAL TEMPERATURE GRADIENT
4' CUBE, AT PEAK TEMP. (23.5 HOURS AFTER BATCHING)

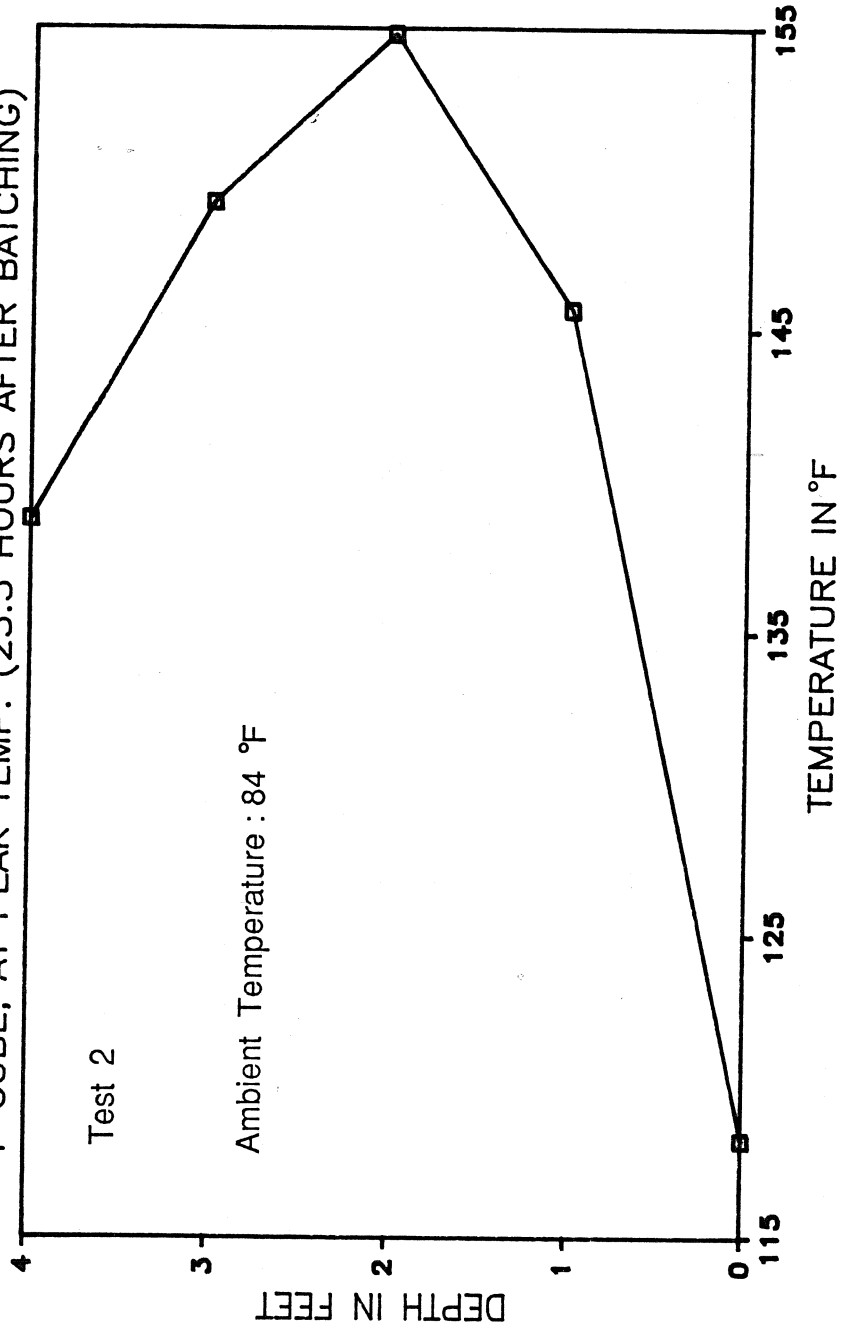

Figure 5.4 Maximum vertical temperature gradient for Test 2.

CONCRETE TEMPERATURE : TEST 3
EXPOSED SURFACE, 6" TOTAL BEAM DEPTH

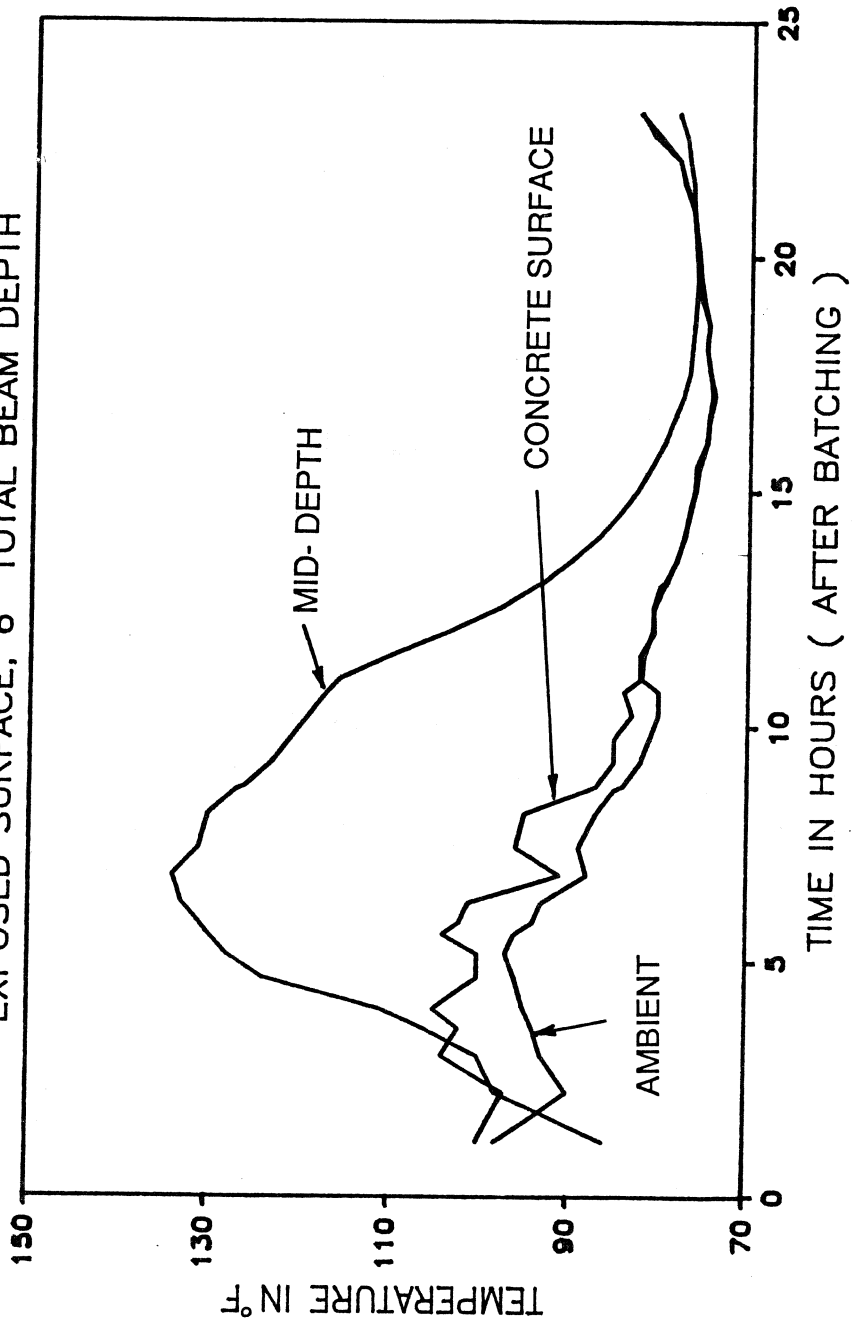

Figure 5.5 Temperature profile for Test 3 sample with top surface exposed.

CONCRETE TEMPERATURE : TEST 3
COVERED SURFACE, 6" TOTAL BEAM DEPTH

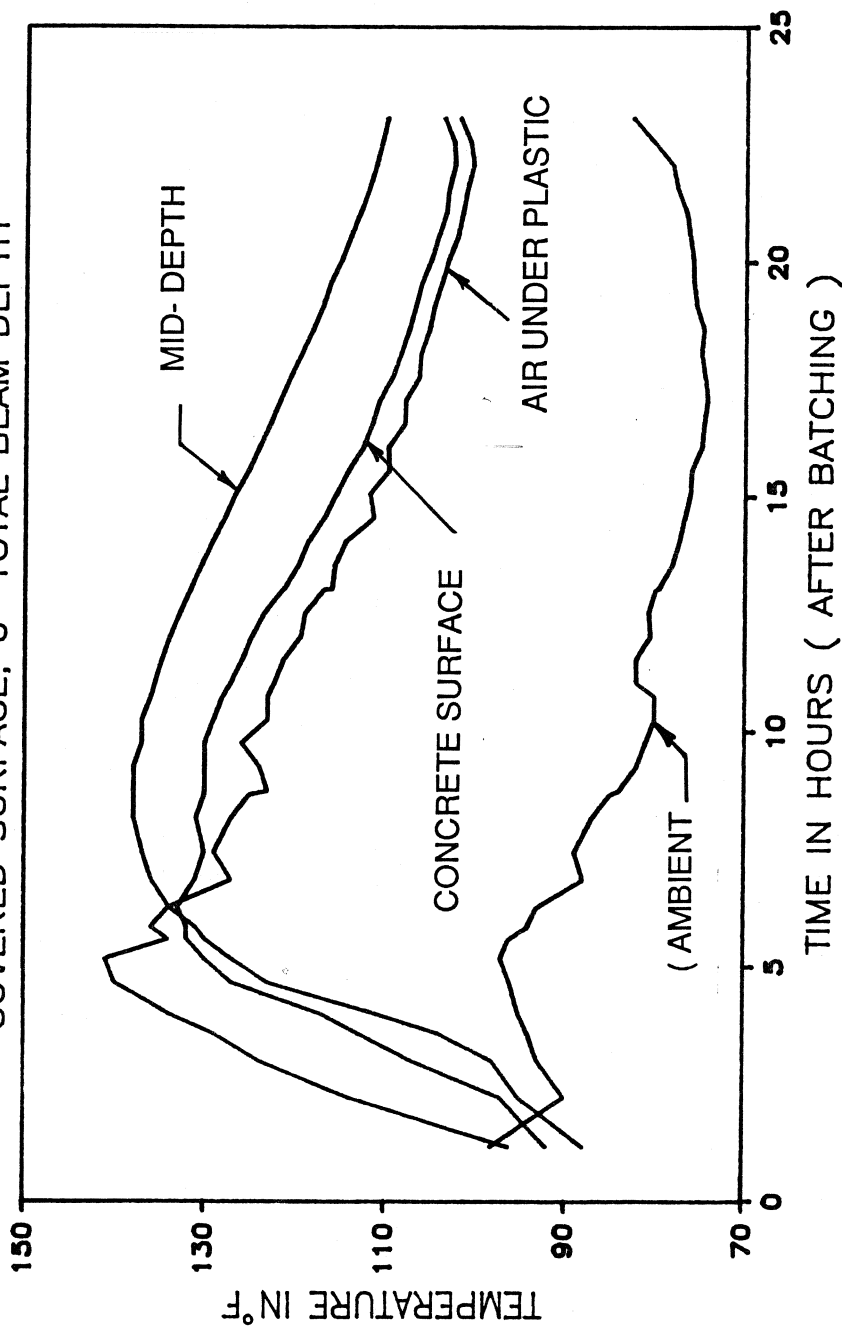

Figure 5.6 Temperature profile for Test 3 sample with top surface covered with damp burlap and plastic.

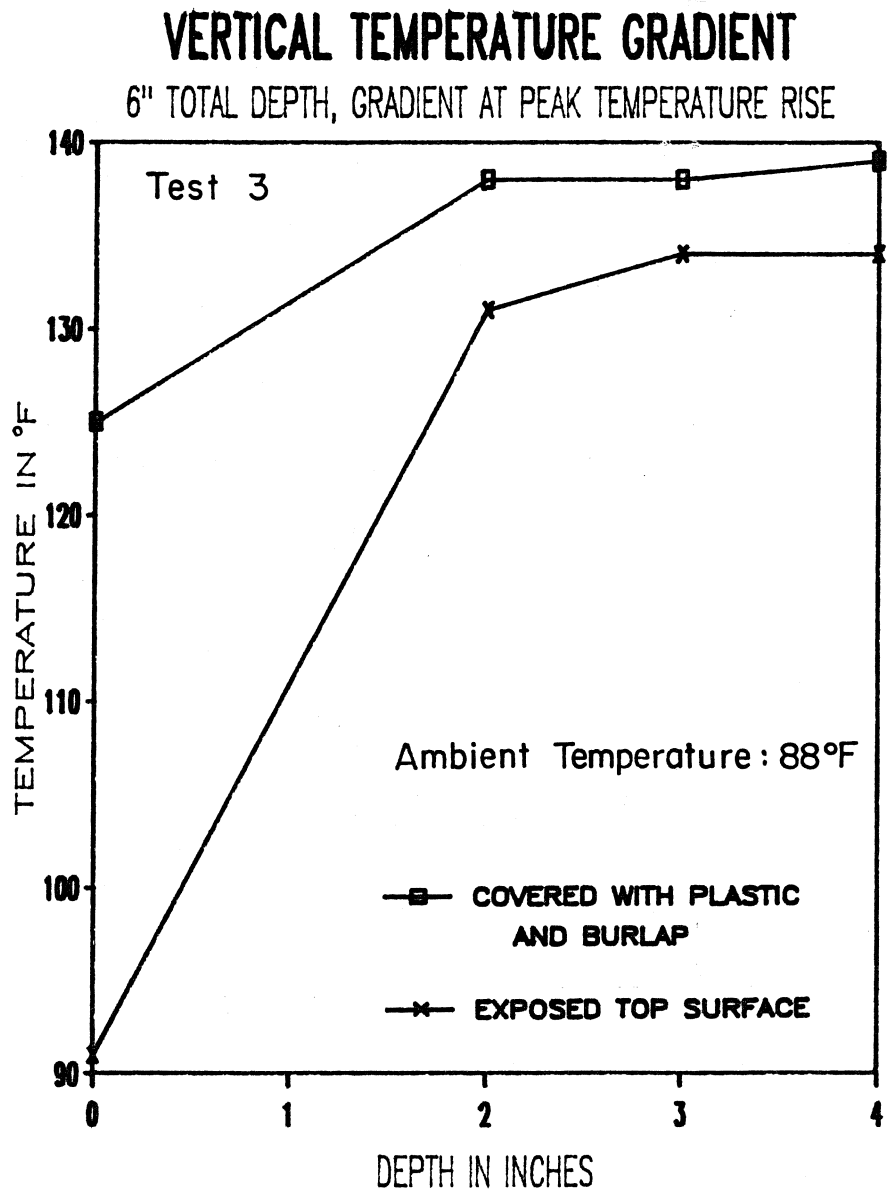

Figure 5.7 Maximum vertical temperature gradients for Test 3 samples.

CONCRETE TEMPERATURE : TEST 4
EXPOSED SURFACE, 18" TOTAL DEPTH

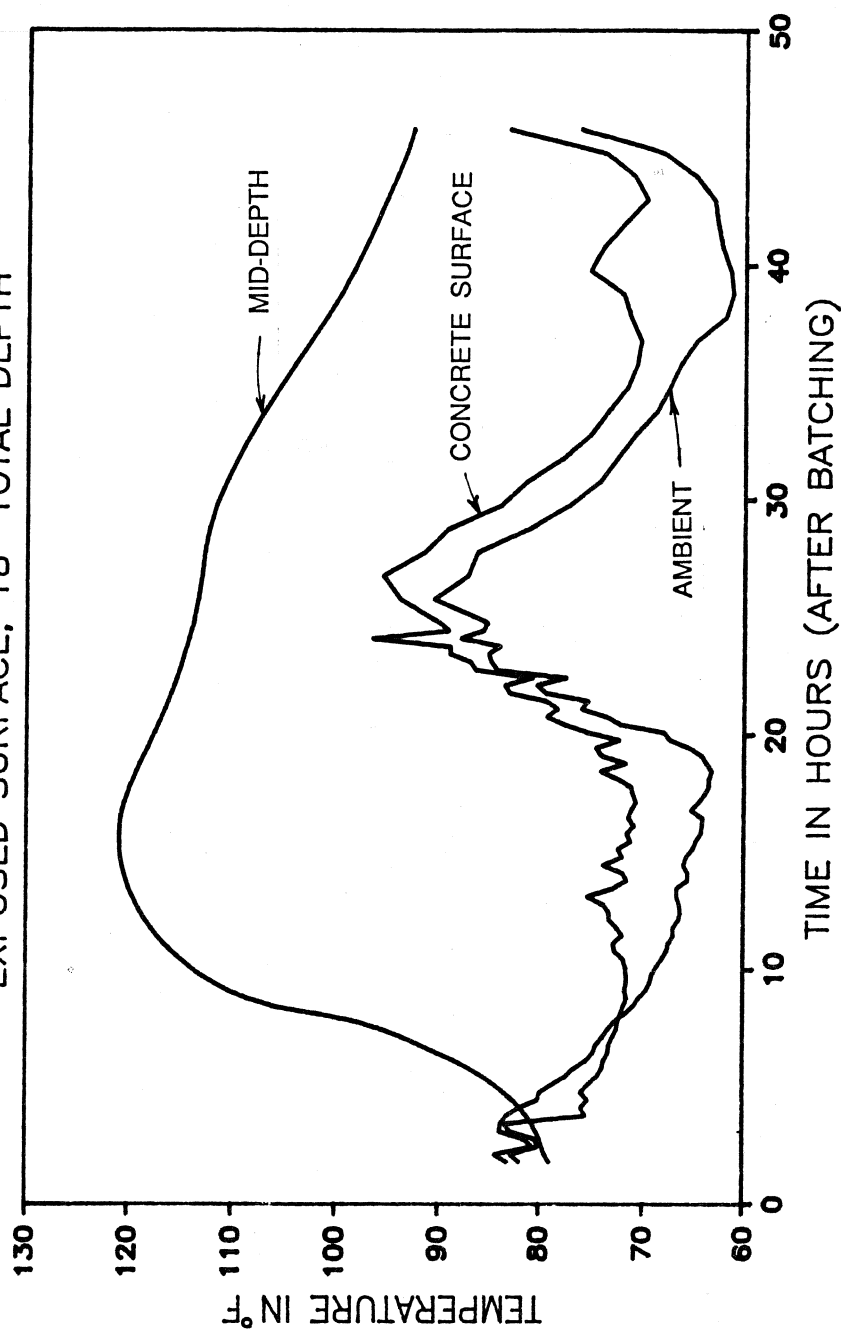

Figure 5.8 Temperature profile for Test 4 sample with top surface exposed.

CONCRETE TEMPERATURE : TEST 4

COVERED SURFACE, 18" TOTAL DEPTH

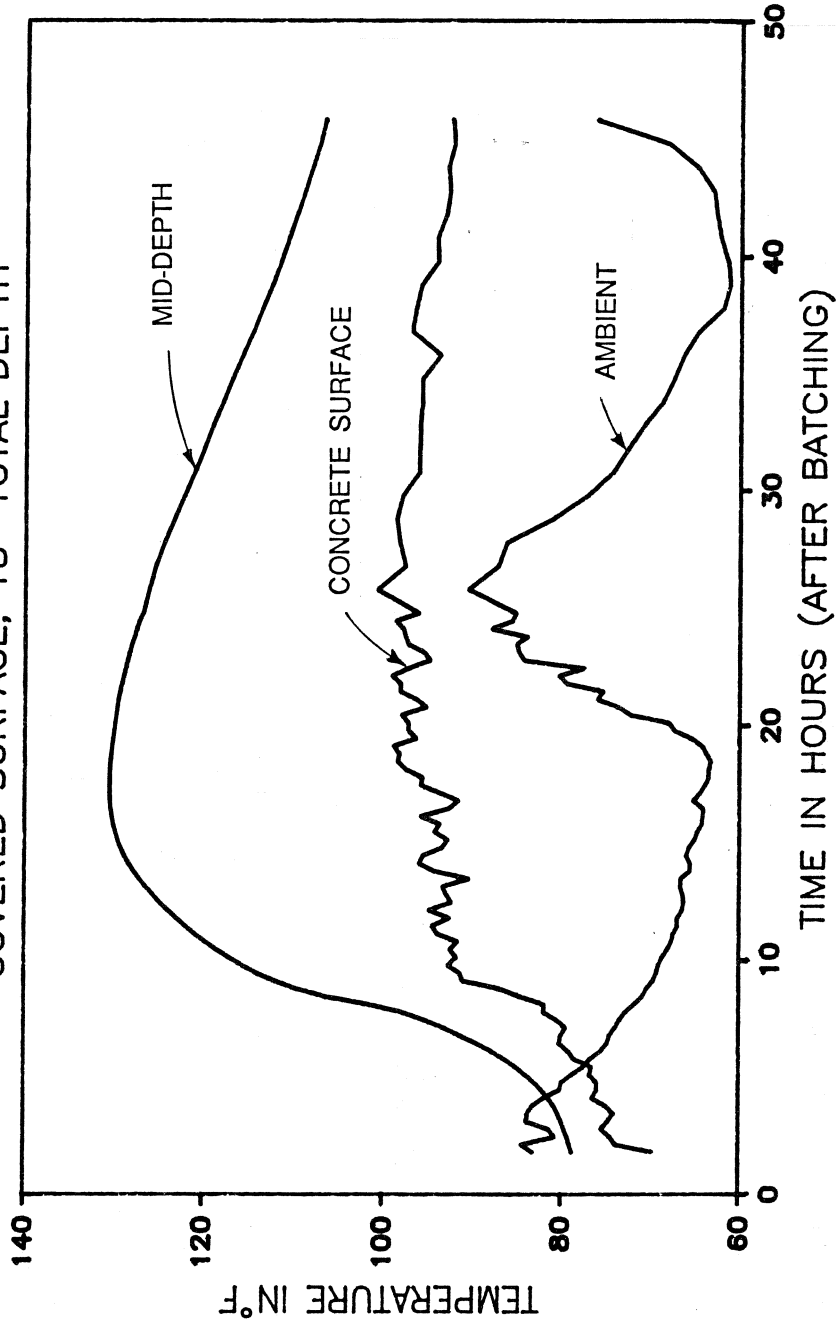

Figure 5.9 Temperature profile for Test 4 sample with top surface covered with damp burlap and plastic.

VERTICAL TEMPERATURE GRADIENT AT PEAK TEMPERATURE ON 18" DEPTH

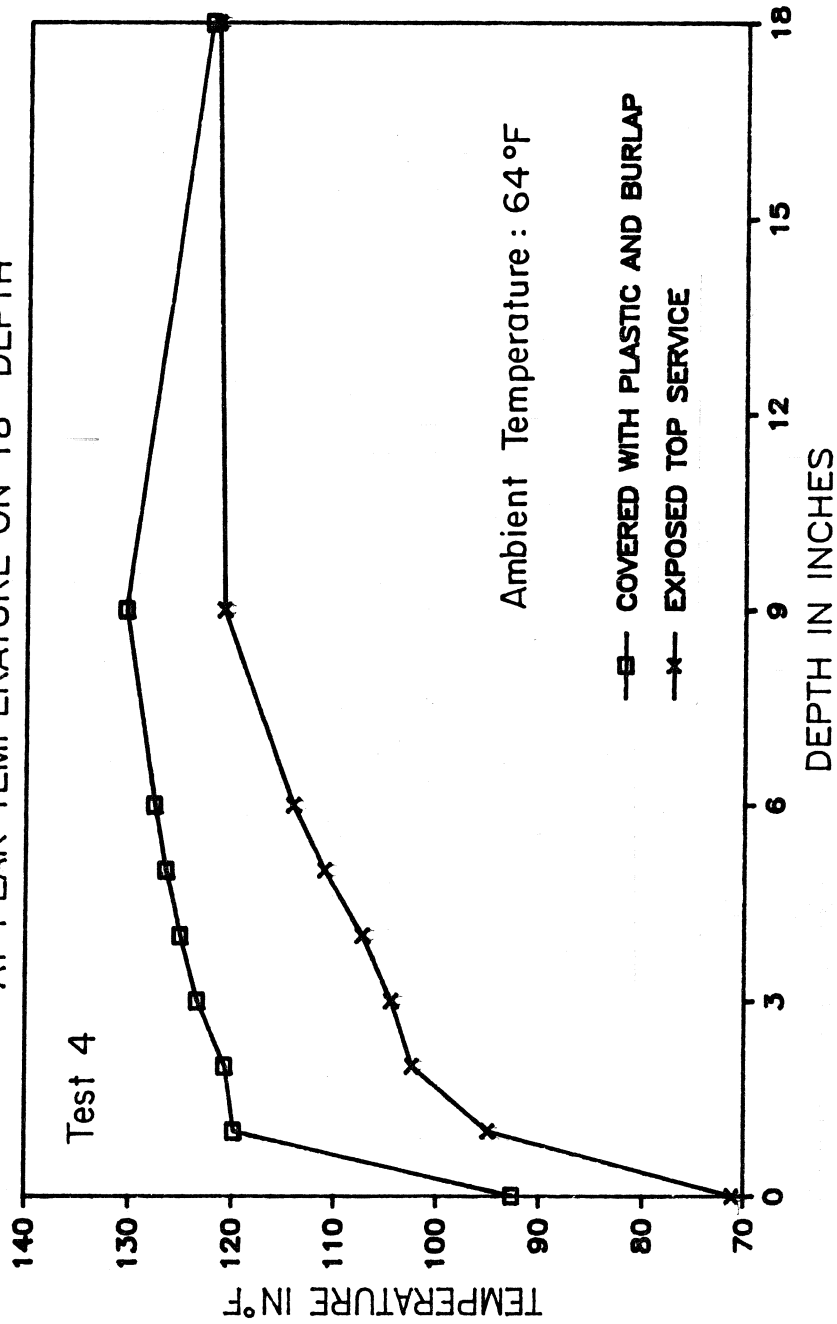

Figure 5.10 Maximum vertical temperature gradients for Test 4 samples.

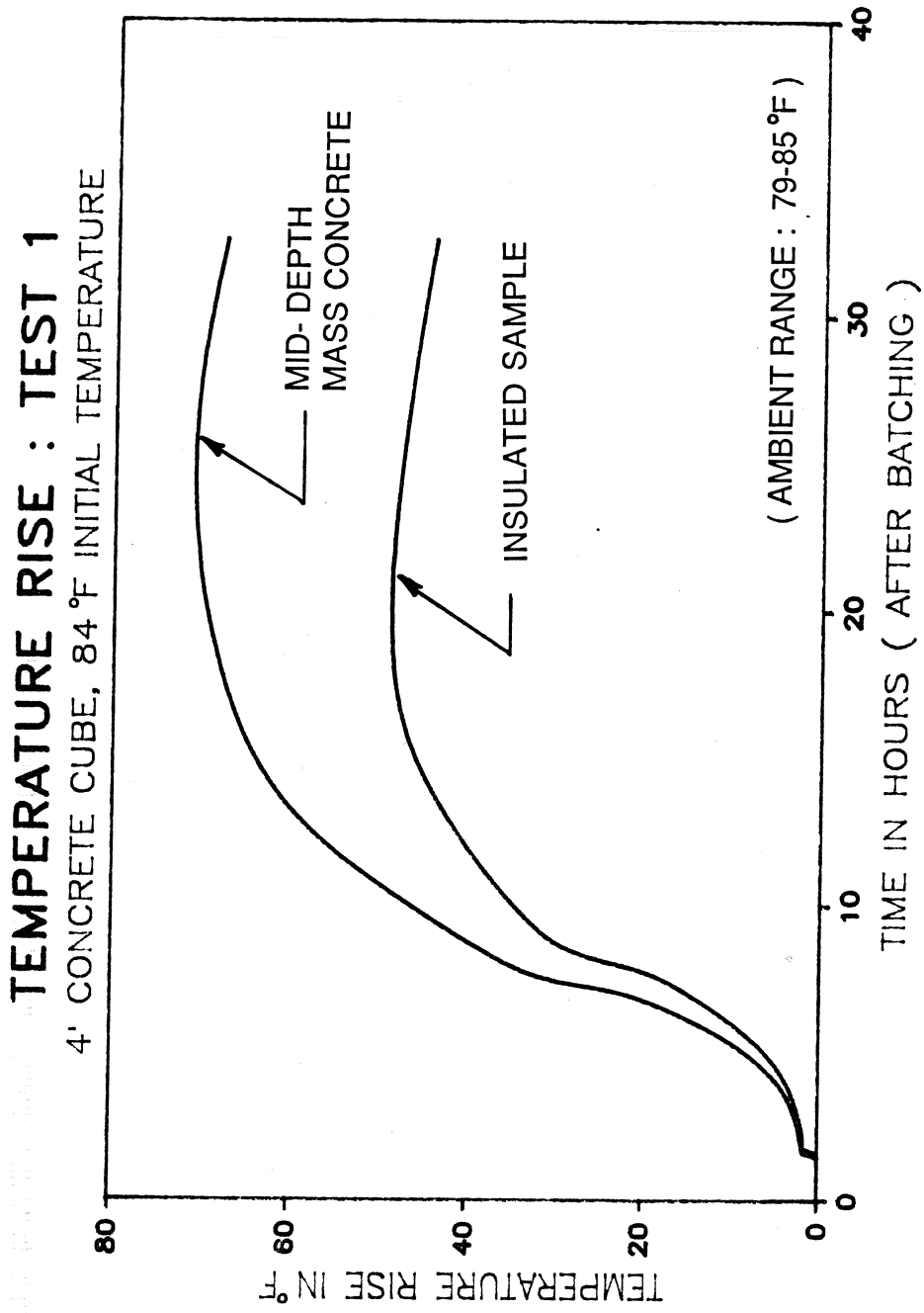

Figure 5.11 Comparison of temperature rise in Test 1 sample to insulated sample.

TEMPERATURE RISE : TEST 2

4' CONCRETE CUBE, 84 F INITIAL TEMPERATURE

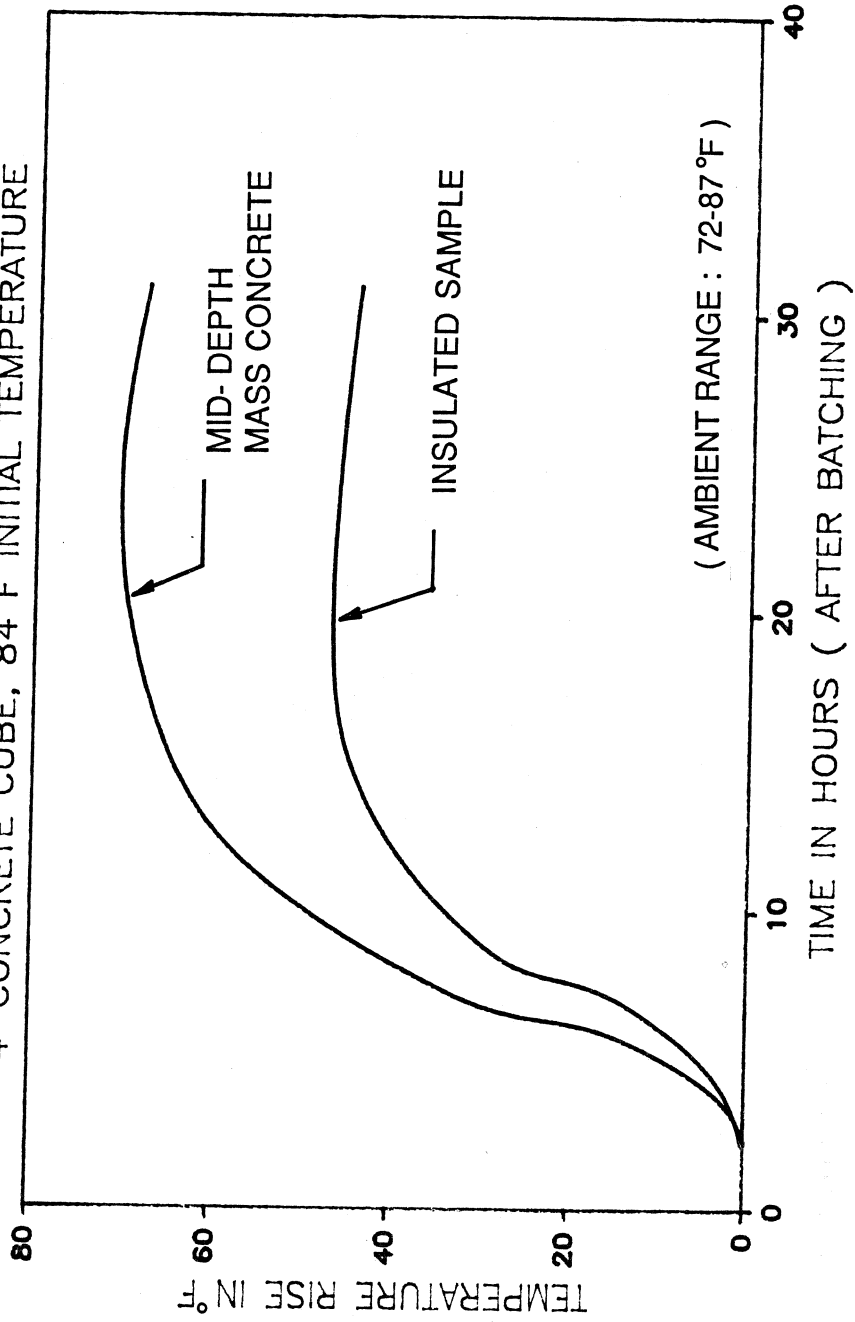

Figure 5.12 Comparison of temperature rise in Test 2 sample to insulated sample.

5.4.1.2 Ambient Temperature. The ambient temperature of the surroundings near the insulated boxes containing the mortar mixes was varied from a range of 68 - 73°F to a range of 79 - 84°F. The mortar mixes in this experiment contained Type I-II cement. The lower ambient temperature range produced a peak temperature rise of 48.7°F and a time to 95 percent of the peak temperature of 10.8 hours compared to 51.9°F and 12.0 hours for the higher ambient temperature range as shown in Figure 5.13. This difference could be attributed to the different heat loss experienced under each ambient condition.

5.4.1.3 Initial Mix Temperature. For Type I-II cement without fly ash and initial mix temperatures of 79°F, 87°F and 94°F the peak mortar temperature rises were 76°F, 75.3°F, and 78.3°F respectively. The times to 95 percent of the peak temperature rise for the low, middle, and high initial mix temperatures were 11.5, 10, and 8.3 hours respectively.

Mortar with Type I-II cement and 35 percent FA A (Type A) by volume with initial mix temperatures of 79°F and 92°F produced peak temperature rises of 51.9°F and 49.5°F respectively. As the initial temperature rose from 79°F to 92°F the time to 95 percent of the peak temperature decreased from 12 hours to 9.5 hours.

Mortar with Type I-II cement and 35 percent FA C (Type B) by volume with initial mix temperatures of 80°F and 92°F produced peak temperature rises of 77.0°F and 72.6°F respectively. As the initial temperature rose from 80°F to 92°F the time to 95 percent of the peak temperature decreased from 14 hours to 11.5 hours.

The results from the tests with varying initial mix temperatures are shown in Figures 5.14 and 5.15.

5.4.1.4 Cement Type and Content. Figure 5.16 provides a comparison of the temperature profiles for each of the three cement types without mineral or chemical admixtures. The Type III cement mortar produced the highest temperature, followed in order of decreasing peak temperature by Type I cement mortar, and Type I-II cement mortar. The peak temperatures and times to 95 percent of the peak for the Type III, Type I, and Type I-II cement mortars were 80.8, 71.4, and 63.1°F, and 7.7, 9.7, and 11.5 hours respectively.

The effect of the cement content on the temperature rise in mortar was studied by monitoring mixes containing no fly ash and 10.7, 16.8, and 23.6 percent of Type I cement per unit volume of mortar. Those three mixes had sand to cement ratios by

VARIABLE AMBIENT TEMPERATURE
 35% TYPE A FLY ASH (FA A) BY VOLUME, TYPE I-II CEMENT

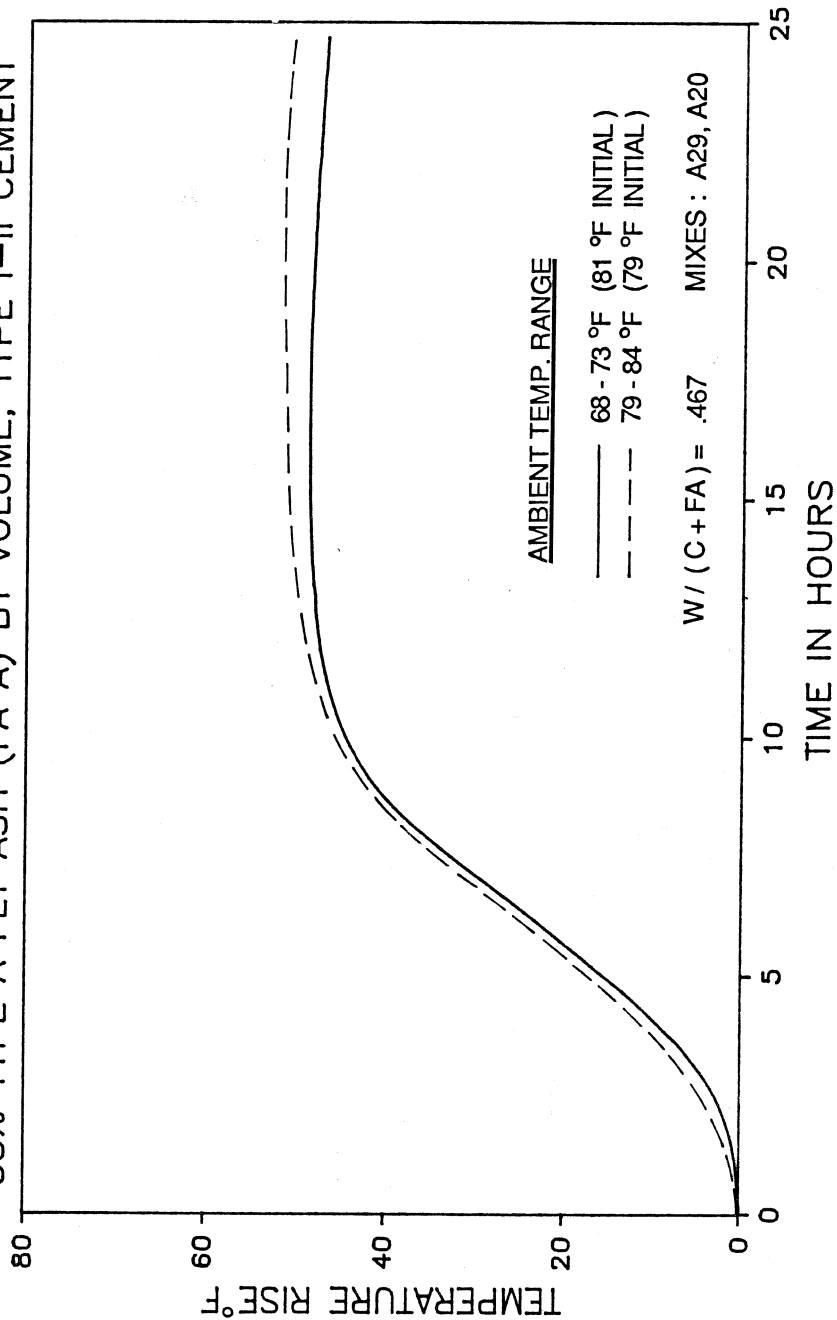

Figure 5.13 Effect of ambient temperature on the temperature rise in mortar containing Type A fly ash.

VARIABLE INITIAL MIX TEMPERATURE .485 W/C RATIO, TYPE I-II CEMENT

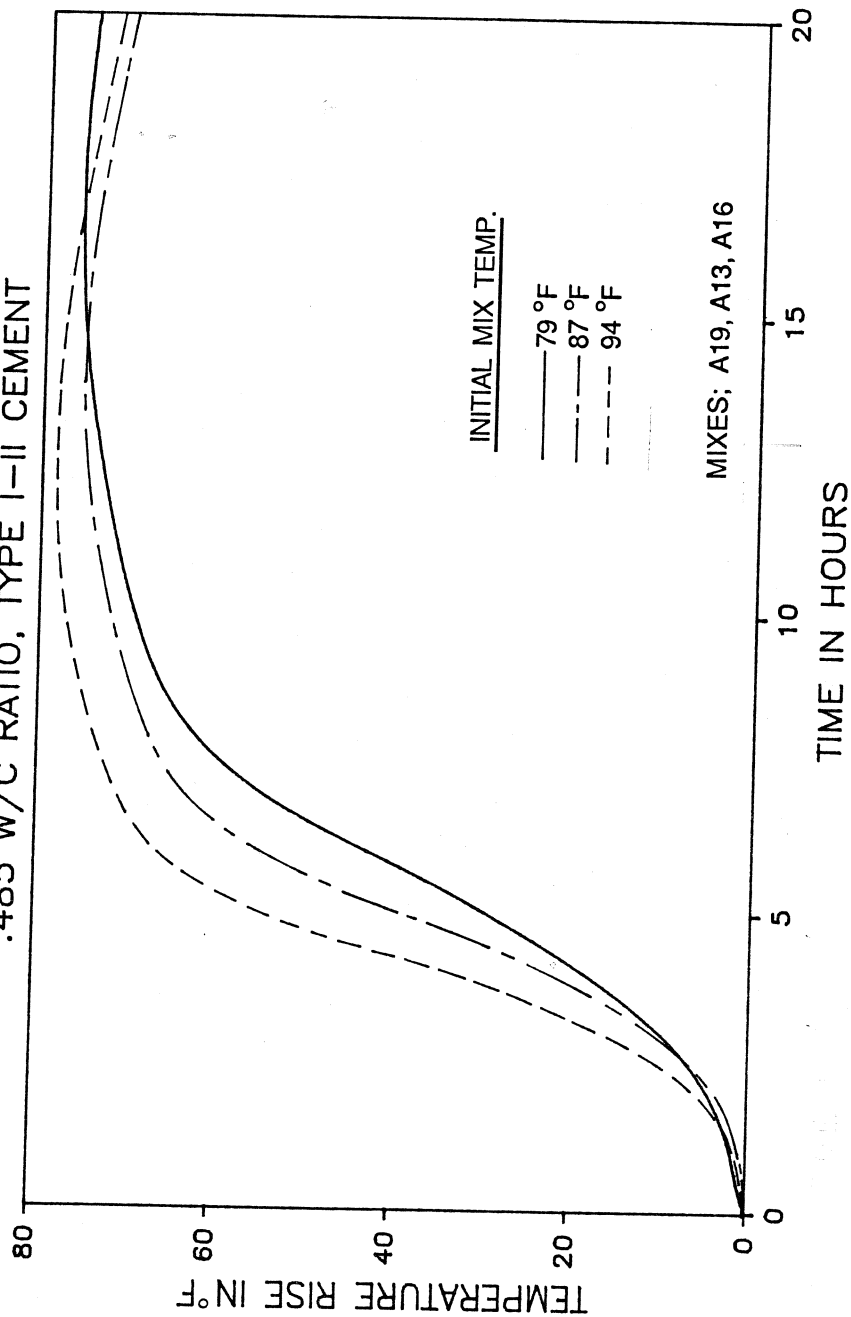

Figure 5.14 Effect of initial mix temperature on the temperature rise in mortar.

VARIABLE INITIAL MIX TEMPERATURE

.485 W/(C+FA) RATIO, TYPE I-II CEMENT

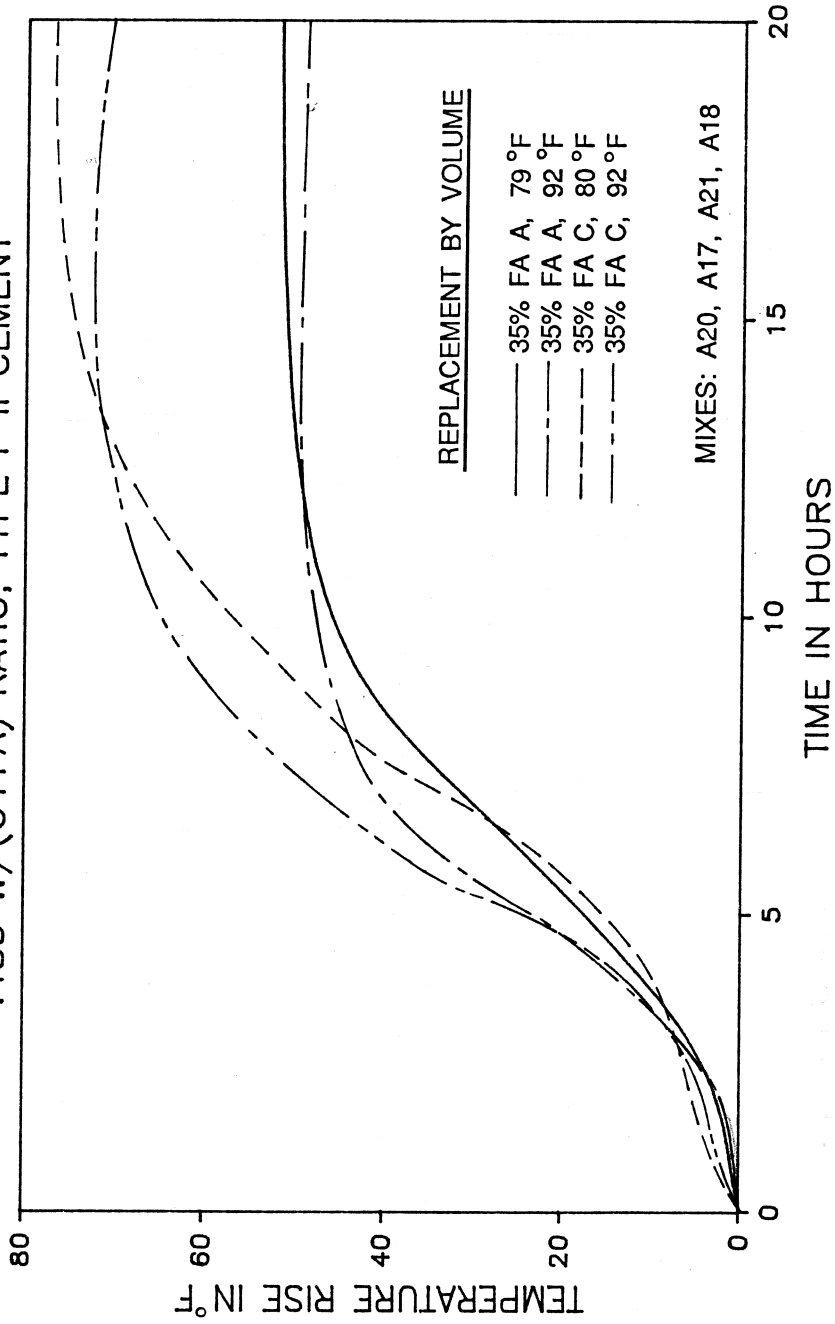

Figure 5.15 Effect of initial mix temperature on the temperature rise in mortar containing fly ash.

VARIABLE CEMENT TYPE
.467 W/(C+FA) RATIO, 0% FLY ASH

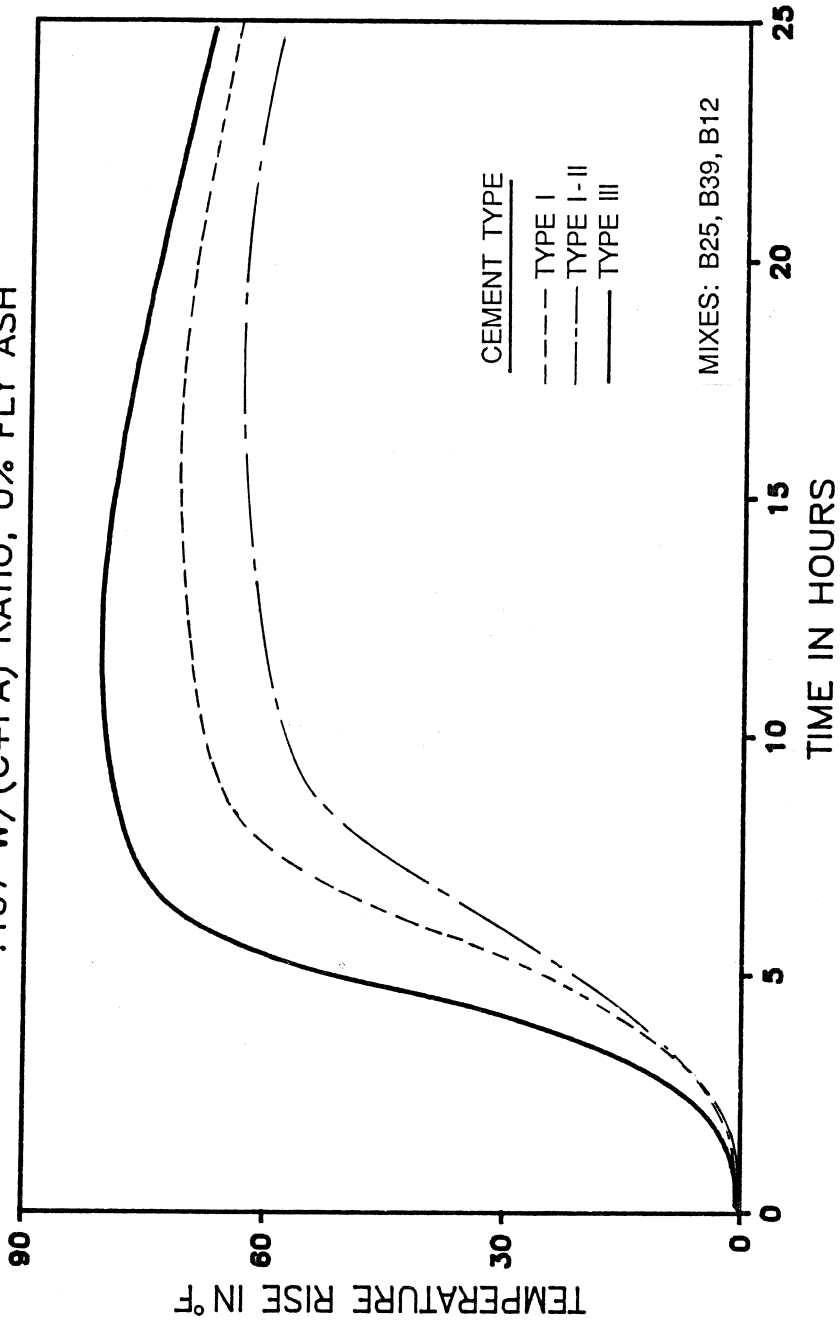

Figure 5.16 Effect of cement type on the temperature rise in mortar.

weight of 5.5, 2.75, and 1.375 respectively. Thus, Figure 5.17 refers to the mixes as half cement content, control, and double cement content. The peak temperature rises for the half cement content, control, and double cement content mixes were 44.0°F, 71.4°F, and 108°F respectively. The times to 95 percent of the peak temperature for increasing cement content were 9.2, 9.7, and 9.2 hours.

5.4.1.5 Water to Cementitious Materials Ratio. Four tests were conducted to determine the effect of the $W/(C+FA)$ ratio by weight on the temperature rise in mortar. The effect of the $W/(C + FA)$ ratio was monitored for mixes differing only in water content. The effect of the $W/(C+FA)$ ratio was monitored for mixes with each of three cement types, three different fly ashes, and three replacement rates. The results of the effect of varying the water to cementitious material ratio are shown in Figures 5.18 to 5.21.

Figure 5.18 shows that as the $W/(C+FA)$ ratio is raised from 0.467 to 0.485 for a mix containing Type III cement and 20 percent FA B (Type A), the peak temperature rise decreases from 66.5 to 65.3°F, and the time to 95 percent of the peak temperature decreases from 13.3 hours to 8.5 hours.

Figure 5.19 shows that as the $W/(C+FA)$ ratio is raised from 0.467 to 0.545 for a mix containing Type I cement and 35 percent FA D (Type B) the temperature rise is unchanged at 64.0°F and the time to peak decreases slightly from 15.8 hours to 15.7 hours.

Figure 5.20 shows that as the W/C ratio is increased from 0.467 to 0.55 for a mix containing Type I-II cement and no fly ash, the temperature rise increases from 63.1 to 70.0°F and the time to peak decreases from 17.7 hours to 11.5 hours.

Finally, Figure 5.21 shows that as the $W/(C+FA)$ ratio is increased from 0.385 to 0.55 for a mix containing Type I-II cement and 35 percent FA A (Type A), the temperature rise decreases from 40.8 to 39.6°F and the time to peak increases from 11.0 hours to 13.0 hours.

5.4.2 Temperature Rise Profiles. The effect of the partial replacement of cement with fly ash on the temperature rise in concrete was studied by monitoring the temperature rise in mortar samples. The results of the tests conducted to measure the temperature rise in mortar samples are shown in Figures 5.22 to 5.36. In those tests, the cement type, fly ash type, and the percent replacement were varied. The water to

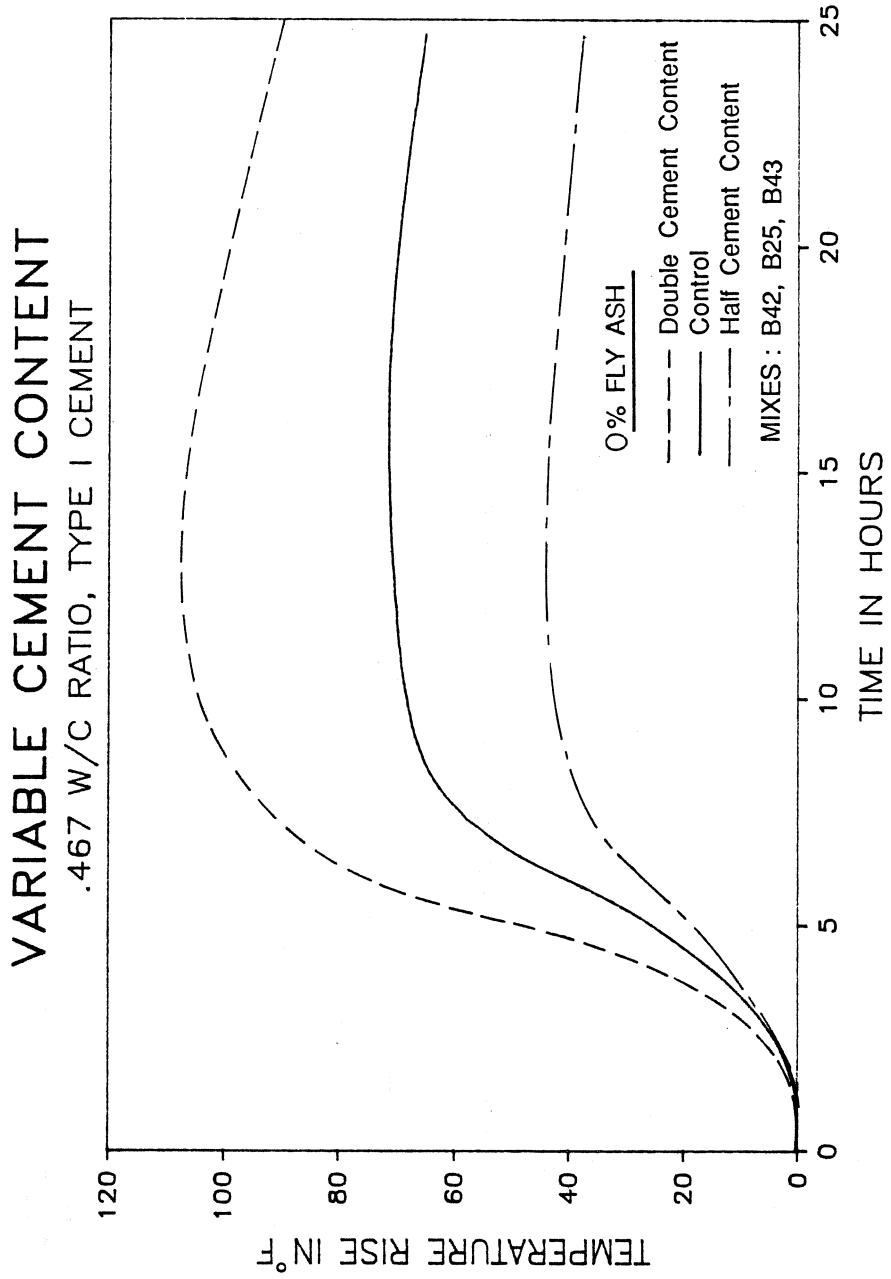

Figure 5.17 Effect of cement content on the temperature in mortar.

VARIABLE $W/(C+FA)$ RATIO
 20% TYPE A FLY ASH (FA B) BY VOLUME, TYPE III CEMENT

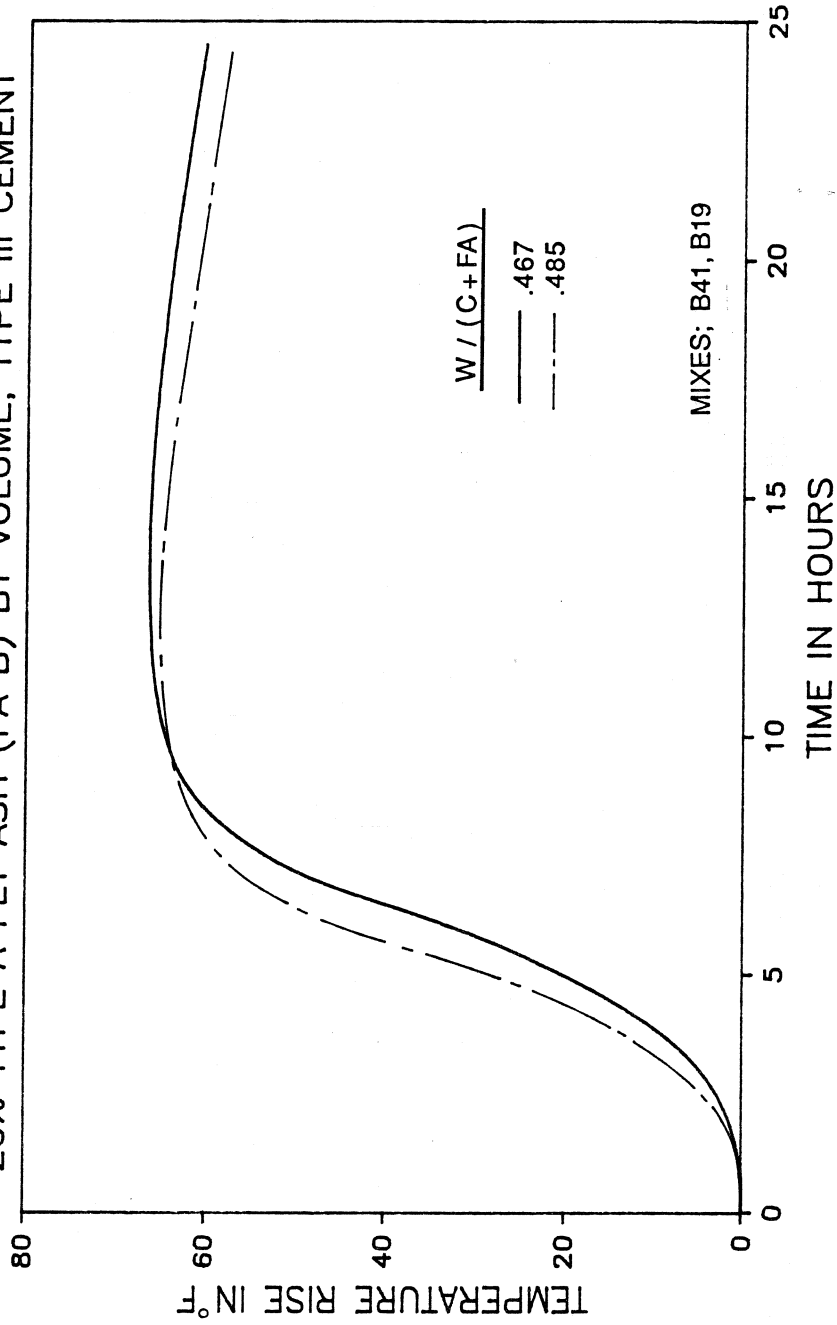

Figure 5.18 Effect of the water to cementitious materials ratio on the temperature rise in mortar containing fly ash.

VARIABLE $W/(C+FA)$ RATIO
35% TYPE B FLY ASH (FA D) BY VOLUME, TYPE I CEMENT

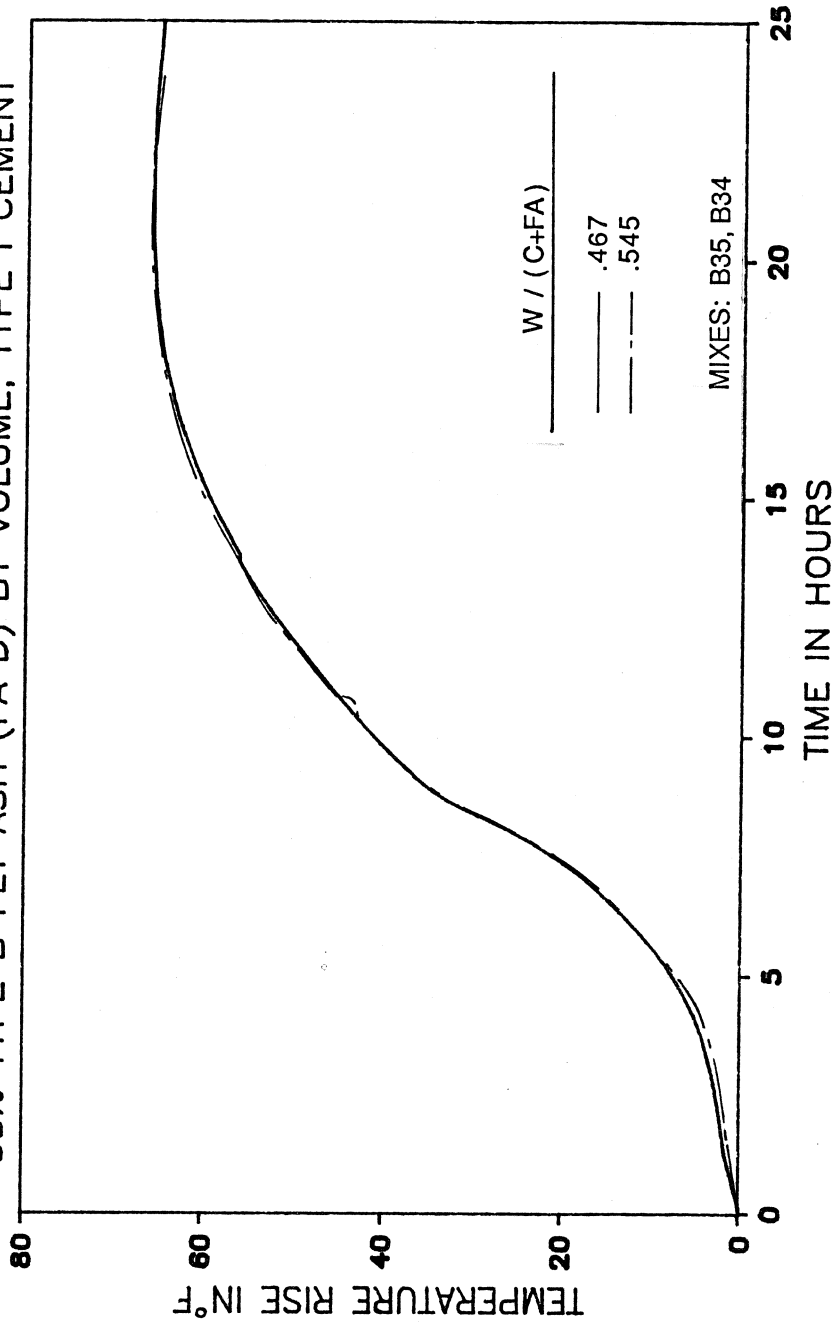

Figure 5.19 Effect of the water to cementitious materials ratio on the temperature rise in mortar containing fly ash.

VARIABLE W/C RATIO
TYPE I-II CEMENT

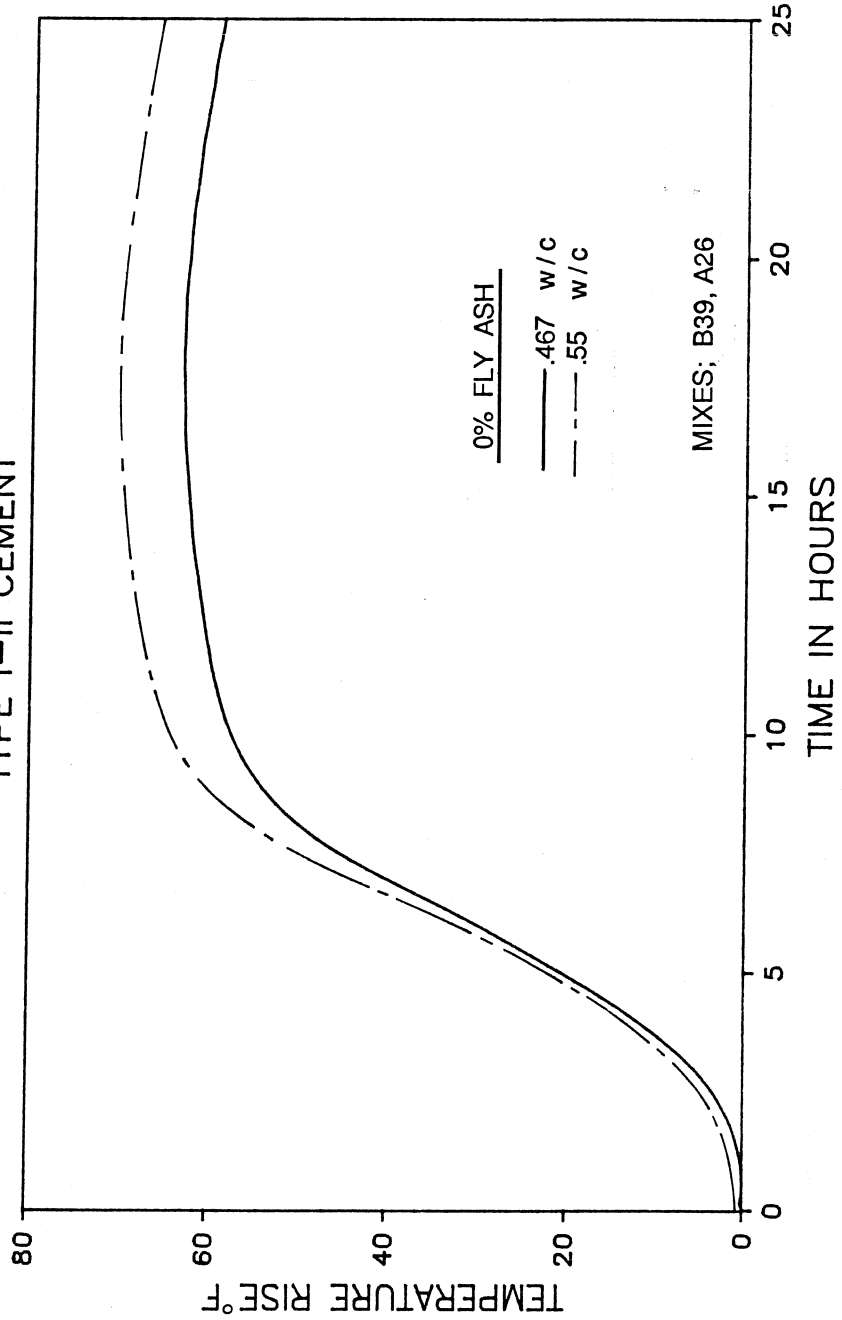

Figure 5.20 Effect of the water to cement ratio on the temperature rise in mortar.

VARIABLE $W/(C+FA)$ RATIO
35% TYPE A FLY ASH (FA A) BY VOLUME, TYPE I-II CEMENT

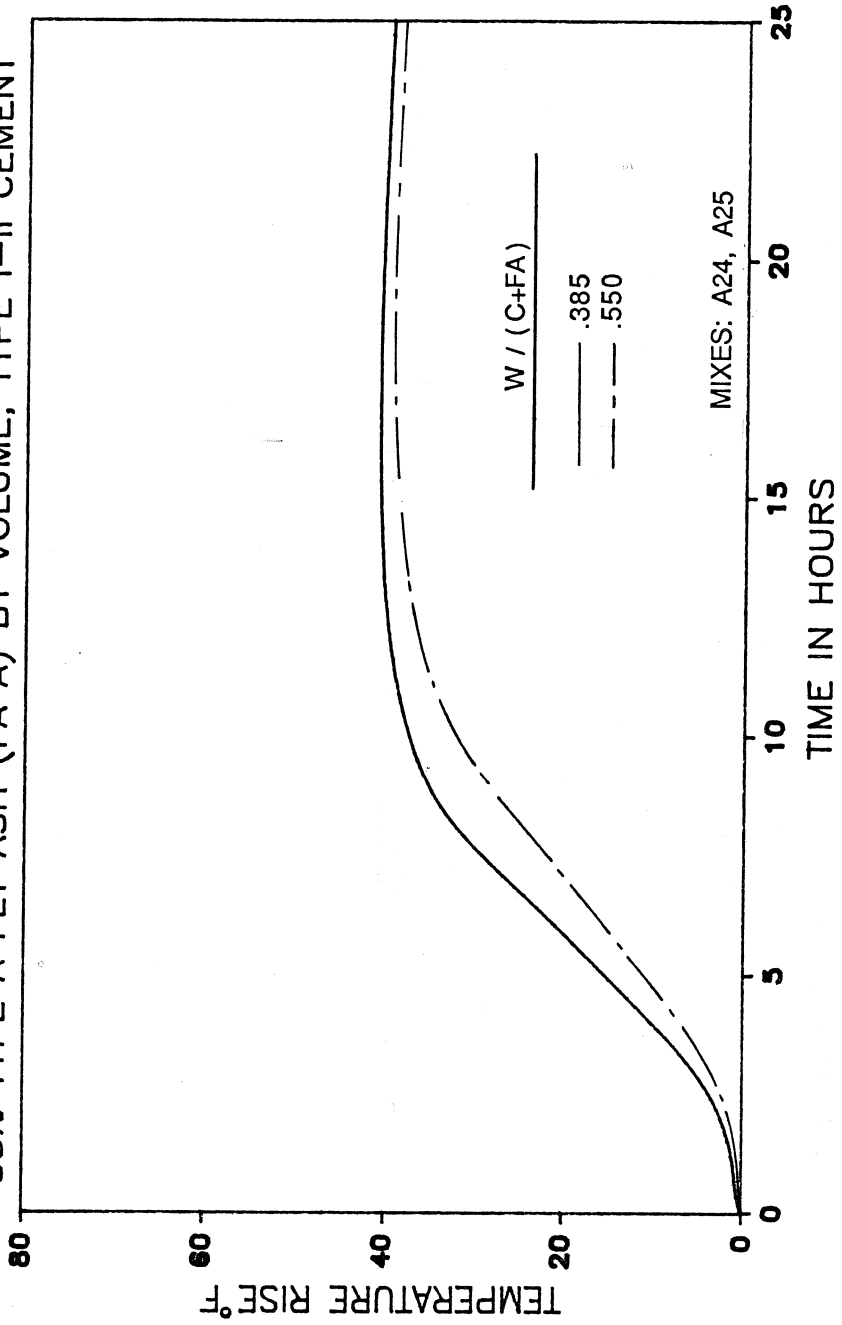

Figure 5.21 Effect of the water to cementitious materials ratio on the temperature rise in mortar containing fly ash.

TYPE A FLY ASH
.467 W/(C+FA) RATIO, TYPE I-II CEMENT

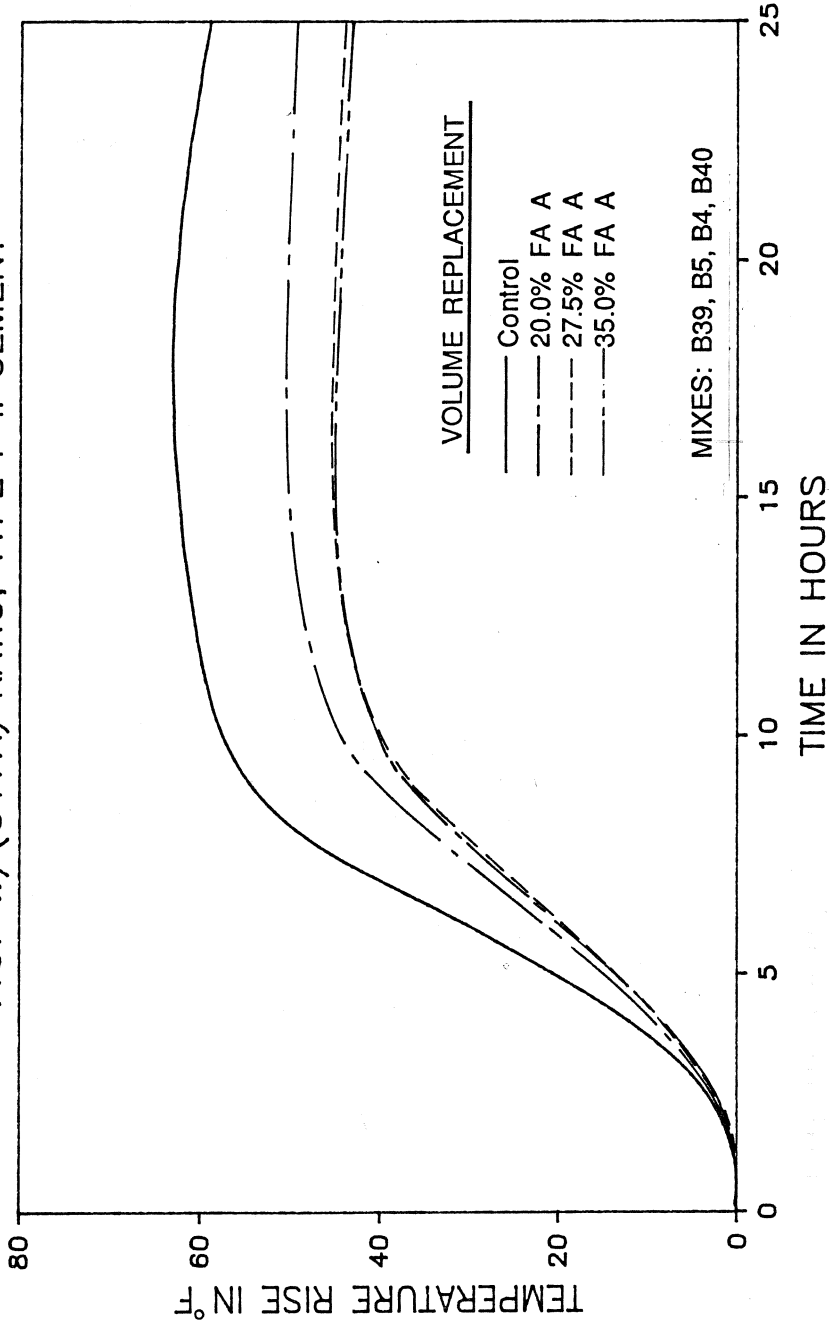

Figure 5.22 Effect of varying content of Type A fly ash on the temperature rise in Type I-II cement mortar.

TYPE A FLY ASH
 .467 W/(C+FA) RATIO, TYPE I-II CEMENT

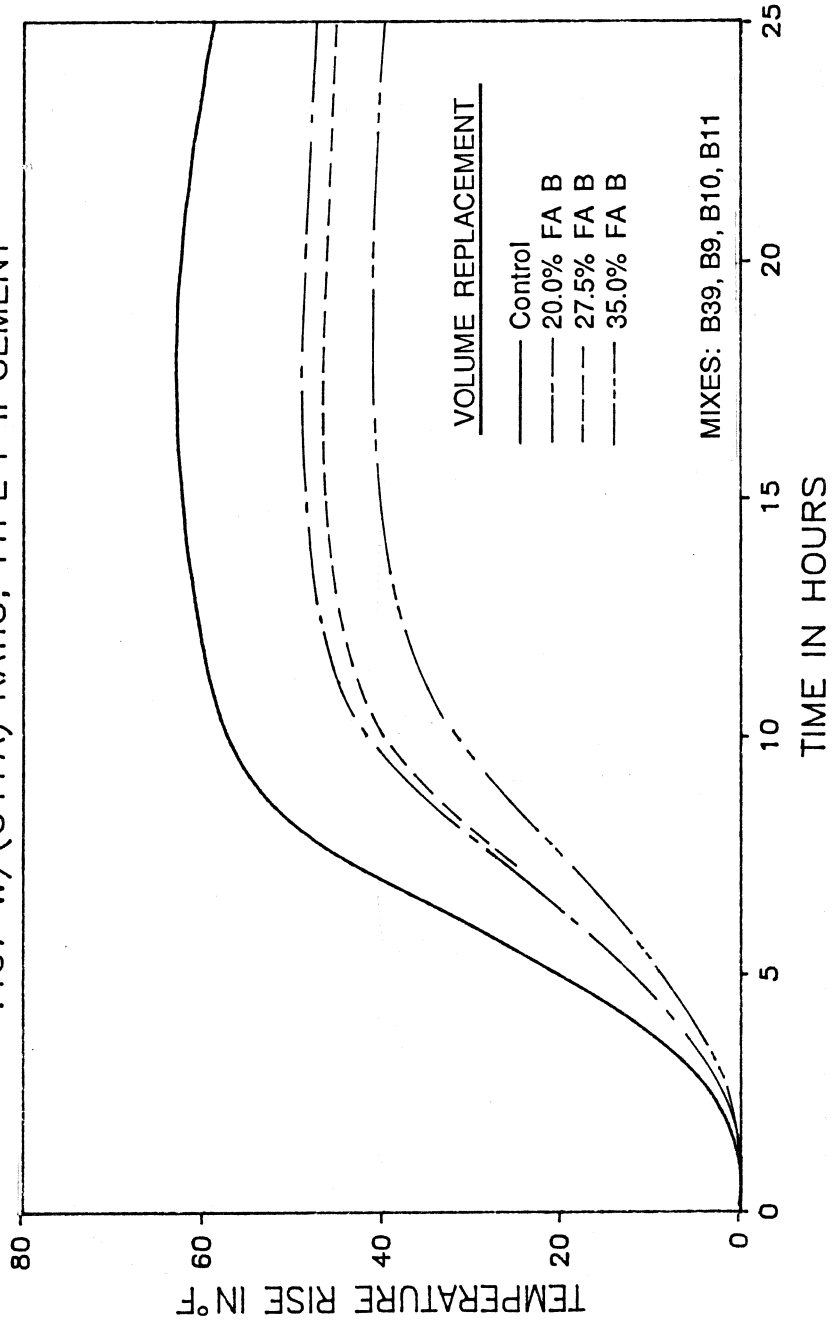

Figure 5.23 Effect of varying content of Type A fly ash on the temperature rise in Type I-II cement mortar.

TYPE B FLY ASH
.467 W/(C+FA) RATIO, TYPE I-II CEMENT

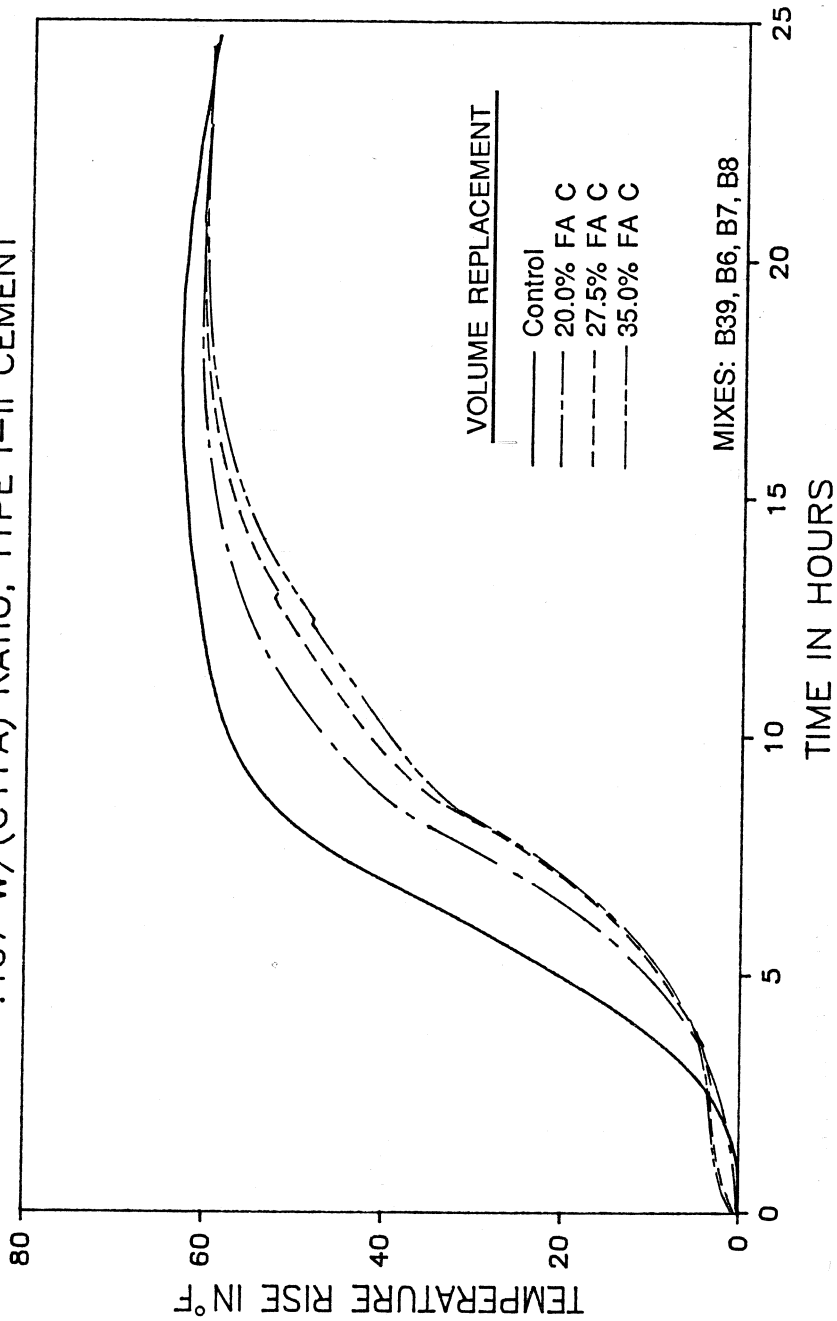

Figure 5.24 Effect of varying content of Type B fly ash on the temperature rise in Type I-II cement mortar.

TYPE B FLY ASH
 .467 W/(C+FA) RATIO, TYPE I-II CEMENT

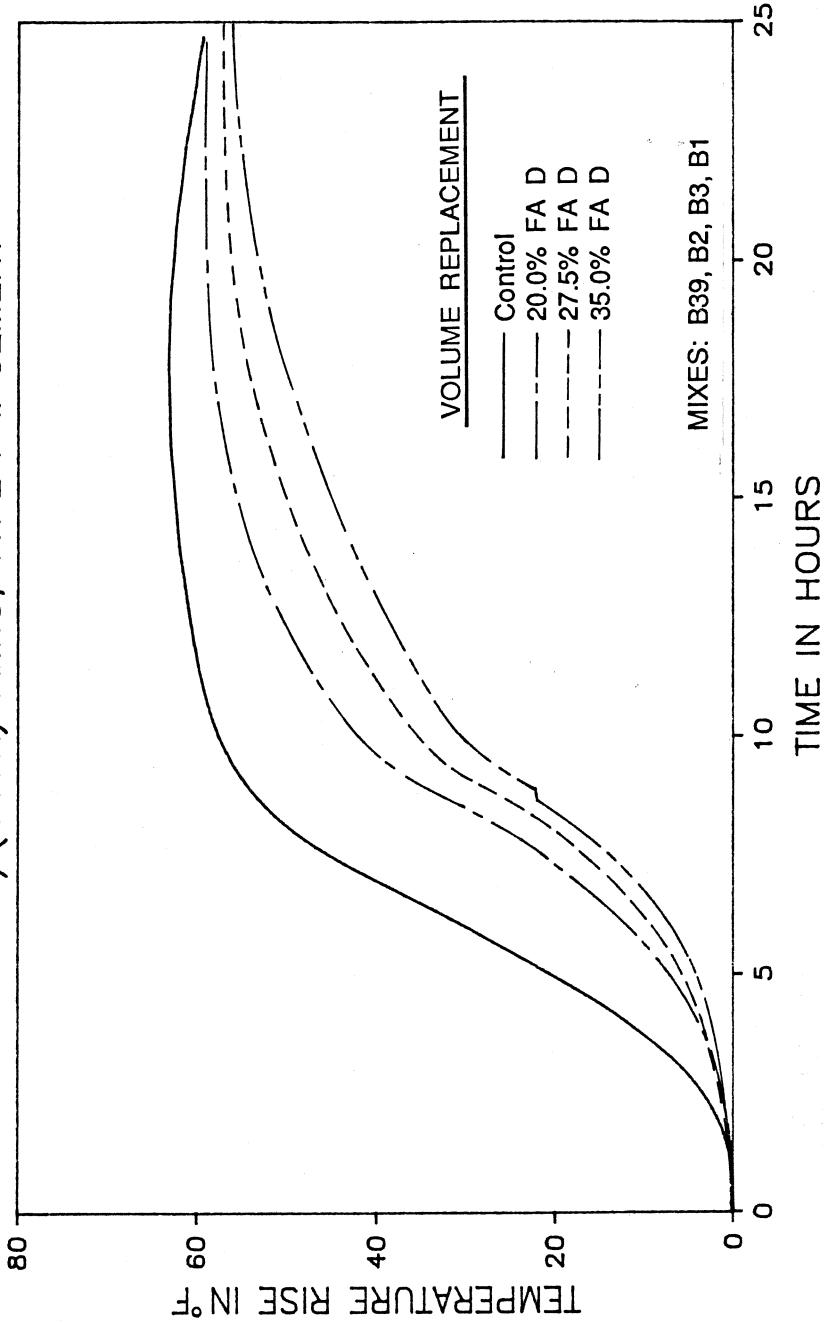

Figure 5.25 Effect of varying content of Type B fly ash on the temperature rise in Type I-II cement mortar.

VARIABLE FLY ASH TYPE
 .467 W/(C+FA) RATIO, TYPE I-II CEMENT

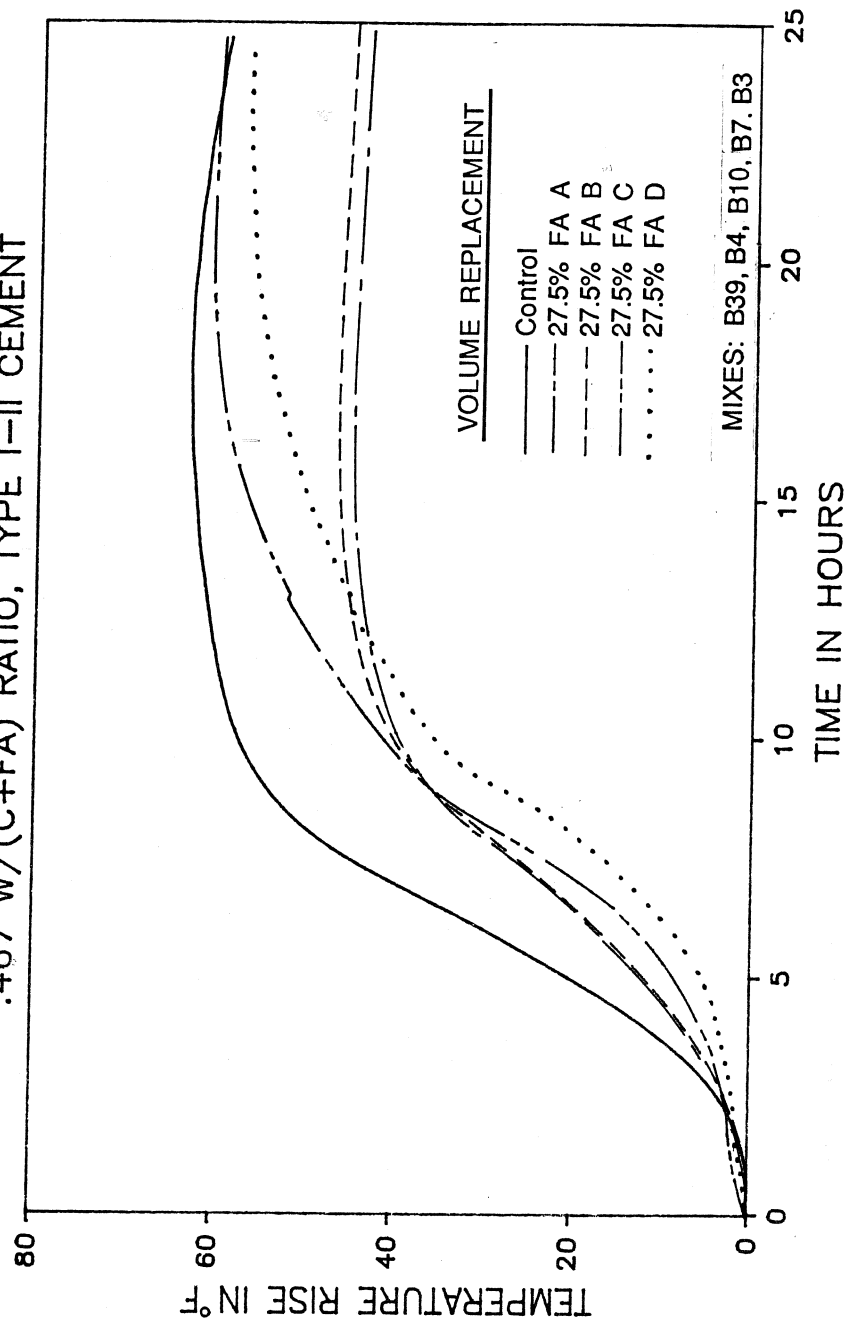

Figure 5.26 Effect of fly ash type on the temperature rise in mortar with 27.5% replacement of Type I-II cement.

TYPE A FLY ASH
.467 W/(C+FA) RATIO, TYPE I CEMENT

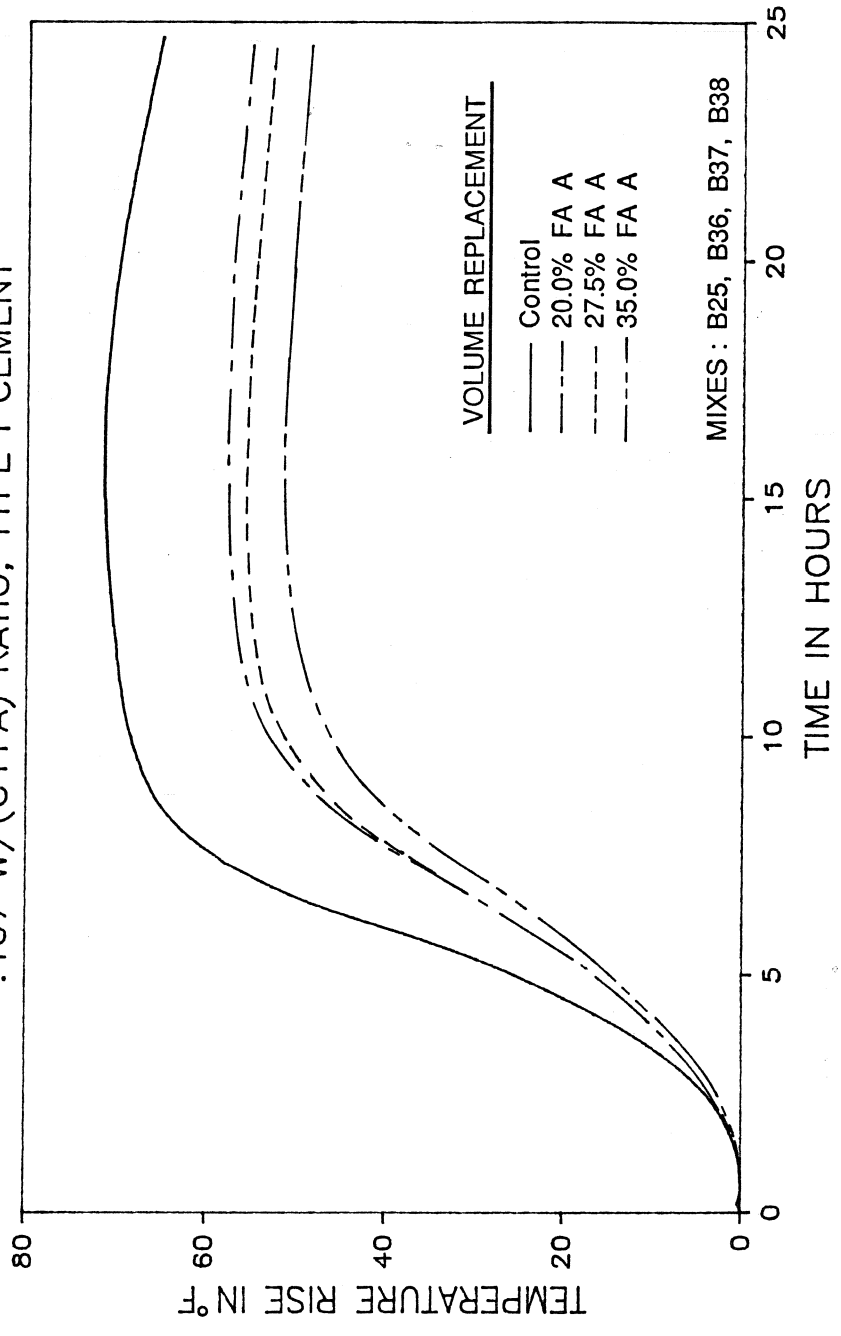

Figure 5.27 Effect of varying content of Type A fly ash on the temperature rise in Type I cement mortar.

TYPE A FLY ASH
.467 W/(C+FA) RATIO, TYPE I CEMENT

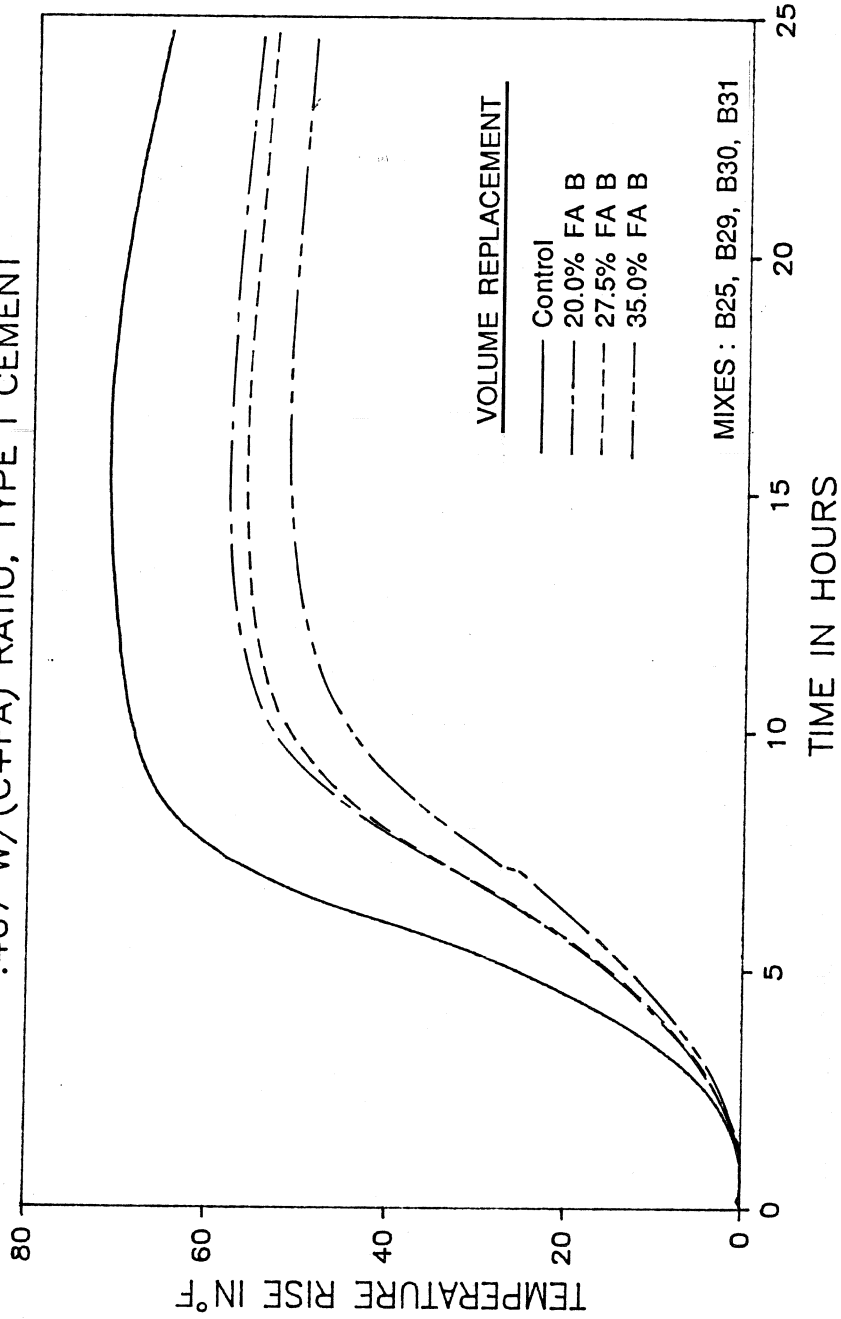

Figure 5.28 Effect of varying content of Type A fly ash on the temperature rise in Type I cement mortar.

TYPE B FLY ASH
 .467 W/(C+FA) RATIO, TYPE I CEMENT

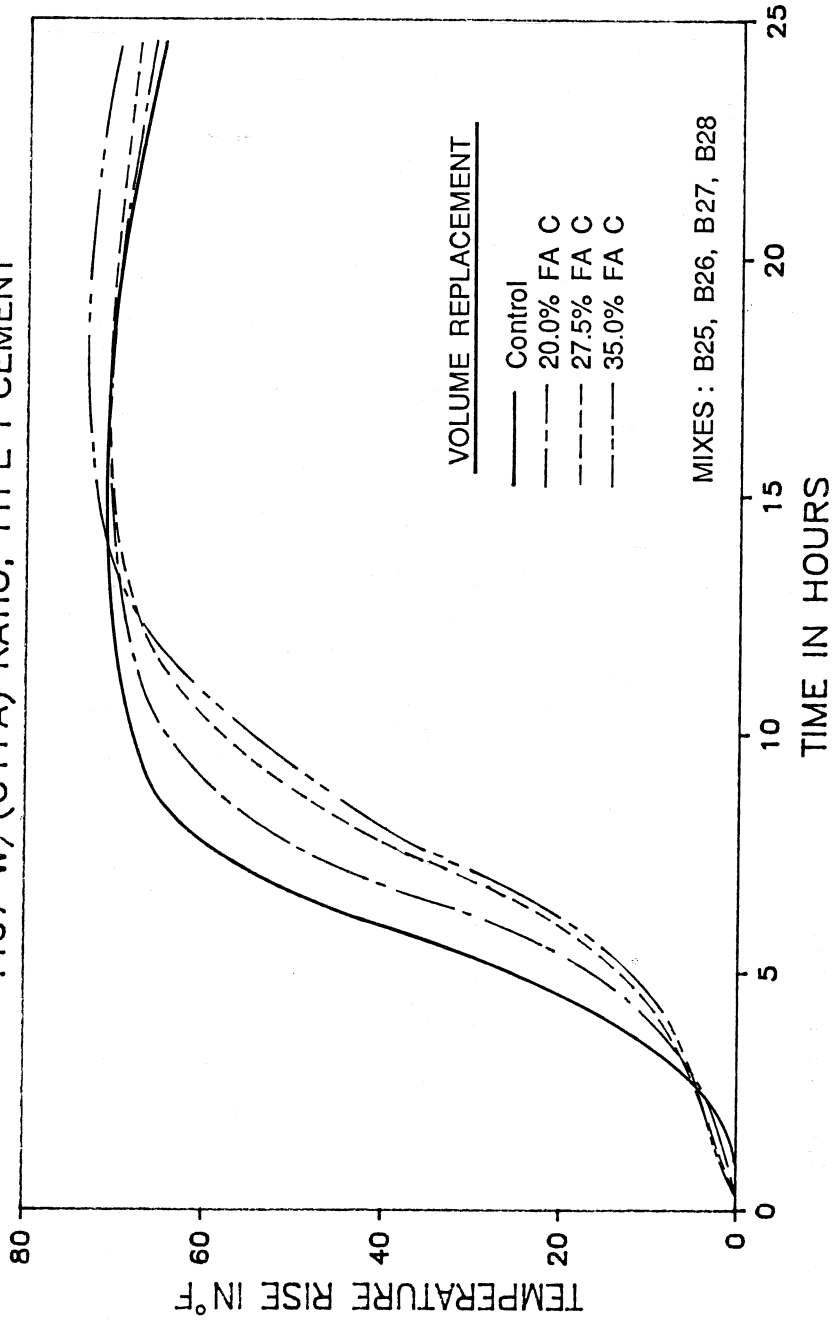

Figure 5.29 Effect of varying content of Type B fly ash on the temperature rise in Type I cement mortar.

TYPE B FLY ASH
.467 W/(C+FA) RATIO, TYPE I CEMENT

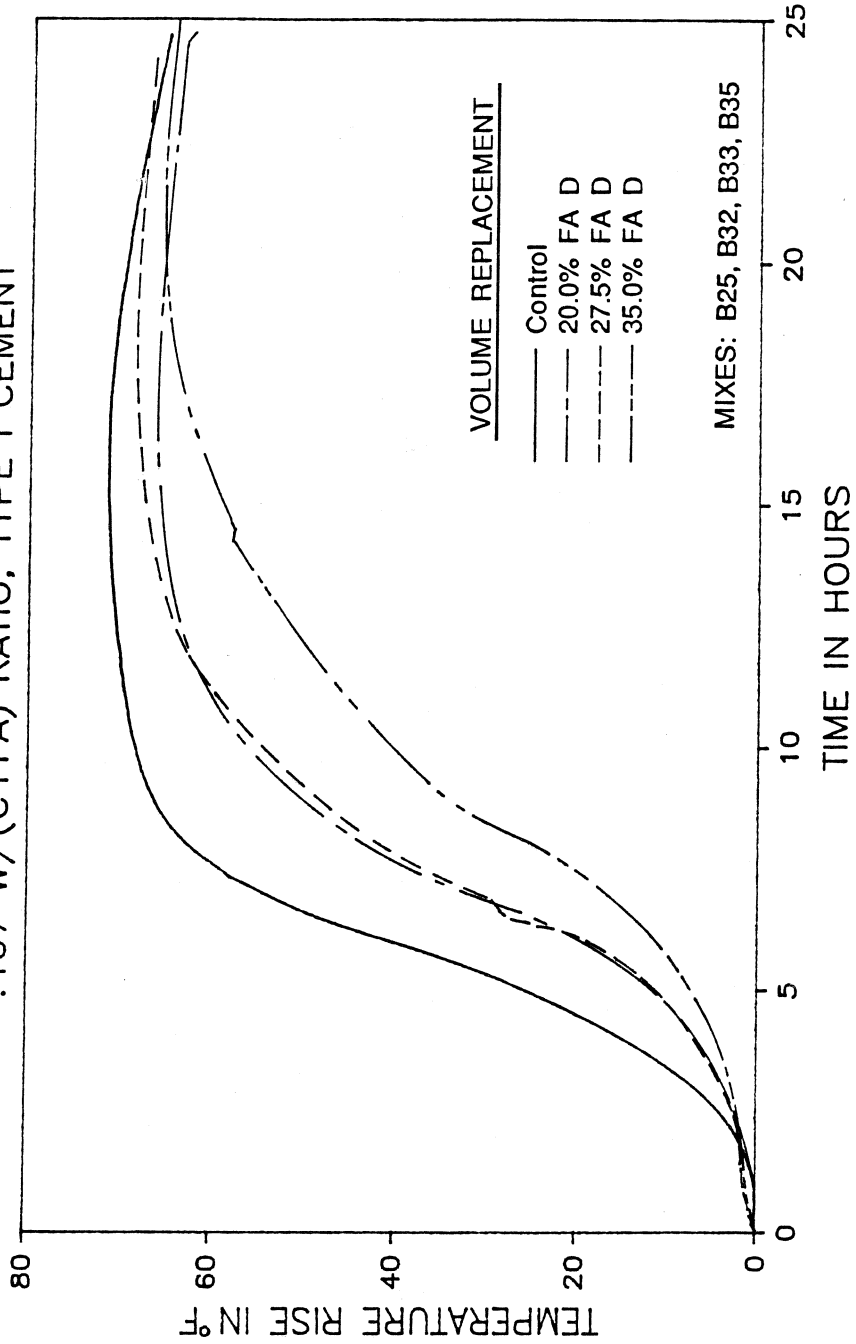

Figure 5.30 Effect of varying content of Type B fly ash on the temperature rise in Type I cement mortar.

VARIABLE FLY ASH TYPE
 .467 W/(C+FA) RATIO, TYPE I CEMENT

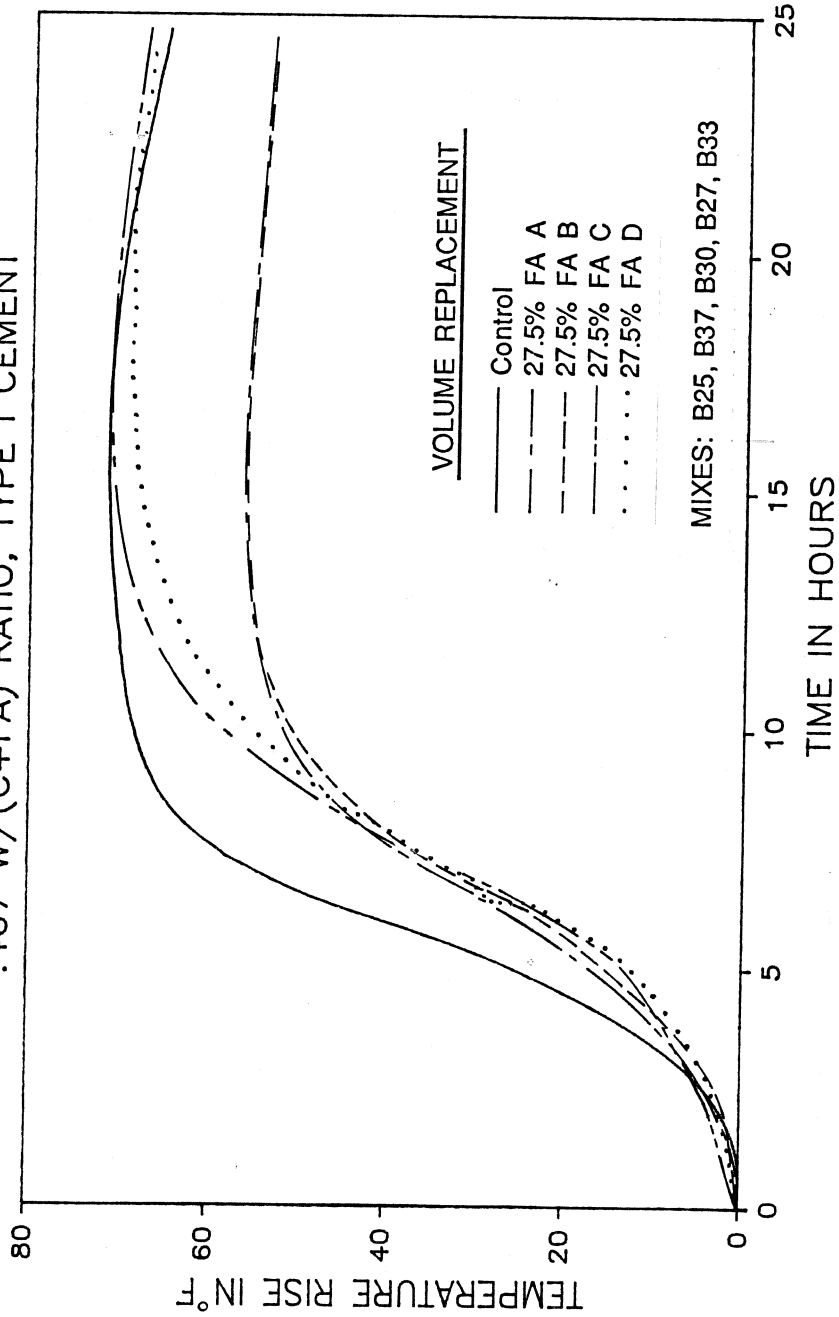

Figure 5.31 Effect of fly ash type on the temperature rise in mortar with 27.5% replacement of Type I cement.

TYPE A FLY ASH
.467 W/(C+FA) RATIO, TYPE III CEMENT

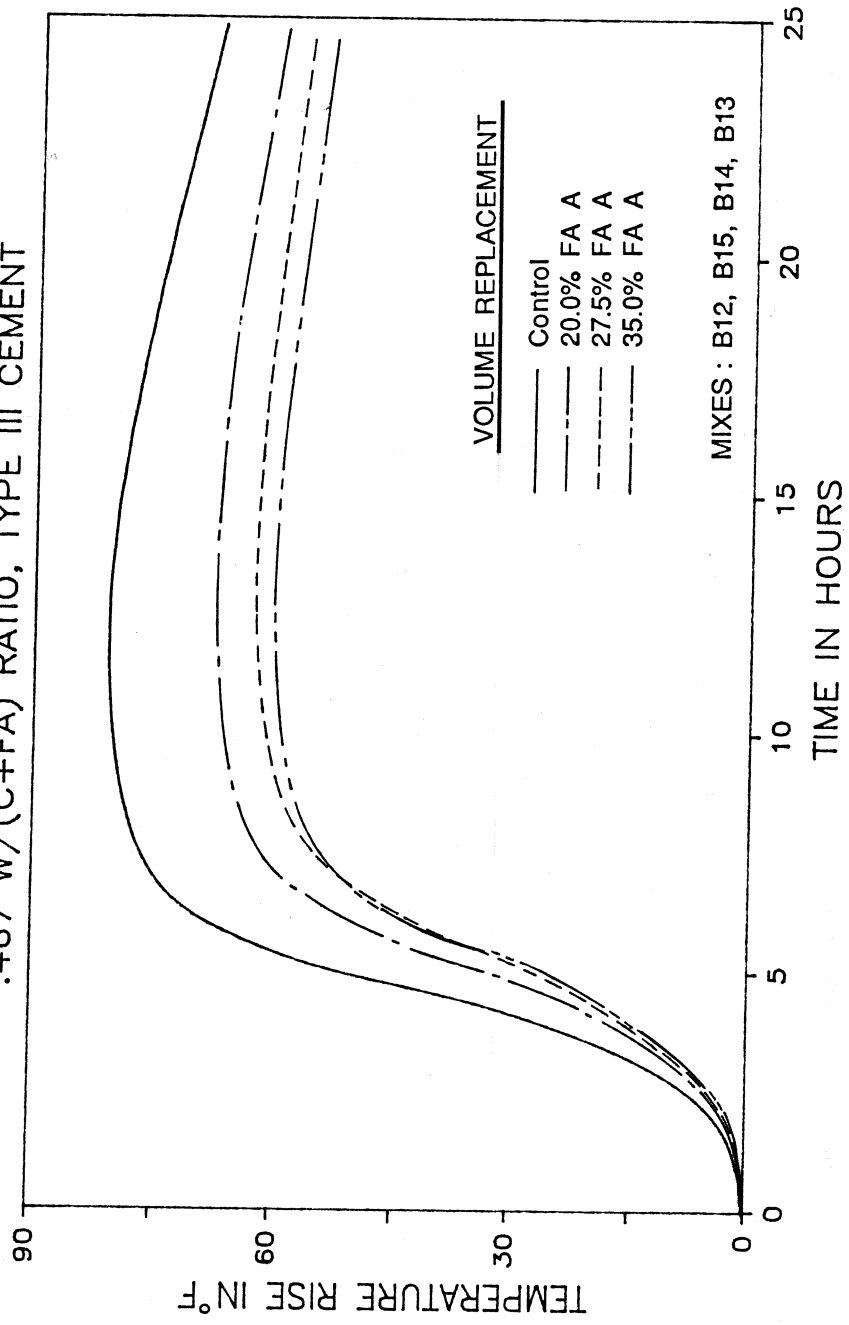

Figure 5.32 Effect of varying content of Type A fly ash on the temperature rise in Type III cement mortar.

TYPE A FLY ASH
.467 W/(C+FA) RATIO, TYPE III CEMENT

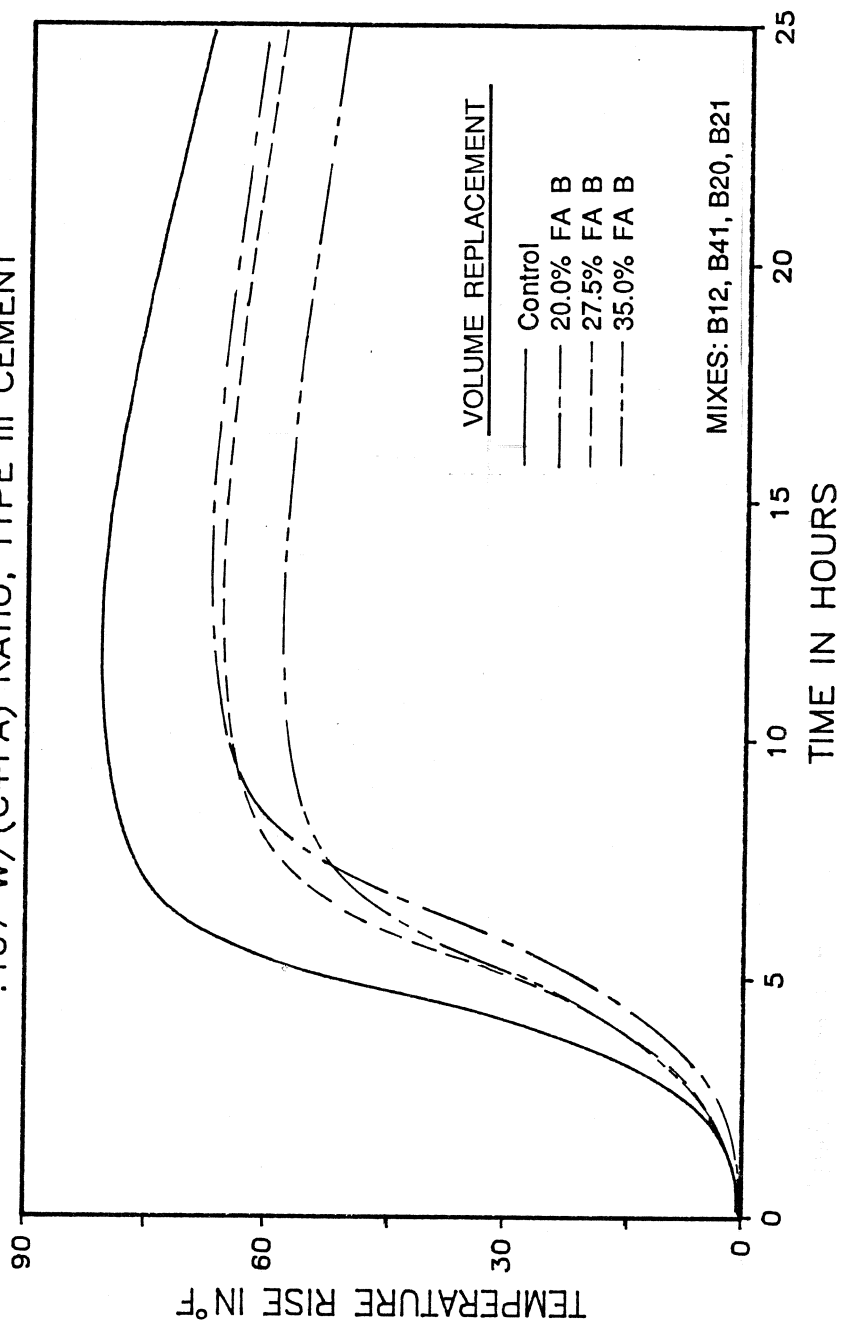

Figure 5.33 Effect of varying content of Type A fly ash on the temperature rise in Type III cement mortar.

TYPE B FLY ASH
 .467 W/(C+FA) RATIO, TYPE III CEMENT

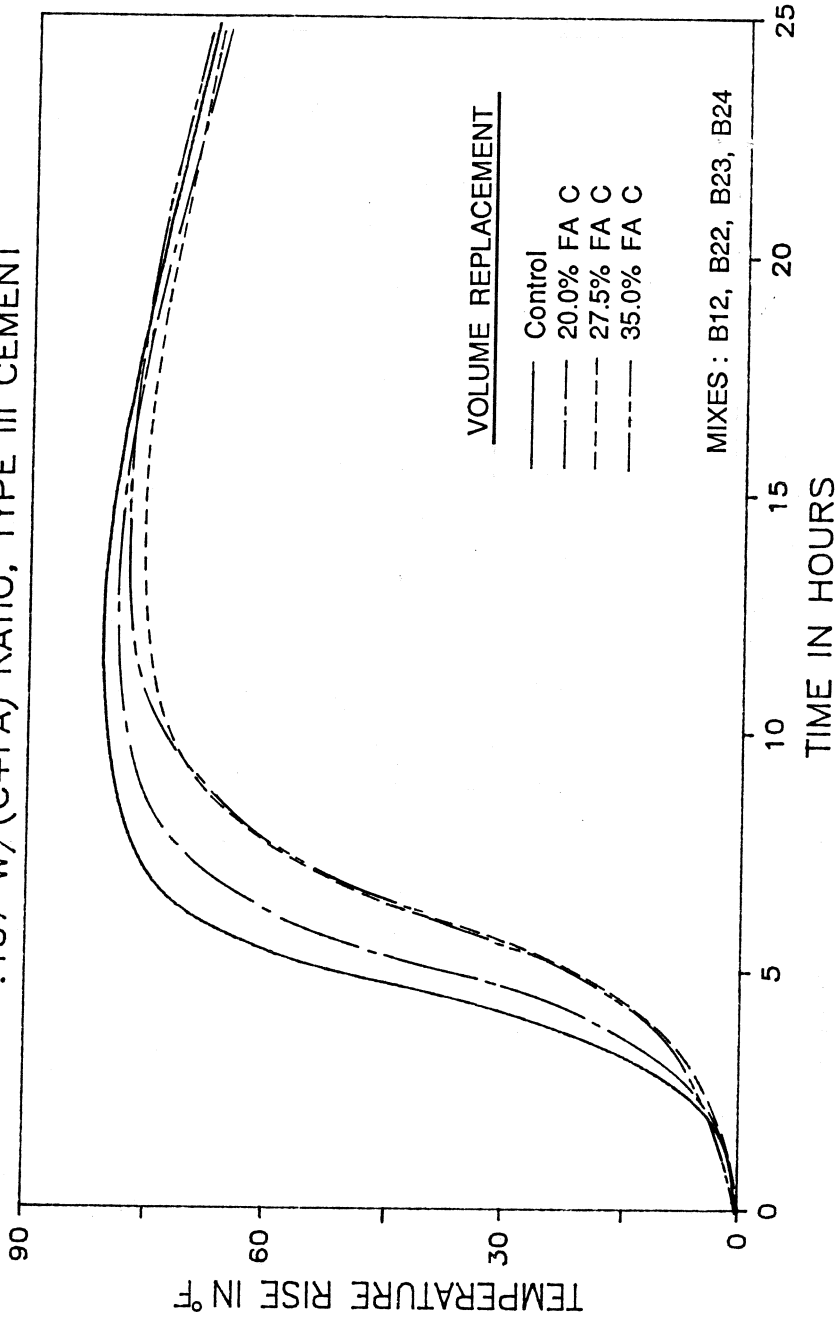

Figure 5.34 Effect of varying content of Type B fly ash on the temperature rise in Type III cement mortar.

TYPE B FLY ASH
 .467 W/(C+FA) RATIO, TYPE III CEMENT

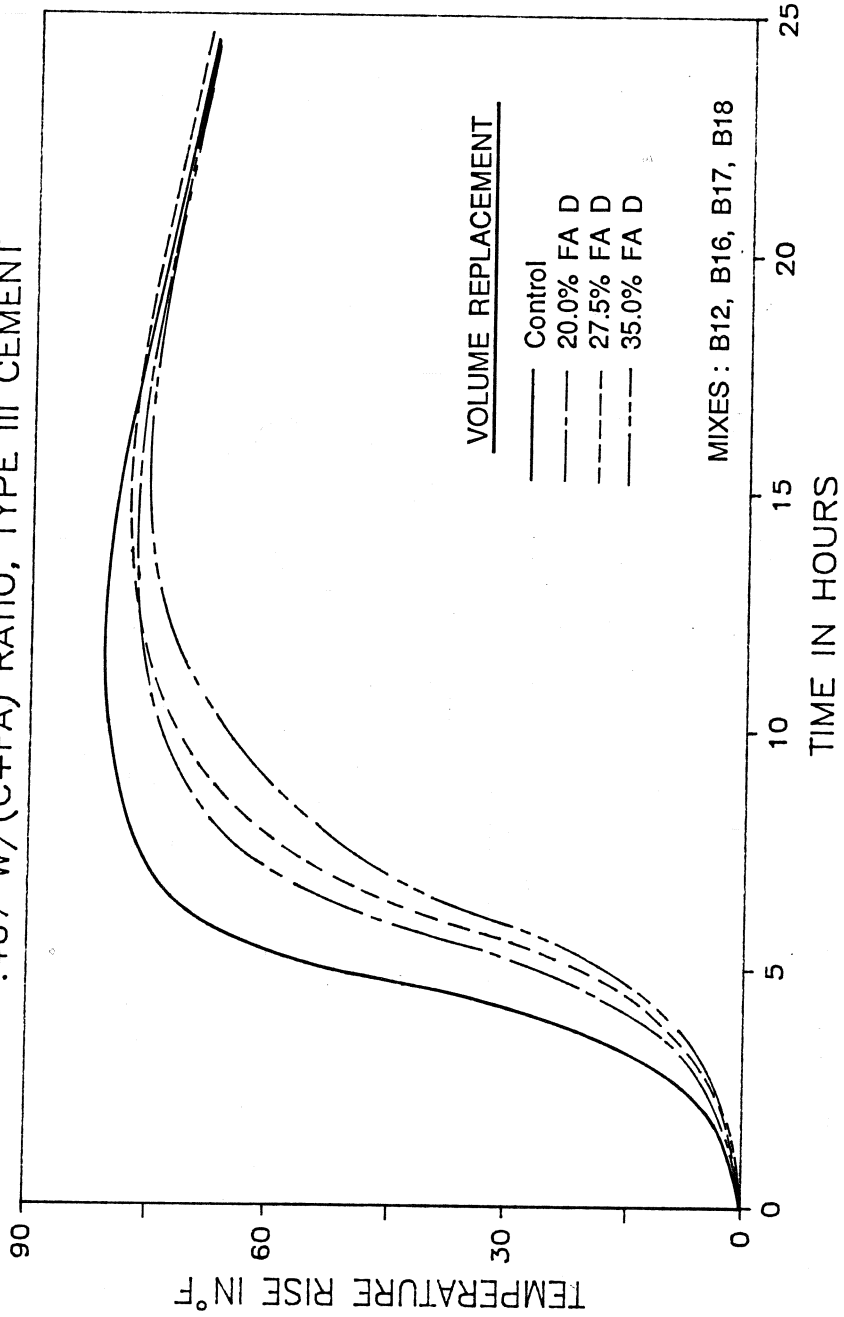

Figure 5.35 Effect of varying content of Type B fly ash on the temperature rise in Type III cement mortar.

VARIABLE FLY ASH TYPE
 .467 W/(C+FA) RATIO, TYPE III CEMENT

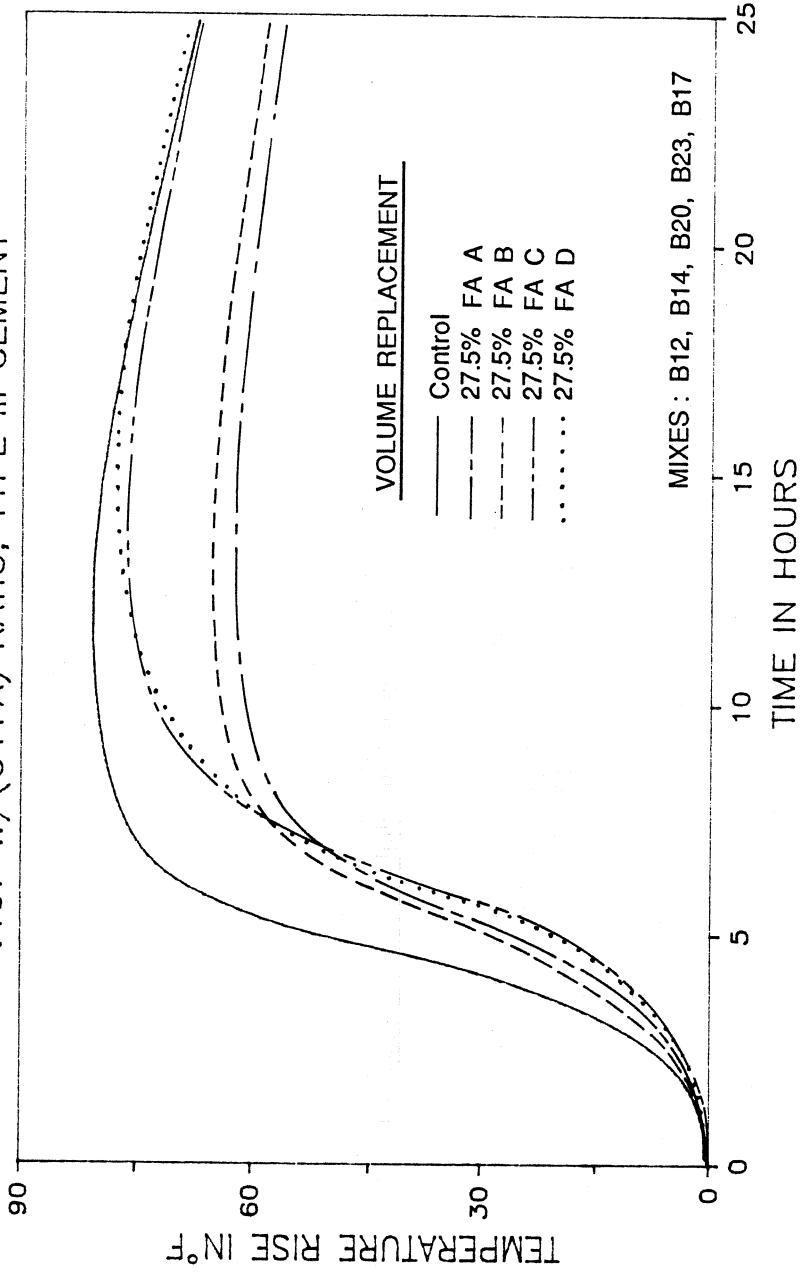

Figure 5.36 Effect of fly ash type on the temperature rise in mortar with 27.5% replacement of Type III cement.

cementitious material ratio ($W/(C+FA)$) by weight, initial temperature, and ambient temperature were held nearly constant.

The temperature profiles are arranged by cement type. The first group is Type I-II, followed by Type I and Type III. Figures 5.26, 5.31, and 5.36, which show the temperature profiles for mortar mixes containing the same cement type and volume of fly ash but variable fly ash type, were constructed from the same curves in the figures in which only the percent replacement was varied. The effect of the variable fly ash type was only plotted for 27.5 percent volume replacement of cement by fly ash because the same trend occurs for 20, and 35 percent replacements. The profiles of the mixes containing chemical admixture are presented in Figures 5.37 to 5.43.

5.4.2.1 Peak Temperature. The peak temperatures for the mortar samples monitored are listed in Tables B.1 to B.4 in Appendix B.

5.4.2.2 Time to Peak Temperature. The time elapsed to reach 95 percent of the peak temperature for the mortar samples monitored are listed in Tables B.1 to B.4 in Appendix B. The same mortar batches were used to measure the time to peak as were used to determine the peak temperature.

5.5 Strength

Compressive strength tests were conducted on 2 in. mortar cubes which had varying cement types, fly ash types and percent replacements, chemical admixture types and dosage rates, and curing conditions. The 7 and 28 day strengths for the cubes are plotted in Figures 5.44 to 5.49 versus the percent replacement of cement by fly ash. The values for those figures and for mixes containing chemical admixture are listed in Tables B.5 to B.7 in Appendix B.

The results of varying the curing temperature (ambient) on the 24 hour compressive strength are as shown in Table 5.2.

All of four of the above mixes were batched with the same $W/(C+FA)$ ratio. FA C is a Type B fly ash.

TYPE I-II CEMENT WITH ADMIXTURE

.467 W/C RATIO, 0% FLY ASH

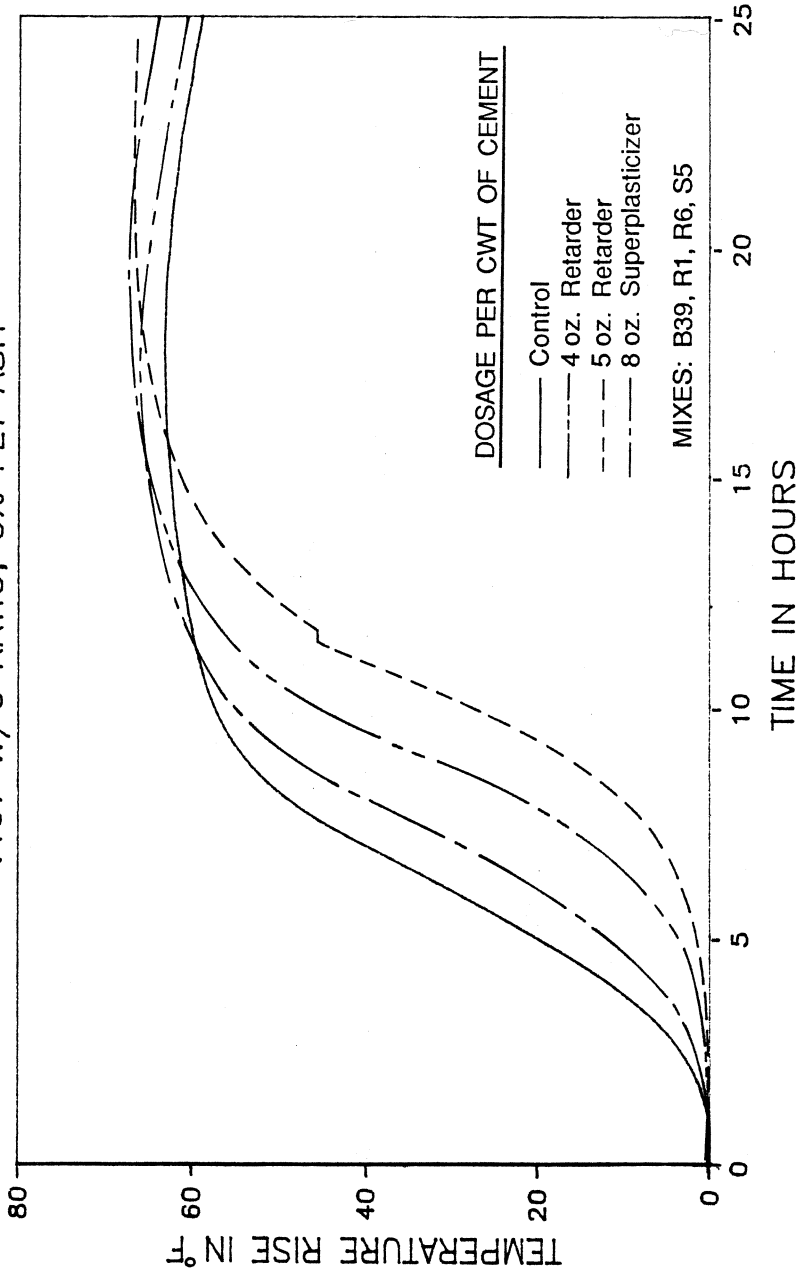

Figure 5.37 Effect of admixture addition on the temperature rise in Type I-II cement mortar.

TYPE I CEMENT WITH ADMIXTURE

.467 W/C RATIO, 0% FLY ASH

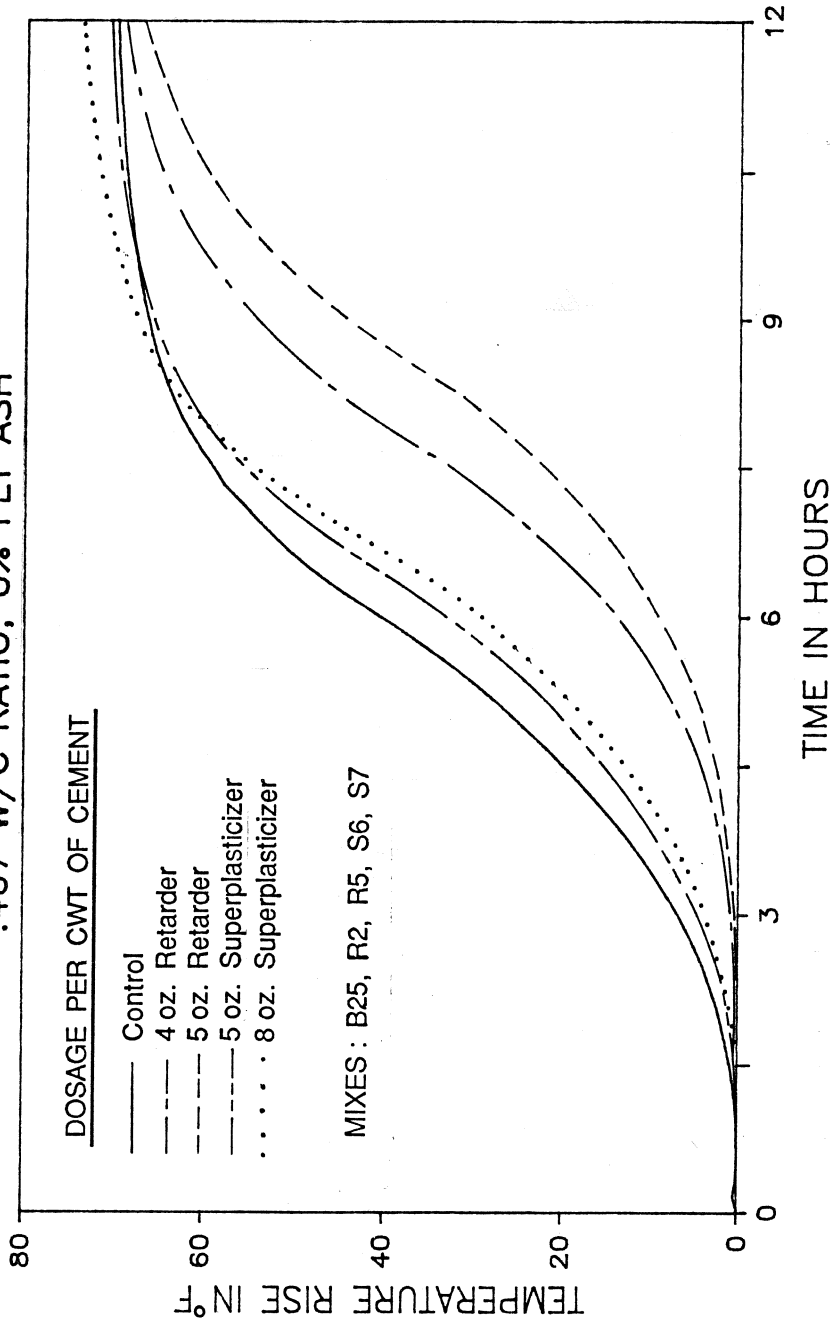

Figure 5.38 Effect of admixture addition on the temperature rise in Type I cement mortar during the initial 12 hours.

TYPE I CEMENT WITH ADMIXTURE
.467 W/C RATIO, 0% FLY ASH

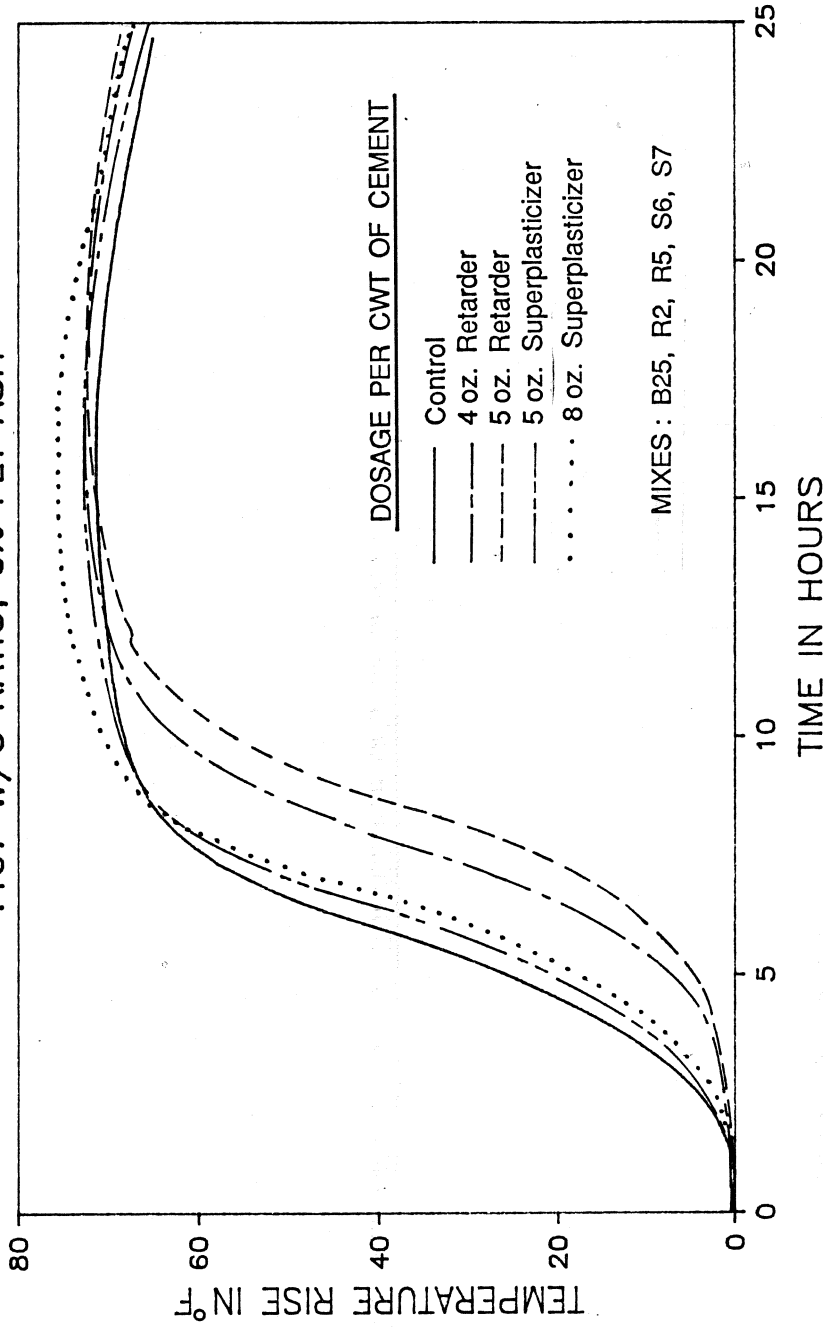

Figure 5.39 Effect of admixture addition on the temperature rise in Type I cement mortar during the initial 25 hours.

TYPE III CEMENT WITH ADMIXTURE
.467 W/C RATIO, 0% FLY ASH

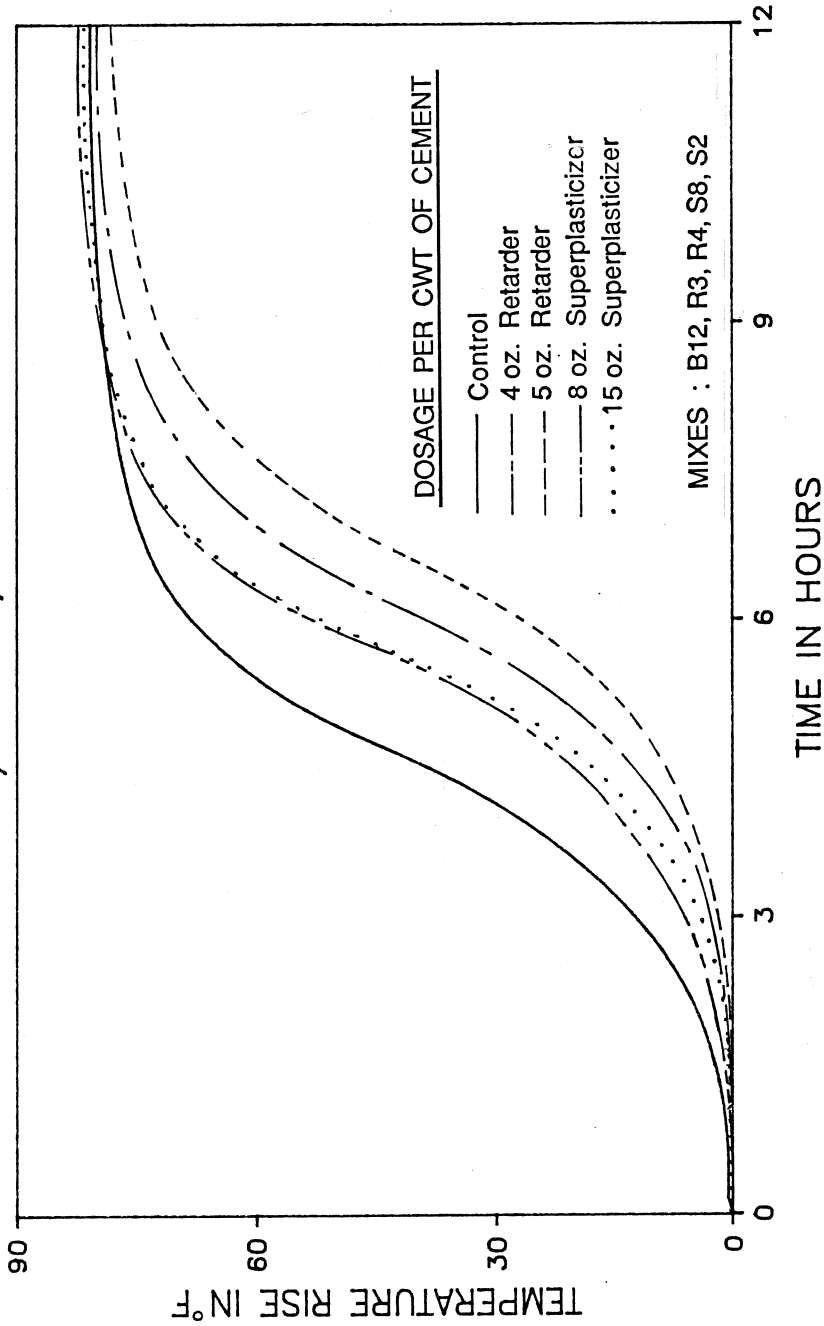

Figure 5.40 Effect of admixture addition on the temperature rise in Type III cement mortar during the initial 12 hours.

TYPE III CEMENT WITH ADMIXTURE

.467 W/C RATIO, 0% FLY ASH

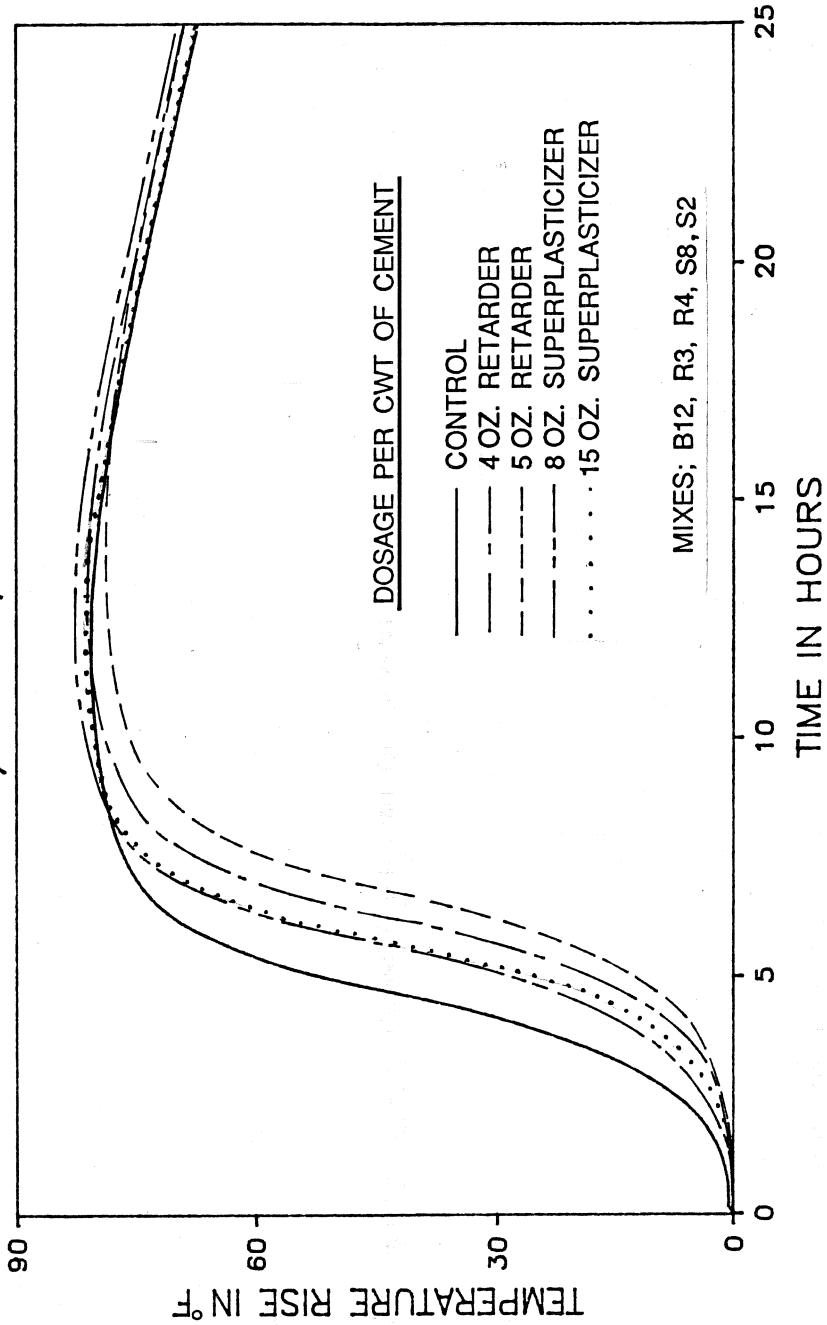

Figure 5.41 Effect of admixture addition on the temperature rise in Type III cement mortar during the initial 25 hours.

FLY ASH AND SUPERPLASTICIZER

.467 W/(C+FA) RATIO, TYPE I CEMENT

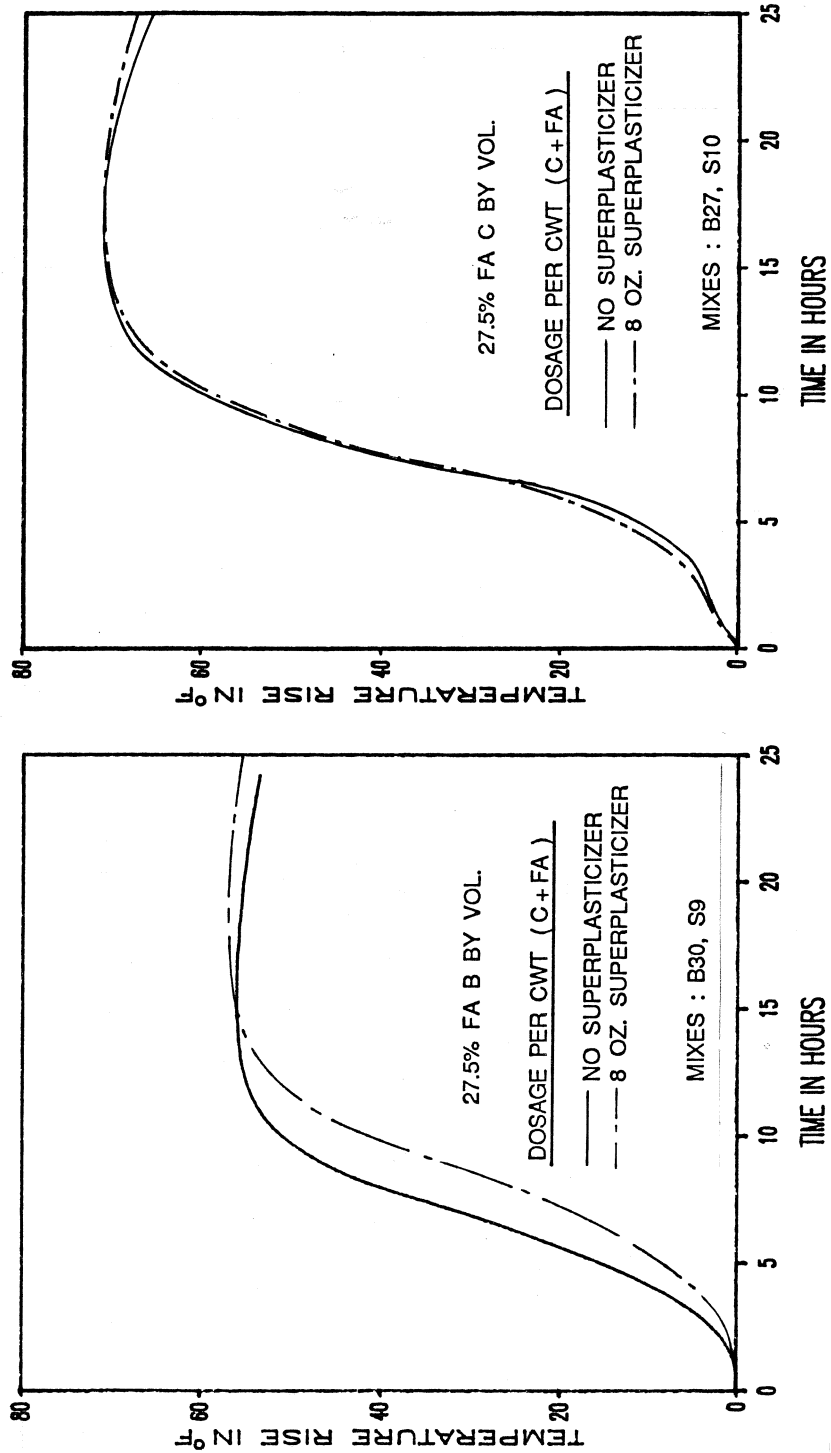

Figure 5.42 Effect of the addition of a superplasticizer on the temperature rise in Type I cement mortar containing fly ash.

FLY ASH AND SUPERPLASTICIZER

.467 W/(C+FA) RATIO, TYPE III CEMENT

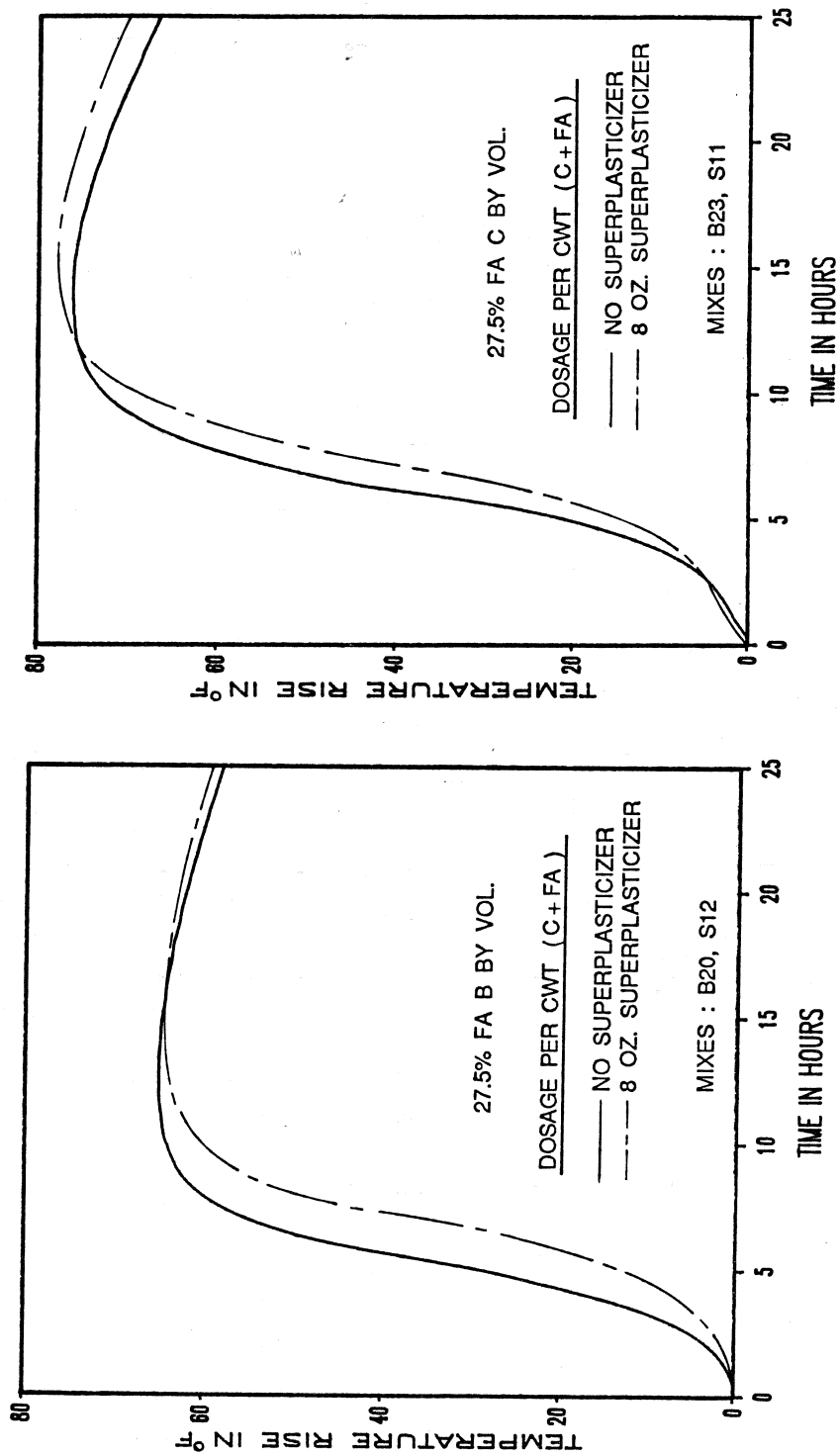

Figure 5.43 Effect of the addition of a superplasticizer on the temperature rise in Type III cement mortar containing fly ash.

7 DAY COMPRESSIVE STRENGTH

.467 W/(C+FA) RATIO, TYPE I-II CEMENT

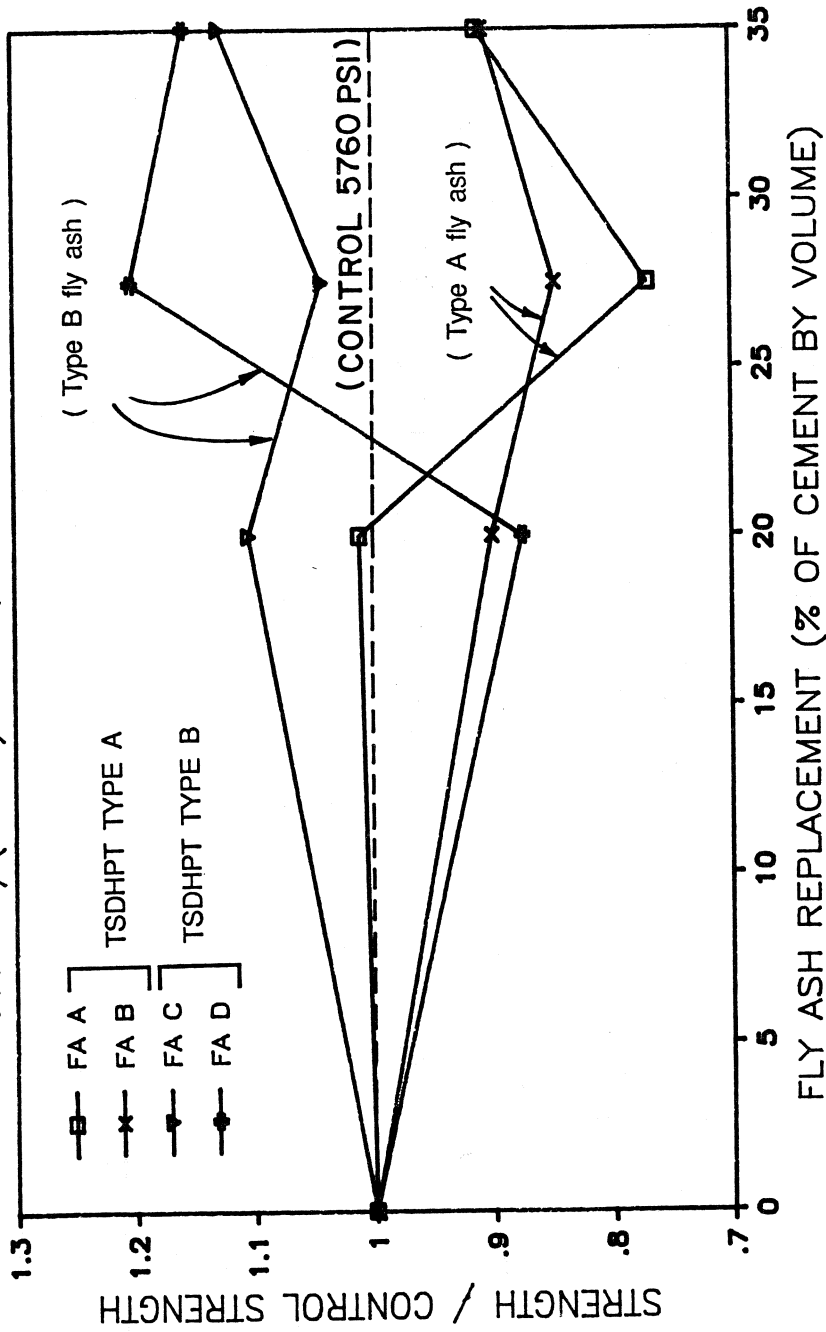

Figure 5.44 Relative compressive strength of Type I-II cement mortars containing fly ash at 7 days.

28 DAY COMPRESSIVE STRENGTH

.467 W/(C+FA) RATIO, TYPE I-II CEMENT

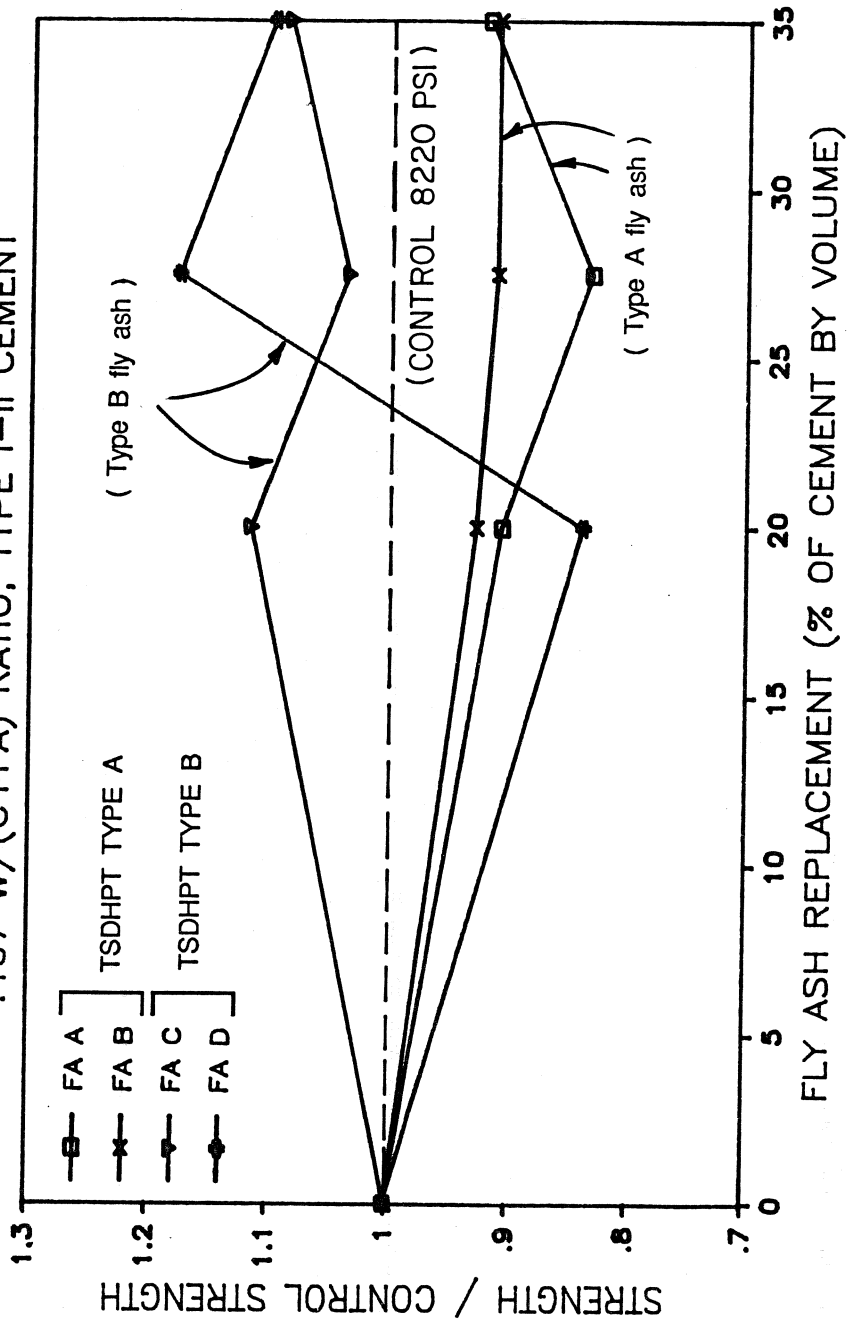

Figure 5.45 Relative compressive strength of Type I-II cement mortars containing fly ash at 28 days.

7 DAY COMPRESSIVE STRENGTH

.467 W/(C+FA) RATIO, TYPE I CEMENT

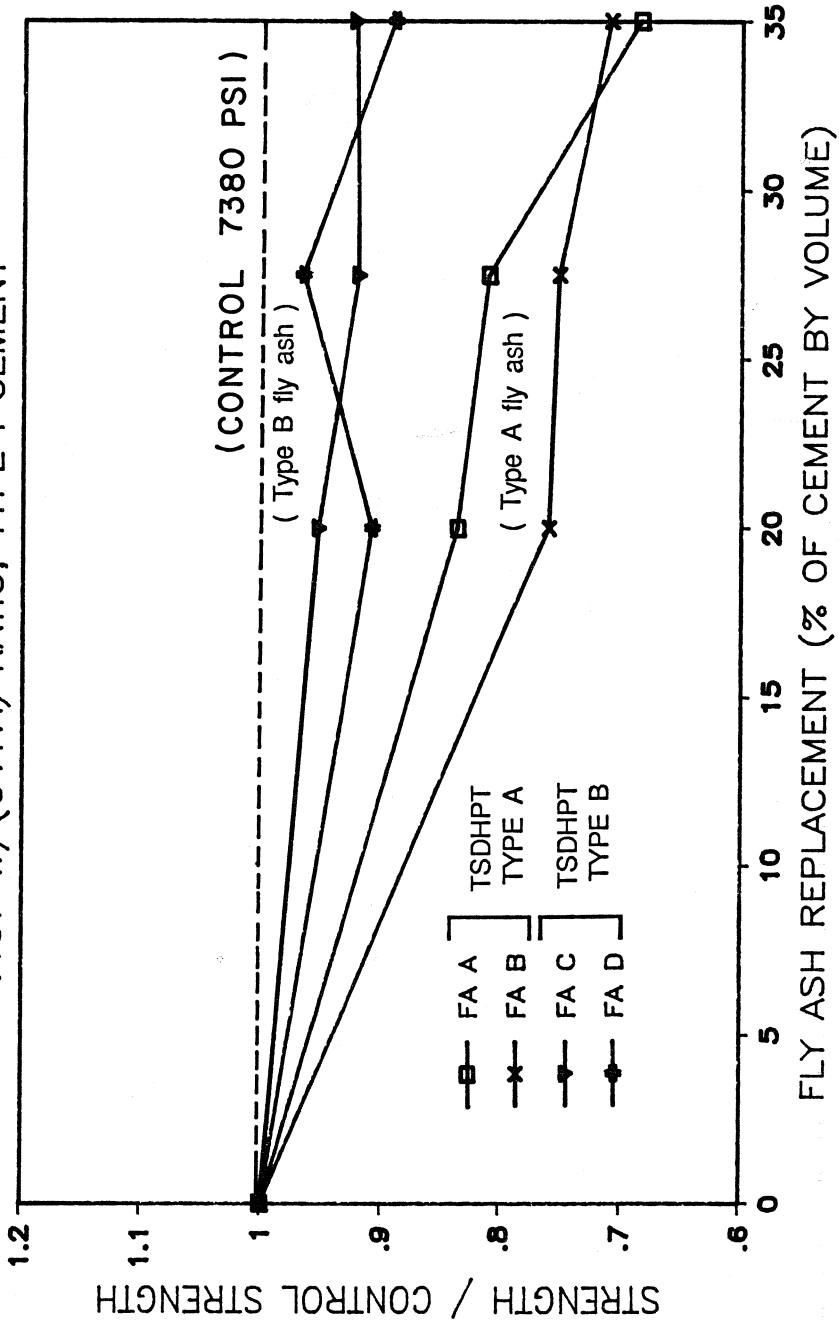

Figure 5.46 Relative compressive strength of Type I cement mortars containing fly ash at 7 days.

28 DAY COMPRESSIVE STRENGTH

.467 W/(C+FA) RATIO, TYPE I CEMENT

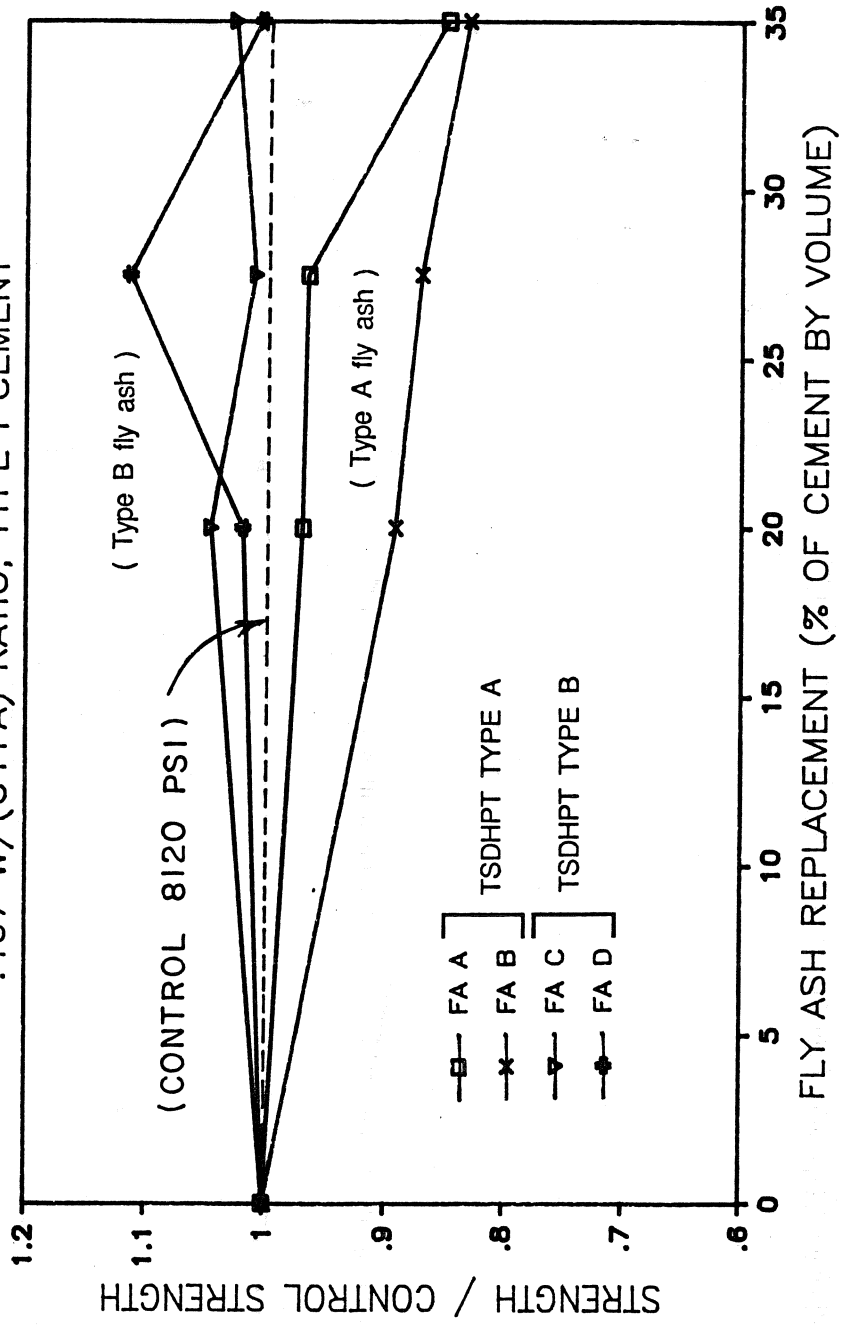

Figure 5.47 Relative compressive strength of Type I cement mortars containing fly ash at 28 days.

7 DAY COMPRESSIVE STRENGTH

.467 W/(C+FA) RATIO, TYPE III CEMENT

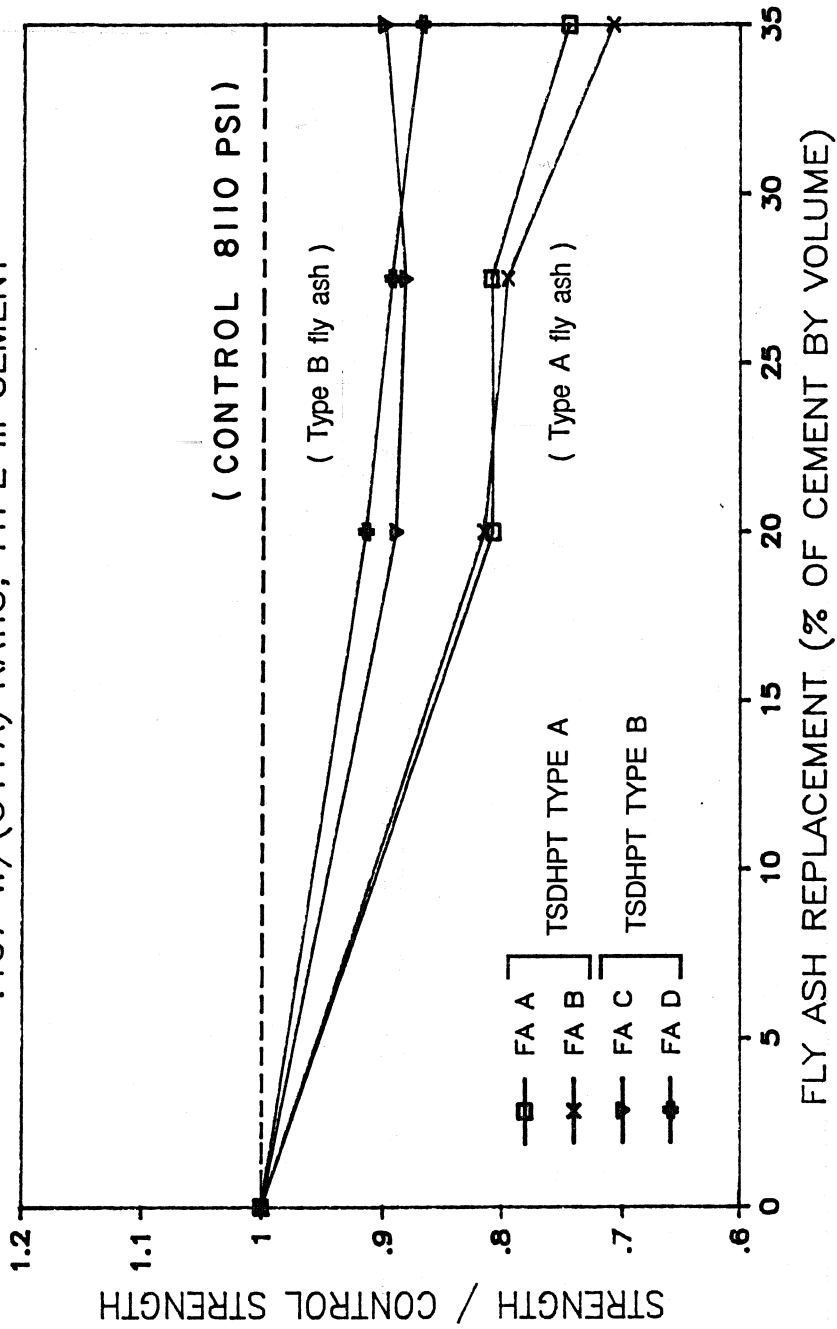

Figure 5.48 Relative compressive strength of Type III cement mortars containing fly ash at 7 days.

28 DAY COMPRESSIVE STRENGTH

.467 W/(C+FA) RATIO, TYPE III CEMENT

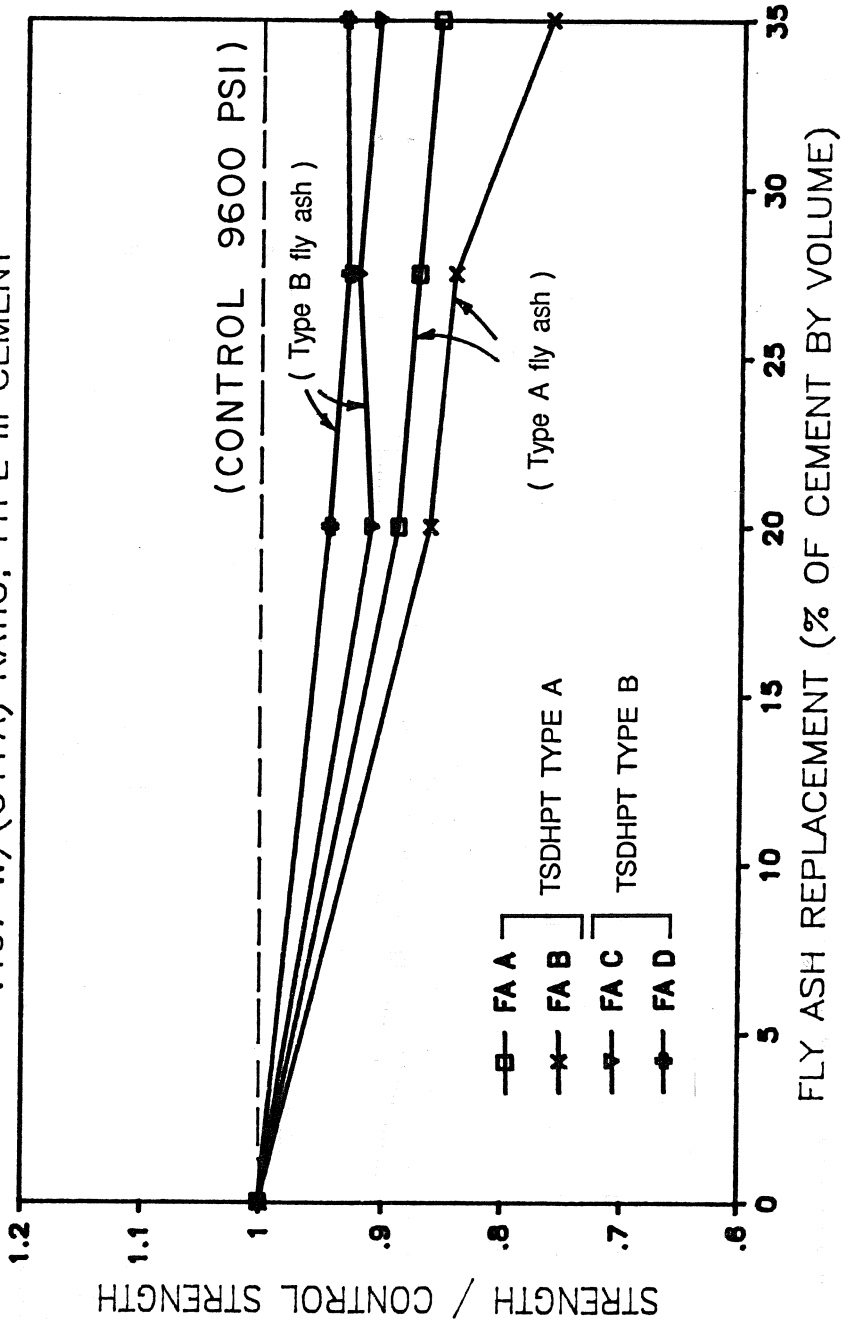

Figure 5.49 Relative compressive strength of Type III cement mortars containing fly ash at 28 days.

Table 5.2 24-Hour compressive strength of mortar.

MORTAR MIX	CURING TEMPERATURE	
	73°F	97°F
	(strength in psi)	
Type III	4580	4670
Type III, 35% FA C	2940	4370
Type I	3060	4650
Type I, 35% FA C	1600	3290

5.6 Flow

Flow tests were conducted on mortar samples containing Type I and Type III cement. Cement was replaced by fly ash from 0 to 35 percent by volume. The results of the cement and fly ash mortar flow tests are shown in Figures 5.50 and 5.51.

The results of the flow tests with the addition of a water reducer/retarder or superplasticizer are shown in Table B.8 in Appendix B along with the flows for the mixes without any chemical admixture.

FLOW OF MORTAR WITH FLY ASH

.467 W/(C+FA) RATIO, TYPE I CEMENT

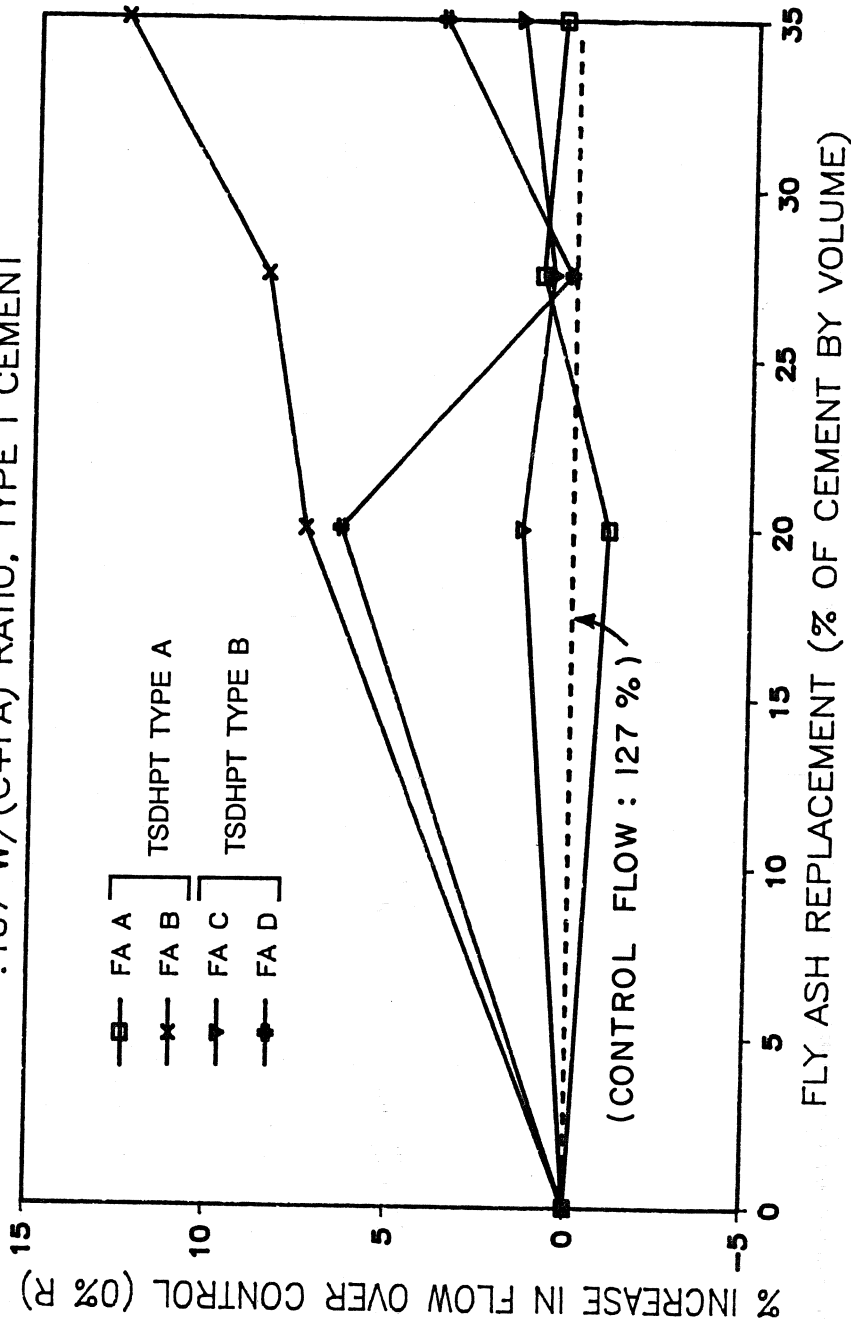

Figure 5.50 Relative flow of Type I cement mortars containing fly ash.

FLOW OF MORTAR WITH FLY ASH

.467 W/(C+FA) RATIO, TYPE III CEMENT

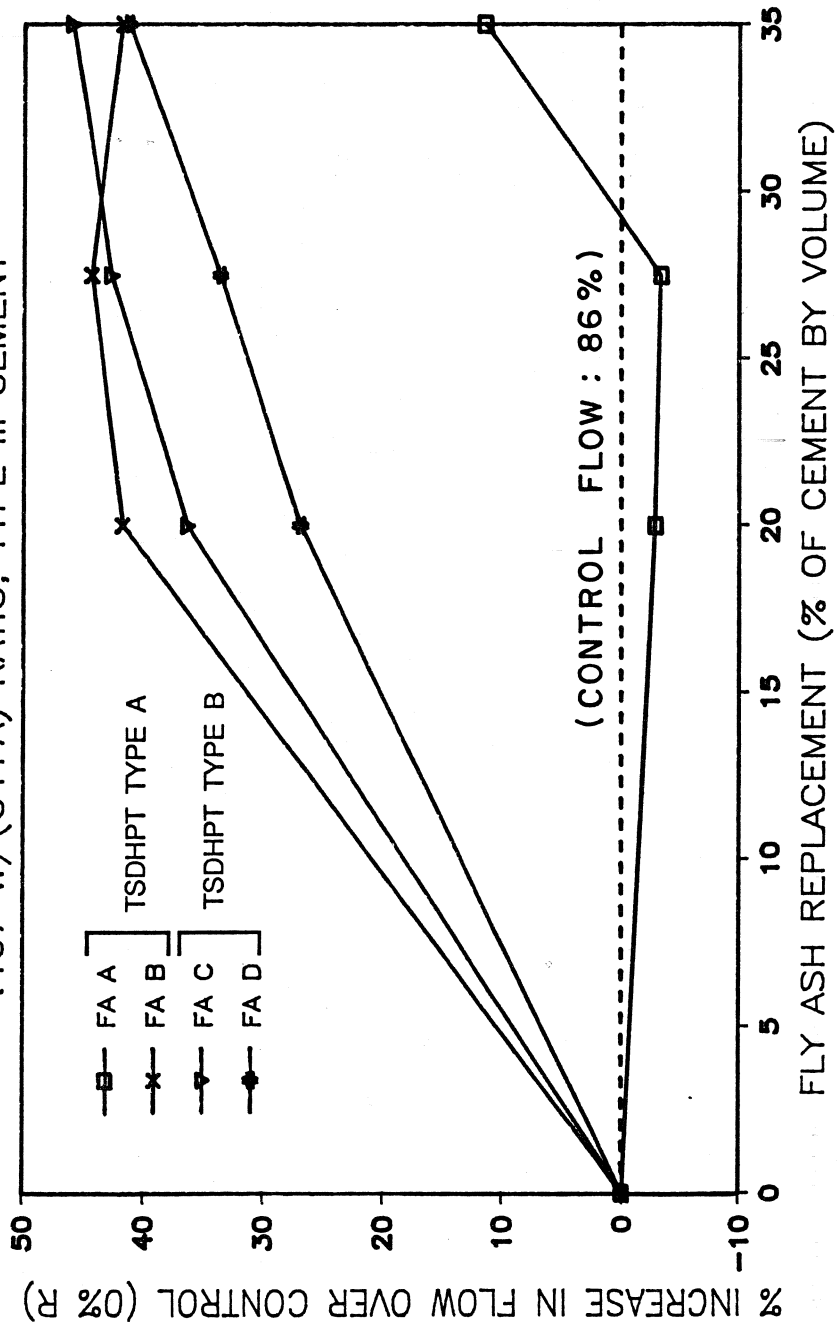

Figure 5.51 Relative flow of Type III cement mortars containing fly ash.

CHAPTER 6

DISCUSSION OF TEST RESULTS

6.1 Introduction

In this chapter all of the experimental test results are discussed, except the test results involving the addition of chemical admixture. To avoid confusion, the test results from the mortar mixes containing chemical admixture are discussed in Chapter 7.

The cements, fly ashes, and admixtures used in this study are commercially available throughout Texas and provide a basis for comparison of physical and chemical properties for cements, fly ashes, and admixtures in general. However, it should be noted that other cements, fly ashes, and chemical admixtures may produce different results. Thus, for different materials it is recommended to prepare trial batches before construction.

6.2 Thermal Gradient

The thermal gradients shown in Chapter 5 illustrate two important points:

- 1) The temperature gradient on a vertical cross section does not vary linearly from the mid-depth temperature to the surface temperature.
- 2) While covering the exposed concrete surface allowed a higher internal concrete temperature to develop, the difference between the mid-depth and surface temperature (temperature drop) was not as great in the covered specimen as for a similar exposed specimen.

All three of the concrete specimens monitored show that the temperature gradient is insignificant over the middle portion of the member and very steep towards the surface. That finding is in agreement with the isotherms shown in Figure 3.4. In the 4 ft cube monitored in Test 1, 86 percent of the temperature drop occurred over the top 1 ft of depth despite being covered. In both of the 6 in. x 6 in. x 20 in. beams, 93 percent of the temperature drop occurred over the top 2 inches regardless of whether the surface was covered or exposed. For the two 18 in. deep samples, 72 percent of the temperature drop occurred over the top 1 in. for the covered sample and 48 percent for the uncovered sample. Thus it is clear that the temperature drop within a concrete member from mid-depth to the exposed surface is not linear, but rather most of the temperature drop occurs near the exposed concrete surface.

Tests 3 and 4 conducted under field conditions indicate that the total temperature drop is decreased by covering the top surface of the concrete. The covering used consisted of damp burlap and plastic, which is commonly used to cure concrete in the field. The covered surface allows the interior concrete to reach a higher temperature by slowing the loss of heat generated from the hydration of cement and from solar radiation. The covering also insulates the concrete surface from the ambient temperature cycles which decreases the temperature drop between the mid-depth and the covered surface.

6.3 Test Parameters

6.3.1 Correlation of Samples to Mass Concrete. The heat loss in the small samples caused a peak temperature difference between the 4 ft concrete cube and small samples of 27oF for Test 1 and 28oF for Test 2. The lower temperature in the small sample is partially due to heat lost to the environment. However, the majority of heat loss occurs in heating up the polyurethane foam which is snug with the plastic cylinder containing the sample.

The greatest difference between companion samples was approximately 2°F. The recorded difference in temperatures between the same mix in different insulated boxes is less than the error associated with temperature measurement by J-type thermocouples. Thus, the insulated boxes provide a means predicting the maximum temperature in mass concrete specimens from small specimens.

6.3.2 Ambient Temperature. Variations in the ambient temperature within the range of 68 to 84°F has a small effect on the order of 3 to 4°F on the maximum temperature rise. The lower ambient temperature did, however, increase the time to 95 percent of the peak temperature by 1.2 hours. That increase in time may be due to the lowering of the mortar temperature at early ages caused by placing the mortar in an environment colder than the mortar's initial temperature. The lowering of the mortar's initial temperature resulted in a slower rate of hydration at early ages.

6.3.3 Initial Mix Temperature. A similar trend was seen from varying the initial mix temperature as was seen from varying the ambient temperature. The temperature rise was not altered by the initial temperature regardless of the percent replacement of cement by fly ash, and the fly ash type. The time to the peak temperature was increased as the initial temperature decreased in all cases tested due to the slower rate of hydration at lower temperatures.

The fact that the initial concrete temperature affects the rate of heat generation is important for concrete in a nonadiabatic environment. Precooling of concrete can reduce the internal temperature rise by decreasing the rate of heat generation. The lower rate of heat generation provides a longer time for heat to dissipate which decreases the potential for thermal cracking due to a thermal gradient within a concrete member.

6.3.4 Cement Type and Content. The greater peak temperature of the Type III cement as compared to that for the Type I cement in Figure 5.16 shows the effect of cement fineness on hydration. Both cements have the same chemical composition, but the Type III cement is ground finer. The finer the cement particles, the greater the particle surface area. The greater surface area exposed to the mixing water increases the rate of hydration, particularly at early ages. The Type I-II cement was slower reacting than the Type I cement primarily due to the lower tricalcium aluminate content and lower particle surface area, as determined by the Blaine Air Permeability Test, of the Type I-II cement. The chemical and physical properties of the cements are given in Tables A.6 - A.8 in Appendix A.

Figure 5.17 shows that as the cement content increases, the temperature rise also increases. For Type I cement mortars containing no fly ash, the temperature rises were 4.1, 4.3, and 4.6°F per percent volume of cement per unit volume of mortar for mixes with 10.7, 16.8, and 23.6 percent volume of cement per unit volume of mortar. The slight increase in the temperature rise per pound of cement as the cement content increased is mainly due to an increase in the rate of hydration associated with higher temperatures.

6.3.5 Water to Cementitious Materials Ratio. The four tests conducted on the effect of the $W/(C+FA)$ ratio on the temperature rise of mortar covered a wide range of cement types, fly ash types, replacement percentages, and water to cementitious materials ratios. Those four tests showed no apparent trend.

Other research has shown that the initial W/C ratio, ranging from 0.157 to 0.80 by weight, does not have a significant effect on the rate of hydration of Portland cement over the initial 20 hours. ^[42] At later ages, the rate of hydration decreases as the water to cement ratio decreases. The effect of the W/C ratio at later ages may be due to the decrease in aqueous medium which transports the reactants to the surfaces where hydration occurs, the decrease in space available for hydration products, or simply an insufficient supply of mixing water to continue hydration.

Mortars may be batched to achieve a constant compressive strength, flow, or $W/(C+FA)$ ratio. For field applications concretes are designed to achieve a particular strength and workability. In this study the water to cementitious materials ratio was held constant for all mortar mixes.

6.4 The Effect of Fly Ash on the Temperature Rise in Mortar

6.4.1 Peak Temperature. As shown in Figures 6.1 to 6.3, the effect of the replacement by volume of cement by fly ash on the peak temperature rise of mortar appears to be best categorized by fly ash type.

For all three cement types tested, Type A fly ashes (FA A and FA B) significantly decreased the mortar peak temperature rise. Regardless of cement type, both Type A fly ashes had a similar effect on the temperature rise. For example, mortars with 35 percent replacement of cement with either of the Type A fly ashes produced similar decreases in peak temperature rise compared to the corresponding control mixes of $20^{\circ}\text{F} \pm 2^{\circ}\text{F}$. For all three cement types, the temperature rise decreased with an increase in the Type A fly ash content. Thus, the addition of Type A fly ash consistently decreased the peak mortar temperature rise. That decrease appears to be due to the inertness of the Type A fly ashes at early ages.

The replacement of cement with the Type B fly ashes produced much higher temperatures than in similar mixes containing the Type A fly ashes. The Type A fly ashes significantly decreased the temperature rise, whereas the Type B fly ashes did not cause a significant decrease in the peak mortar temperature rise as compared to the control containing no fly ash. The measured peak temperature rise for all combinations of the two Type B fly ashes, three cement types, and three replacement rates ranged from a decrease of 10.7°F to an increase of 1.9°F as compared to the control mix. There was no significant decrease in the peak temperature rise as the percentage of Type B fly ash was increased from 20 to 35 percent by volume.

Unlike the Type A fly ashes, the two Type B fly ashes did not produce similar temperature rises in mortar when used with different cements. However, the greatest difference between similar mortar mixes containing fly ashes C and D was only 7.3°F , regardless of cement type and percent replacement.

6.4.2 Time to Peak Temperature. Under adiabatic conditions the time required to reach the peak temperature does not have an effect on the peak temperature because no heat is lost. In concrete members when heat loss is significant, the time to

MAXIMUM TEMPERATURE RISE

.467 W/(C+FA) RATIO, TYPE I-II CEMENT

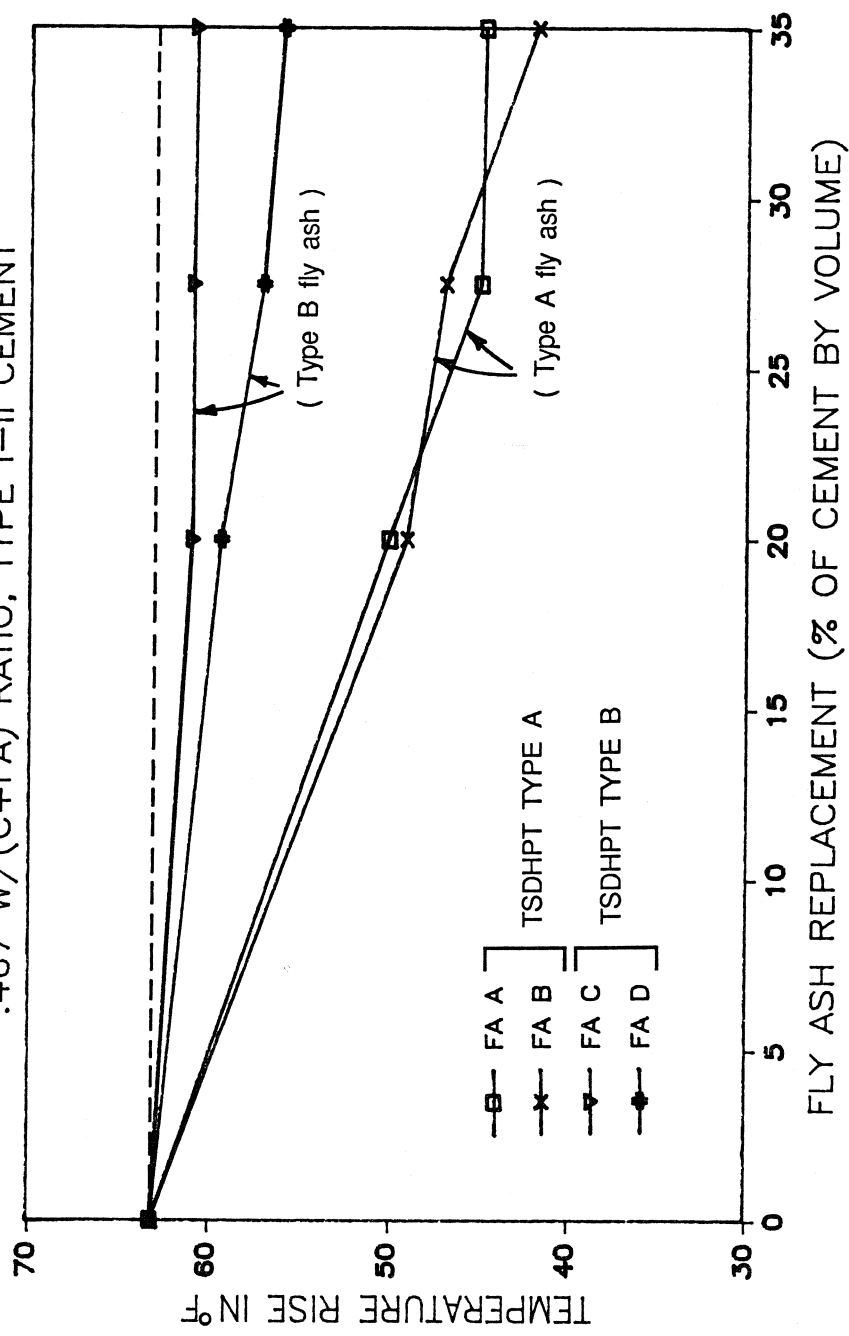

Figure 6.1 Maximum temperature rise in mortar vs. percent replacement of Type I-II cement with fly ash.

MAXIMUM TEMPERATURE RISE

.467 W/(C+FA) RATIO, TYPE I CEMENT

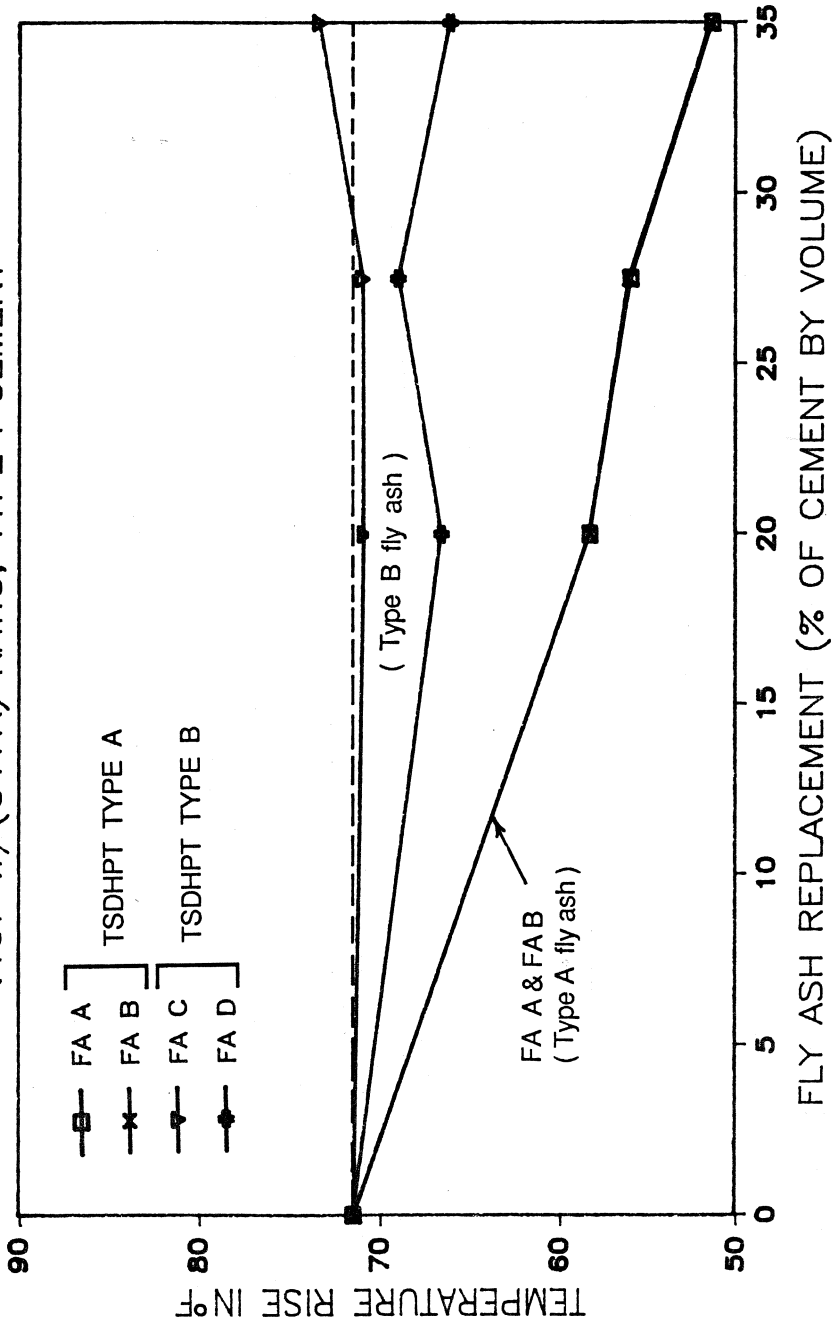

Figure 6.2 Maximum temperature rise in mortar vs. percent replacement of Type I cement with fly ash.

MAXIMUM TEMPERATURE RISE
 .467 W/(C+FA) RATIO, TYPE III CEMENT

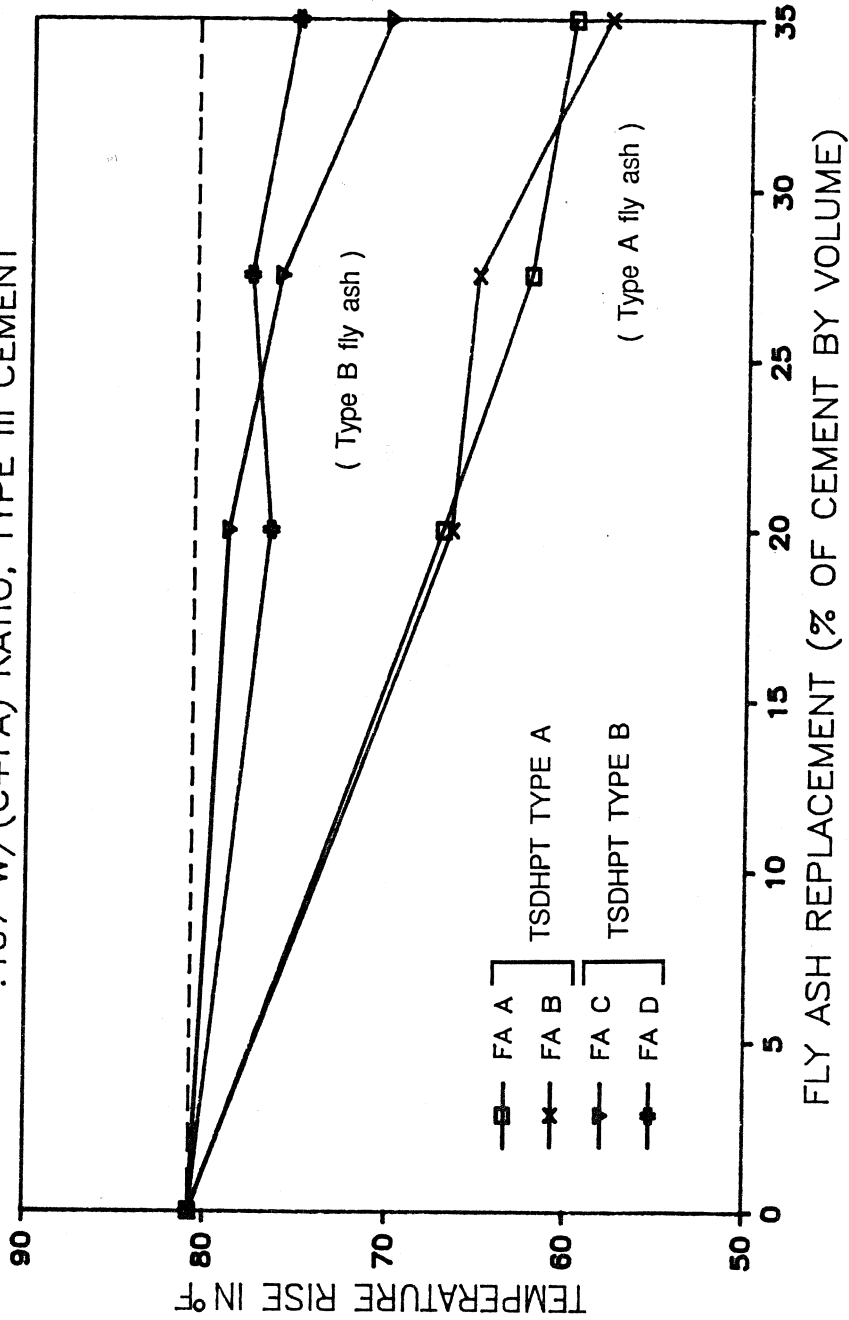

Figure 6.3 Maximum temperature rise in mortar vs. percent replacement of Type III cement with fly ash.

peak influences the peak temperature because a longer time to peak allows more heat to dissipate. The longer time to peak results in a lower internal temperature rise in concrete.

The time to reach 95 percent of the peak temperature is dependent on the cement type and the fly ash used. Type III cement produced the earliest peak time, followed by Type I and Type I-II cement respectively. For the slower reacting Type I-II and Type I cements, the time to peak associated with the addition of Type B fly ash is greater than the time to peak associated with the addition of Type A fly ash as shown in Figures 6.4 and 6.5. Figure 6.6 shows that with the faster reacting Type III cement, the difference in the effect of fly ash type on the time to peak is not as clear as with the slower reacting Type I, and Type I-II cements.

Two general trends are apparent:

- 1) The Type A fly ash mixes peak earlier than similar Type B fly ash mixes. Because the time to peak for the Type A fly ash mixes is similar to that of the control mixes, it appears that the slight time lag associated with the addition of Type A fly ash is due to the replacement of cement with a fairly unreactive material.
- 2) The time to peak increases with the percent replacement of cement with Type B fly ash regardless of cement type. The time to peak is not significantly changed with the replacement of cement by a Type A fly ash. This is clearly illustrated in Figures 6.4 to 6.6 which show the time to 95 percent of the maximum temperature rise.

The longer time to peak for Type B fly ash mixes may indicate that, although the peak temperature was not significantly decreased under nearly adiabatic conditions, under conditions where the rate of heat loss is significant, the longer time to peak may result in a lower temperature rise in concrete in service. That is because as the time to the peak temperature increases, there is more time for heat to dissipate.

6.5 Strength

The strength gain of mortar cubes tested in this study tended to agree with the research findings reported in Chapter 3. All of the strength tests conducted in this study were based on a constant $W/(C+FA)$ ratio without any water reduction to offset the increased flow associated with the replacement of cement with fly ash.

TIME TO 95% OF PEAK TEMPERATURE RISE

.467 W/(C+FA) RATIO, TYPE I-II CEMENT

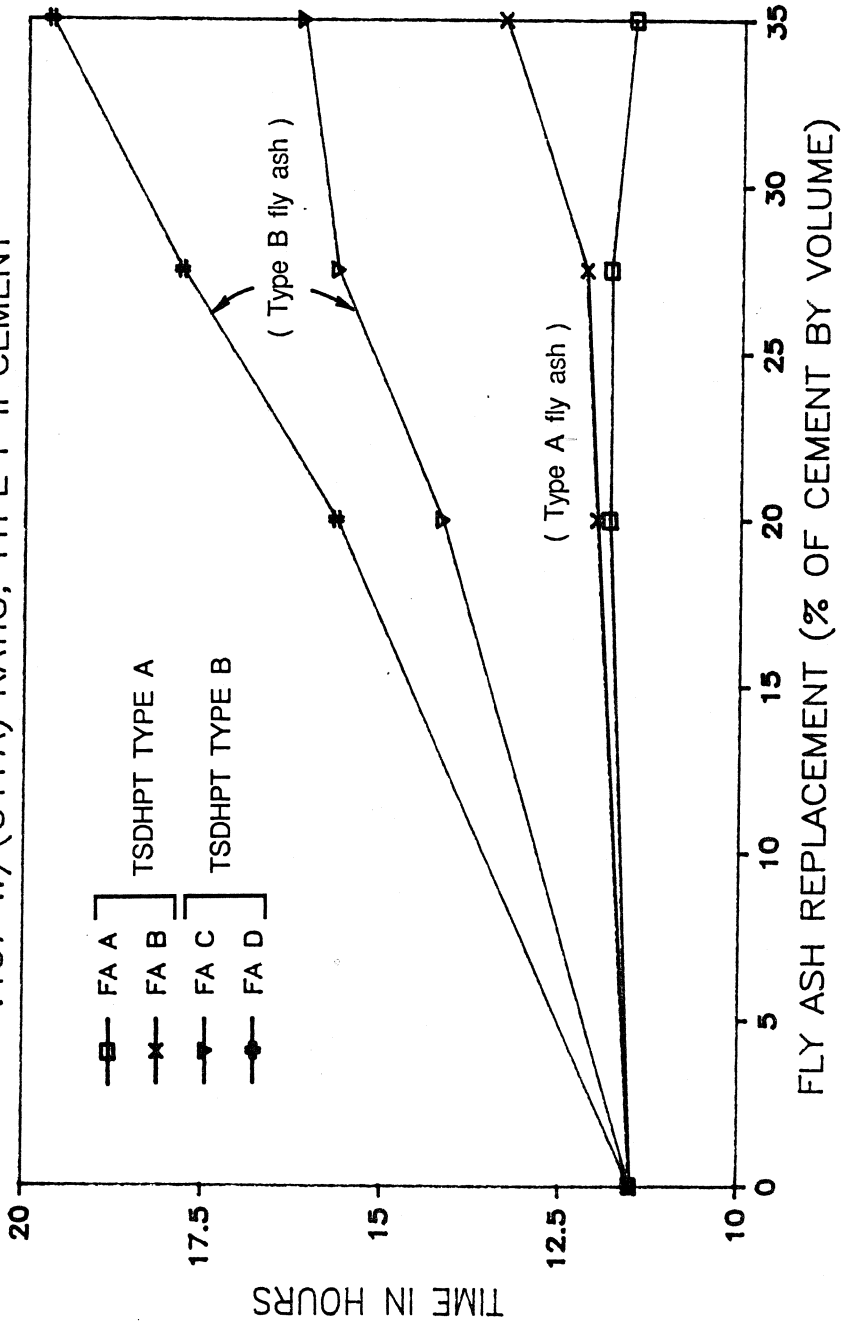

Figure 6.4 Time to 95% of the peak temperature rise in mortar vs. percent replacement of Type I-II cement.

TIME TO 95% OF PEAK TEMPERATURE RISE

.467 W/(C+FA) RATIO, TYPE I CEMENT

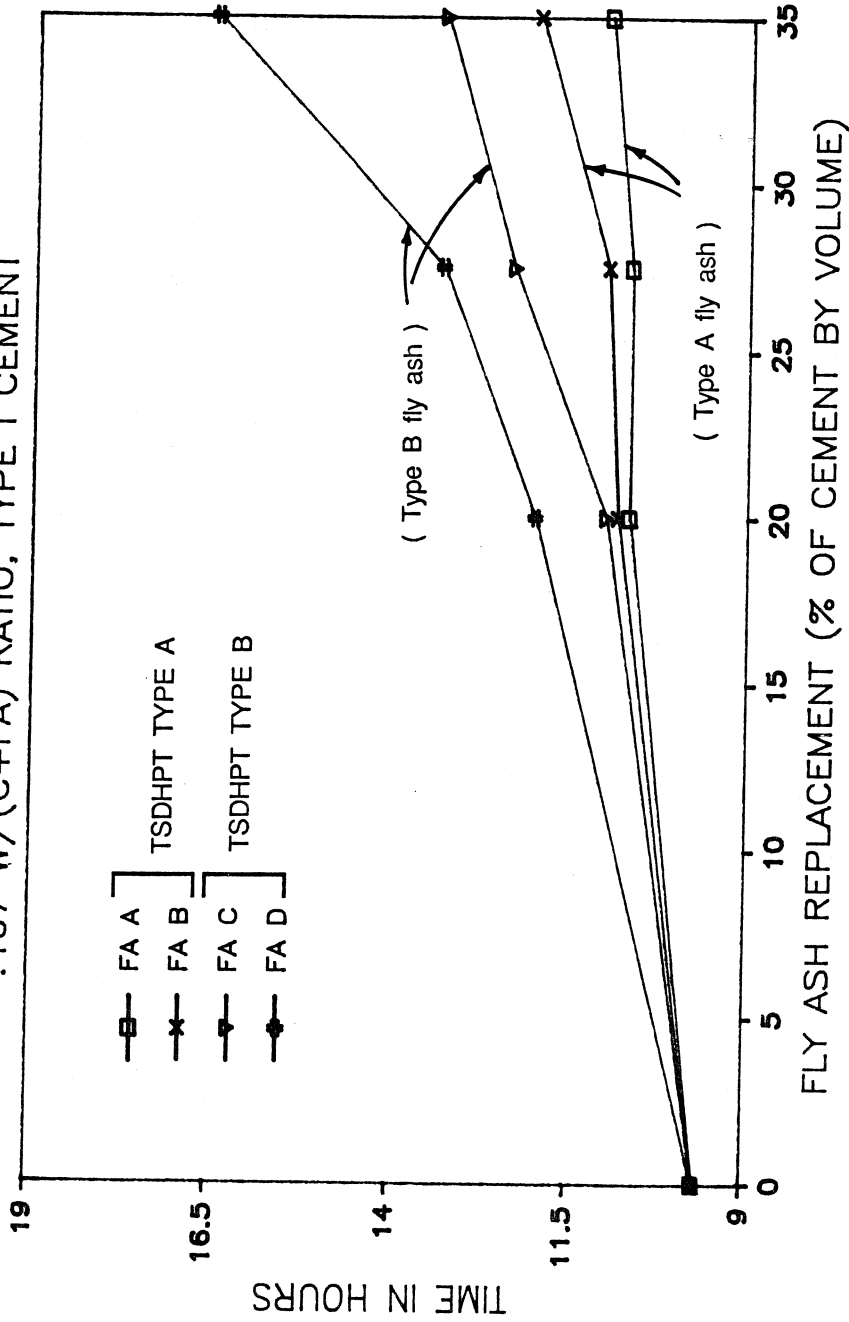

Figure 6.5 Time to 95% of the peak temperature rise in mortar vs. percent replacement of Type I cement.

TIME TO 95% OF PEAK TEMPERATURE RISE
 .467 W/(C+FA) RATIO, TYPE III CEMENT

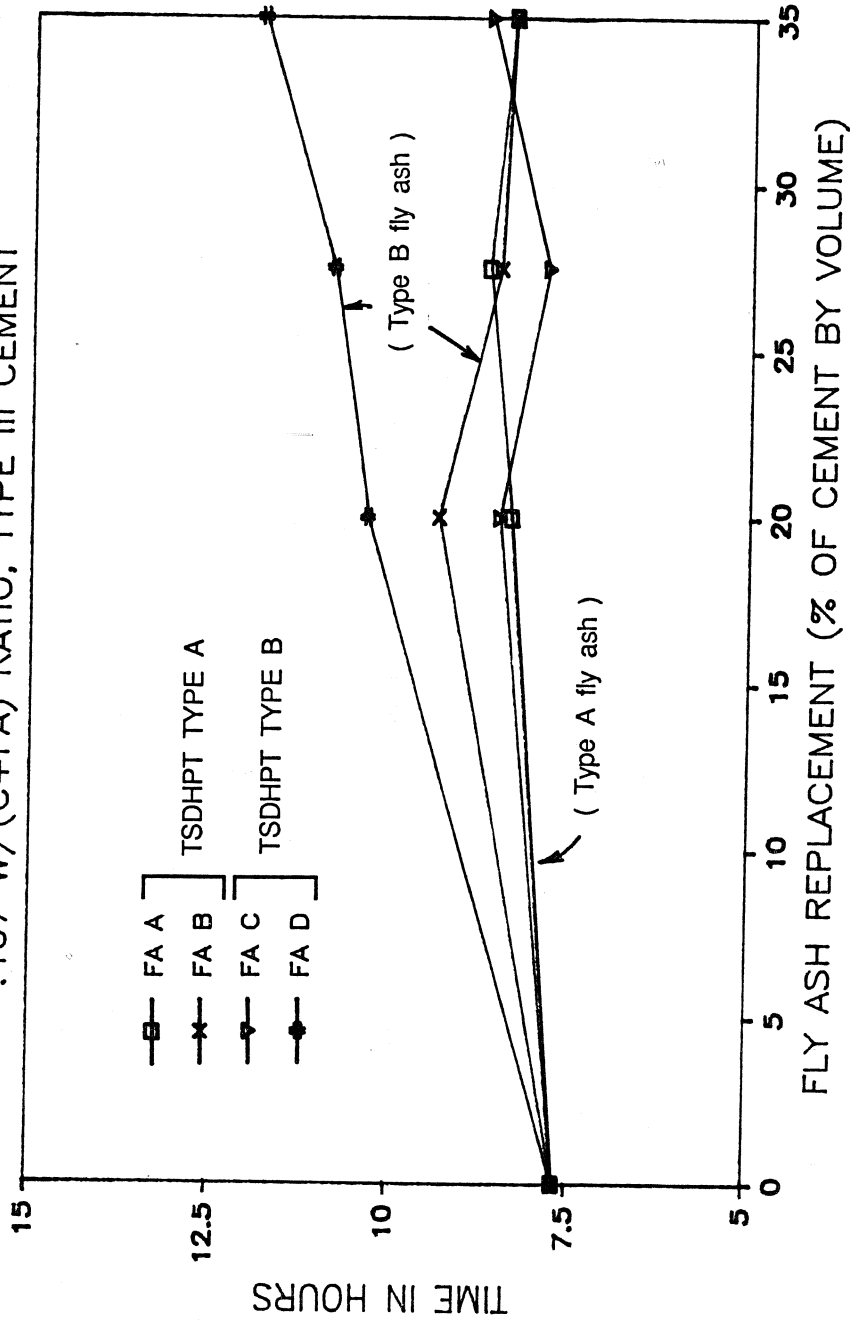

Figure 6.6 Time to 95% of the peak temperature rise in mortar vs. percent replacement of Type III cement.

For mixes containing Type III cement and fly ash, the compressive strength was less than that of the control mix at 28 days regardless of the fly ash type or percent replacement. Fly ash mixes showed a higher rate of strength gain than the control mixes containing no fly ash from 7 to 28 days as shown in Figure 6.7. For ages of 7 and 28 days, the fly ash / control strength ratio for Type III cement mortar mixes increased from 0.87 to 0.94 for 35 percent Type B fly ash (FA D) and from 0.74 to 0.86 for 35 percent Type A fly ash (FA A).

For mixes containing Type I cement, the 7 day compressive strengths for all mixes containing fly ash were less than the control mix. At 28 days, the strength of mortars containing Type B fly ash exceeded the control strength, whereas mortars containing Type A fly ash did not. Figure 6.8 shows that the Type A fly ash mortars did, however, have a higher rate of strength gain from 7 to 28 days than the control. For example, as the mortar age increased from 7 to 28 days, the fly ash / control strength ratio for Type I cement mortar with 35 percent Type A fly ash (FA A) increased from 0.68 to 0.85.

Type I-II cement mortar containing Type B fly ash produced greater strengths at 7 days than the control mix containing no fly ash, except for 20 percent FA D. Similar to the Type I and Type III cement mortars, the Type I-II cement mortars with Type A fly ash produced strengths less than the control strength at 28 days, but exhibited a higher rate of strength gain from 7 to 28 days. (Figure 6.9)

It is important to note that the strength results for Type I- II cement mortars containing fly ash clearly show that each fly ash type has its own optimum percent of cement replacement. Figures 5.44 and 5.45 show that the strength of mortar with FA D appears to have an optimum replacement percentage of approximately 27.5 percent for all cement types and mortar test ages. The mortar strengths with FA C show an opposite trend with lower strengths for 27.5 percent replacement than for 20 and 35 percent. FA C and FA D are both Type B fly ashes. The strength decreased with increasing percentage of Type A fly ash. Similar optimum replacement percentages for fly ash in mortar with a constant $W/(C+FA)$ ratio have been found. [28]

The effect of the curing temperature on the 24 hour compressive strength is shown in Figure 6.10. As the ambient temperature increases, the compressive strength increases. In addition, the figure shows that the strength of cubes containing Type B fly ash were more temperature dependent than were cubes without fly ash. The effect of curing temperature on cube strength is shown in Figure 6.10 as the ratio of the strength

COMPRESSIVE STRENGTH VS. TIME

TYPE III CEMENT, 35% FLY ASH BY VOLUME

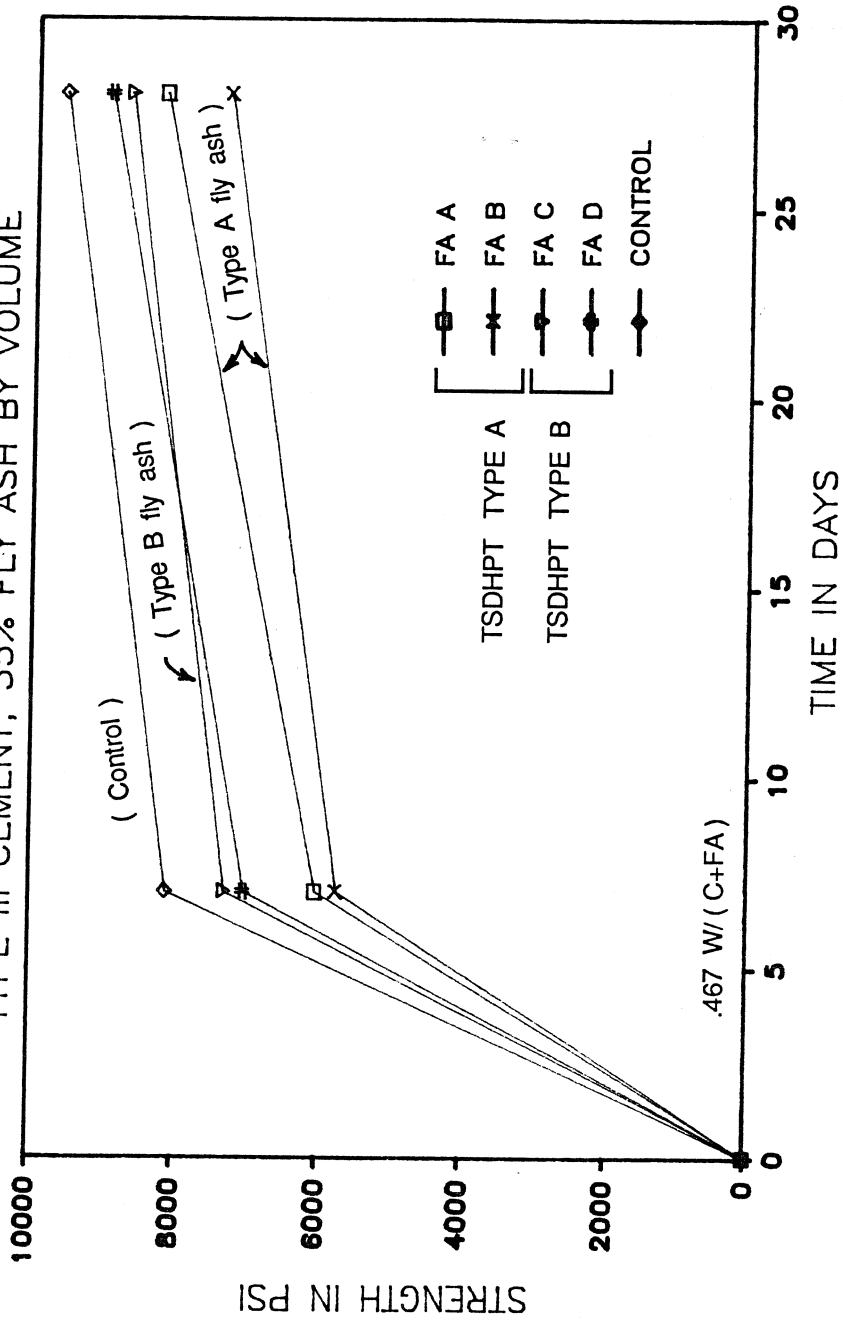

Figure 6.7 Strength development of Type III cement mortars containing fly ash.

COMPRESSIVE STRENGTH VS. TIME

TYPE I CEMENT, 35% FLY ASH BY VOLUME

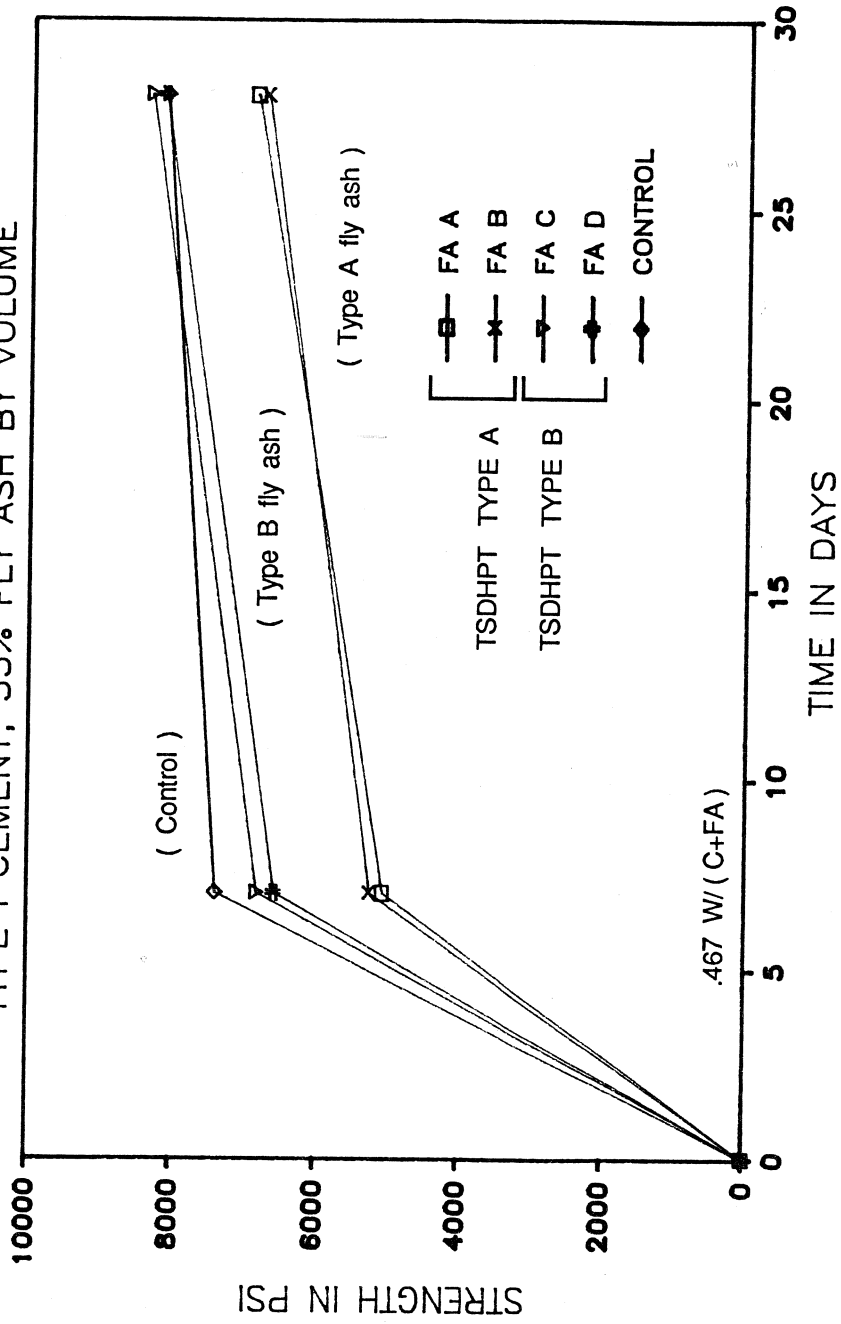

Figure 6.8 Strength development of Type I cement mortars containing fly ash.

COMPRESSIVE STRENGTH VS. TIME

TYPE I-II CEMENT, 35% FLY ASH BY VOLUME

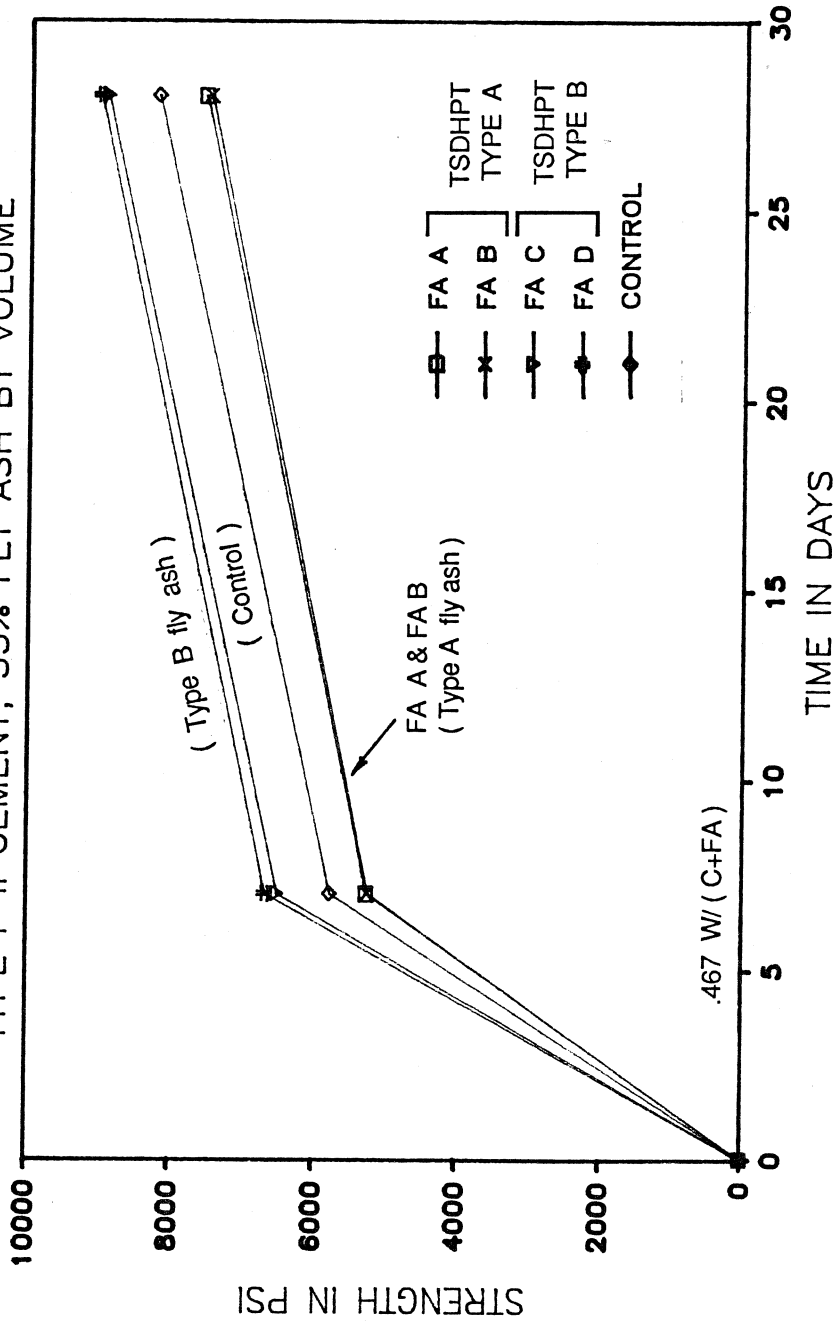

Figure 6.9 Strength development of Type I-II cement mortars containing fly ash.

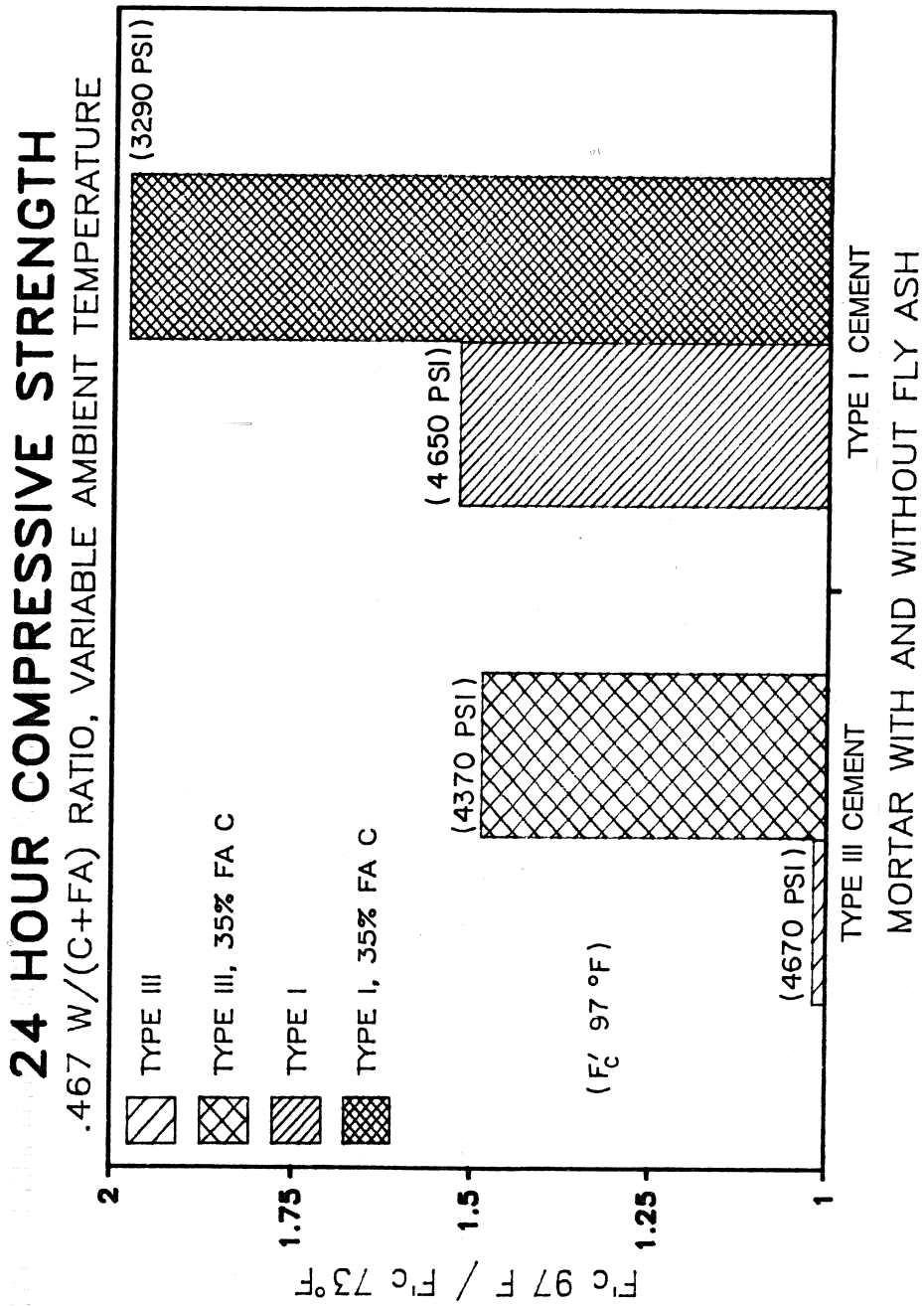

Figure 6.10 Effect of curing temperature on the relative strength of mortar with or without Type B fly ash.

at 97°F to the strength at 73°F. Although the mix containing Type I cement and 35 percent Type B fly ash (FA C) showed the greatest strength gain with the increase in curing temperature, it still had the lowest strength at both temperatures. All four mixes were batched with the same $W/(C+FA)$ ratio.

In mass or hot weather concreting applications a substantial increase in early strength may result for concrete containing a low heat cement or fly ash. The ultimate strength of fly ash concrete generally increases with the curing temperature, in the range of hot weather conditions, whereas the ultimate strength of plain concrete decreases.

6.6 Flow

The replacement of cement with fly ash increased the flow of mortar. The amount of the increase in flow is dependent on the flow of the control mortar which contains no fly ash. A similar trend occurs for the slump of concrete containing water reducers. The increase in slump with the addition of a water reducer is greatest for a low slump base mix.

Flow tests were conducted on Type I and Type III cement mortars. Those cements did not differ greatly in chemical composition but the Type III was ground much finer. Due to the increased surface area associated with the finer particles, the flow of the control mix was only 86 percent for a Type III cement mortar compared to a flow of 127 percent for a Type I cement mortar having the same water to cement ratio.

From Figures 5.50 and 5.51 it can be seen that fly ash increases the flow of mortar. One of the Type A fly ashes (FA A) did, however, have an insignificant affect on the flow. One possible explanation for that lack of flow increase is the high percentage of fine particles in FA A, as compared to the other Type A fly ash (FA B), caused a high water demand. It is also important to note that an increase in flow was not always produced by an increase in fly ash content.

CHAPTER 7

DISCUSSION OF TEST RESULTS FOR MIXES CONTAINING CHEMICAL ADMIXTURE

7.1 Introduction

In this chapter the experimental test results for mortar mixes containing chemical admixture are discussed. To avoid confusion resulting from the large number of variables investigated in this study, the effect of the addition of chemical admixture on the temperature rise, strength, and flow of mortar is discussed alone in this chapter.

This report is the first in a more comprehensive study. The results presented in this study on the effect of the addition of chemical admixture on the temperature rise in concrete are not conclusive due to the limited amount of test data. A more thorough investigation needs to be conducted to verify the results in this study pertaining to the addition of chemical admixture.

7.2 The Effect of Chemical Admixture on the Temperature Rise in Mortar

7.2.1 Peak Temperature. The addition of a retarder or a superplasticizer to any of the mortar mixes without fly ash did not cause a significant change in the peak temperature as shown in Figures 7.1 and 7.2. That is somewhat surprising because the steeper slopes of the temperature rise curves with time shown in Figures 5.37 to 5.41 for the mixes with either of the two chemical admixtures indicate a more rapid rate of heat generation than for the control mixes after the dormant period. The greatest increase in temperature for mixes containing no fly ash associated with the addition of chemical admixture over that for a similar mix without chemical admixture addition was only 3.9°F.

The difference in the peak temperatures for mixes containing no fly ash associated with the dosage rate of retarder or superplasticizer is negligible for the range of dosages tested. In this study, some of the superplasticizer dosages used in the mortar mixes are slightly lower than the manufacturer recommended dosages for concrete. Dosage rates are typically stated in ounces per hundred weight of cement. However, except for batches containing Type III cement, the upper end of the range of recommended dosages for concrete caused the mortar to segregate.

EFFECT OF RETARDER ON TEMPERATURE RISE

.467 W/C RATIO, LIGNOSULFATE BASED RETARDER

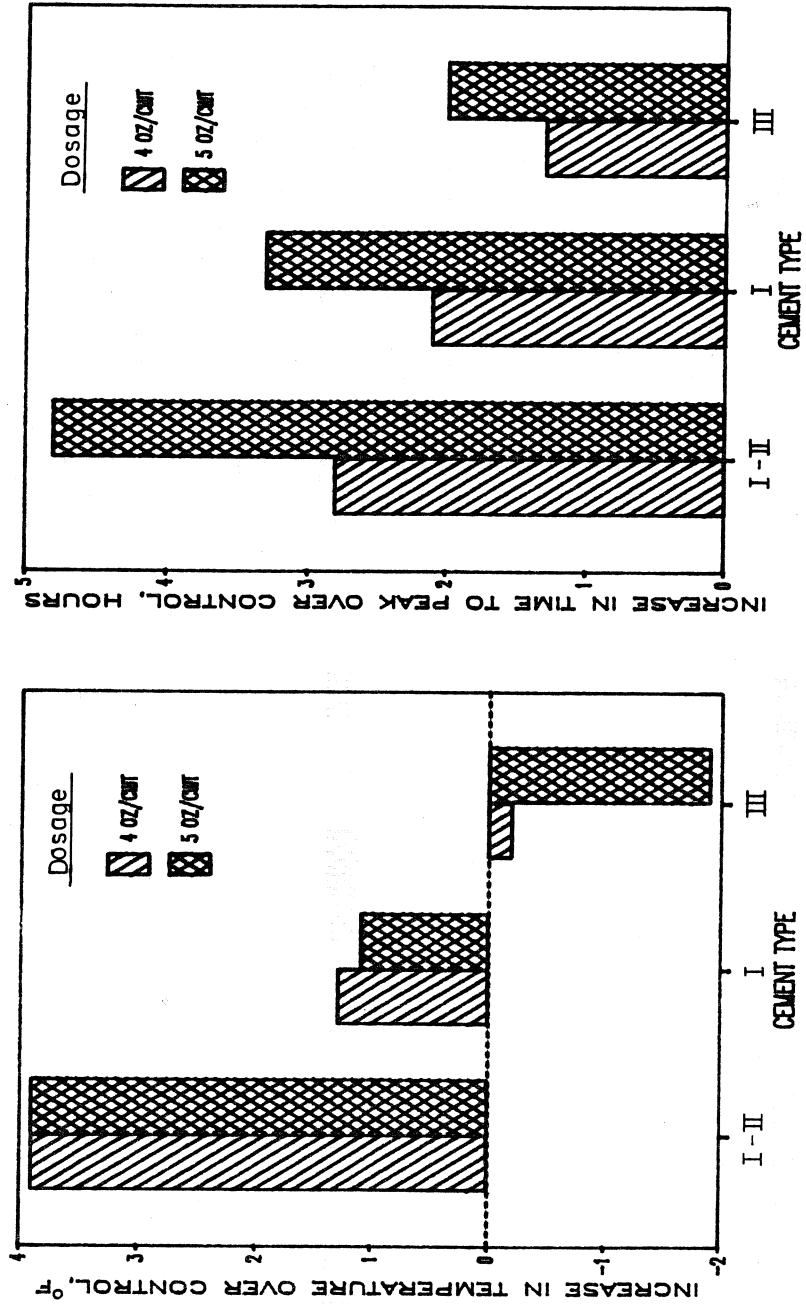

Figure 7.1 Effect of a lignosulfate based retarder on the temperature rise and the time to the peak temperature in mortar containing no fly ash.

EFFECT OF SUPERPLASTICIZER ON TEMP. RISE

.467 W/C RATIO, NAPHTHALENE BASED SUPER.

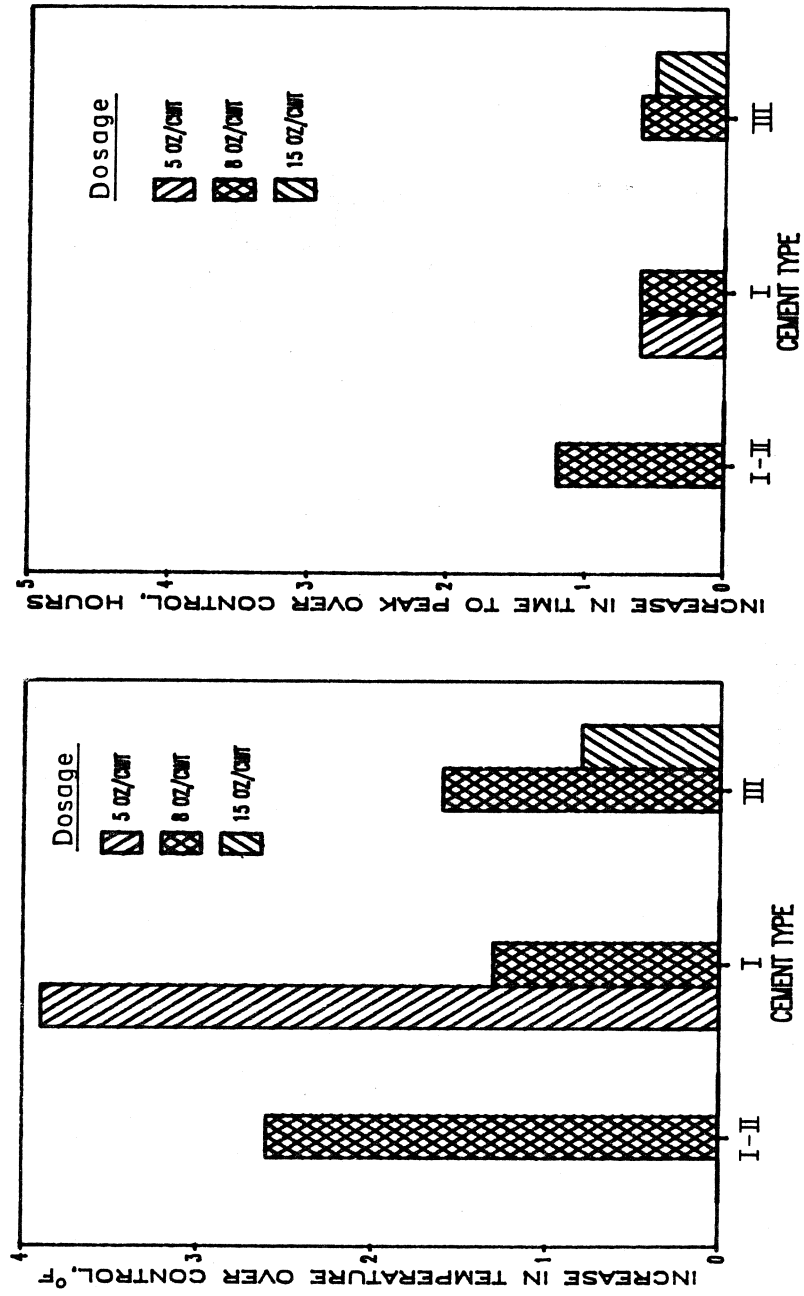

Figure 7.2 Effect of a naphthalene based superplasticizer on the temperature rise and the time to the peak temperature in mortar containing no fly ash.

Figures 7.3 to 7.6 show that the addition of the superplasticizer did not cause a significant increase in the peak temperature in mixes containing fly ash as was the case in mixes containing no fly ash. The addition of the superplasticizer to mortar mixes containing Type I or Type III cement, and Type A or Type B fly ash did not increase the peak temperature by more than 1.4° F as compared to similar mixes containing fly ash and no superplasticizer.

7.2.2 Time to Peak Temperature. Although the addition of a retarder did not produce much change in the peak temperature, it did significantly alter the time to reach the peak temperature. Addition of a retarder increased the time to the peak temperature as shown in Figure 7.1. The range of that increase for the three cement types, with no fly ash, and a retarder dosage of 4 to 5 oz/cwt was from 1.3 to 4.8 hours. The temperature rise curves corresponding to mixes with retarder addition are shaped similarly to the curves without admixtures. The shapes are similar but the retarder delays the curve by 1 to 5 hours which suggests an increased dormant period.

Figure 7.2 indicates that, unlike the addition of the retarder, the addition of superplasticizer to mixes without fly ash did not significantly increase the time to peak. That is because the superplasticizer contained no set retarders. The addition of superplasticizer increased the rate of hydration. That increased rate of hydration can be seen on the temperature rise curves in Figures 5.37 to 5.41. After an extended dormant period, the slope of the temperature rise curves for the mixes with superplasticizer are greater than for the mixes with or without retarder. That increased rate of hydration is most likely a result of the dispersion of cement due to the addition of the superplasticizer.

The addition of superplasticizer had a different effect on the mortar mixes which contained fly ash. A dosage of 8 oz/cwt of Type III cement with 27.5 percent fly ash by volume showed an increase in time to peak of 2.5 hours for a Type A fly ash mix and 2.2 hours for a Type B fly ash mix. For a similar mix containing Type I cement and superplasticizer, a time increase of 4.5 hours was recorded for a Type A fly ash mix opposed to no increase for a Type B fly ash mix.

Thus, the general conclusion from these tests on the effect of the addition of the superplasticizer on the time to the peak temperature is that mixes containing fly ash and a superplasticizer take longer to peak than mixes with fly ash and no superplasticizer.

FLY ASH AND SUPERPLASTICIZER

.467 W/(C+FA) RATIO, TYPE I CEMENT

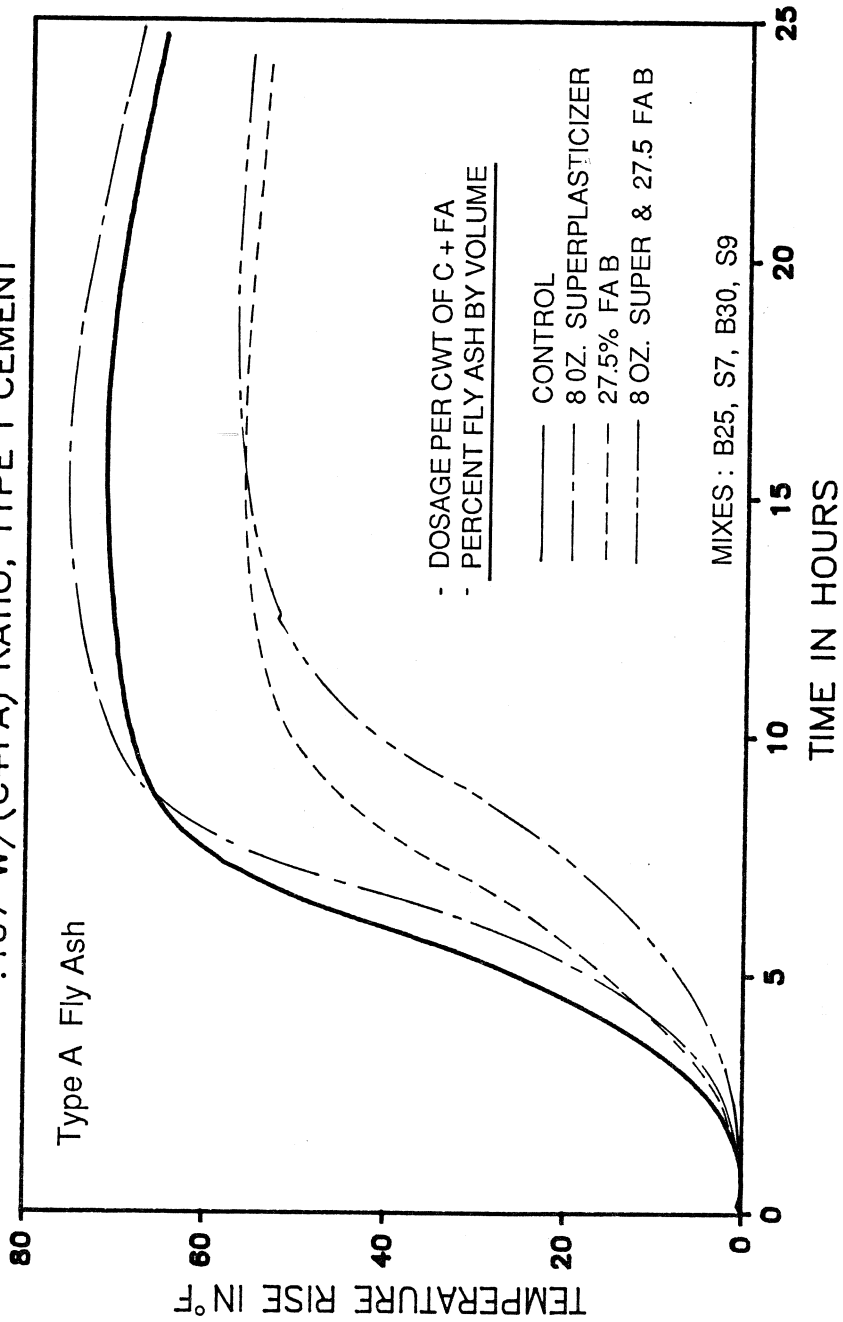

Figure 7.3 Effect of a superplasticizer on the temperature rise in Type I cement mortar with or without Type A fly ash.

FLY ASH AND SUPERPLASTICIZER

.467 W/(C+FA) RATIO, TYPE I CEMENT

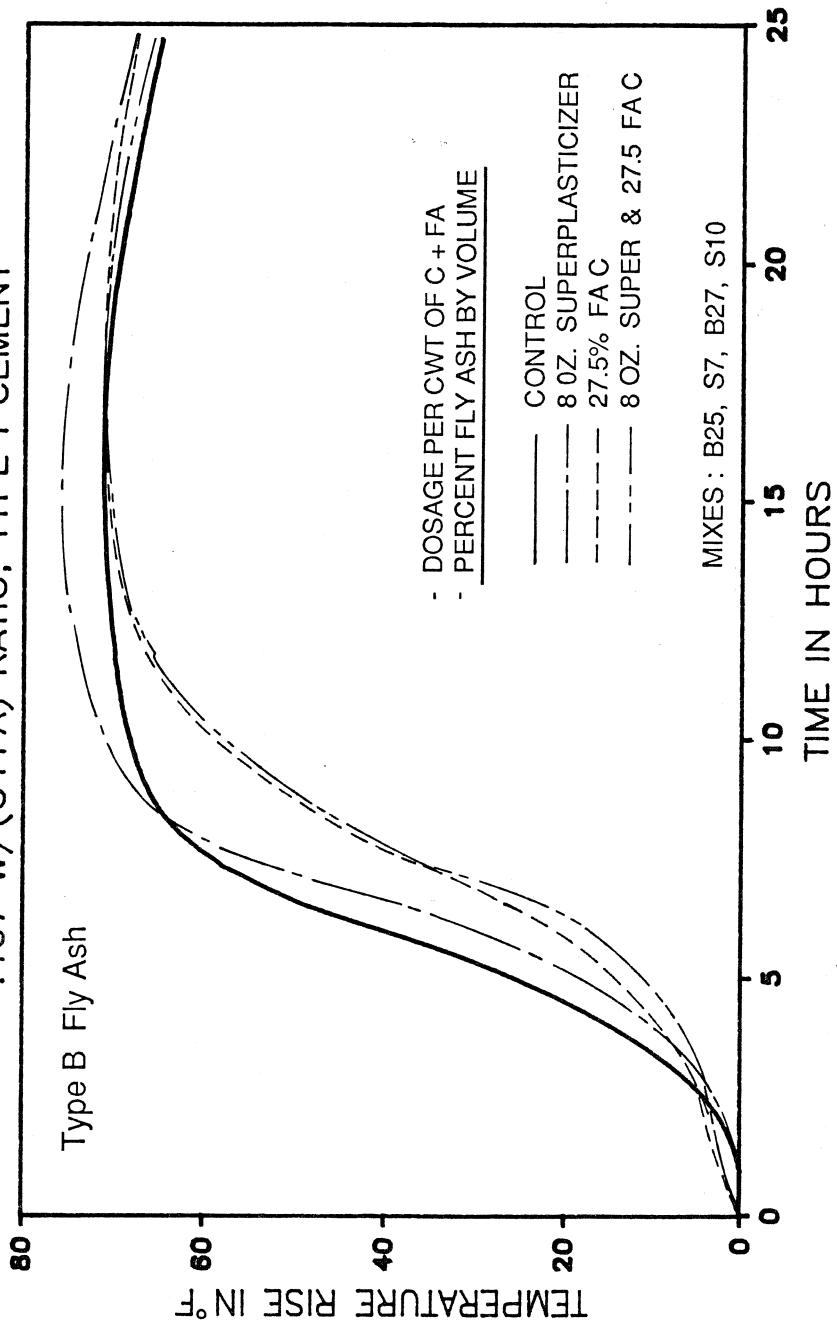

Figure 7.4 Effect of a superplasticizer on the temperature rise in Type I cement mortar with or without Type B fly ash.

FLY ASH AND SUPERPLASTICIZER

.467 W/(C+FA) RATIO, TYPE III CEMENT

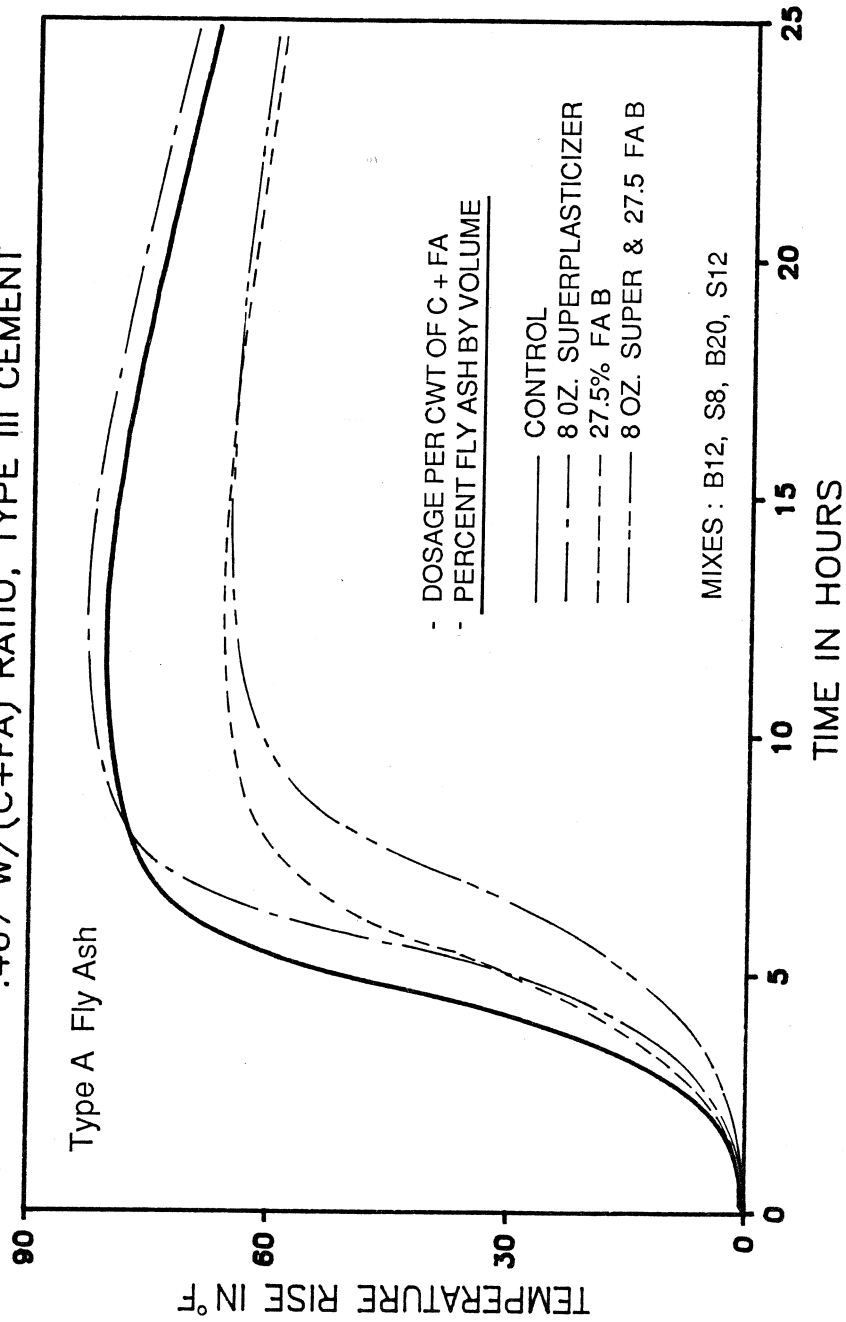

Figure 7.5 Effect of a superplasticizer on the temperature rise in Type III cement mortar with or without Type A fly ash.

FLY ASH AND SUPERPLASTICIZER

.467 W/(C+FA) RATIO, TYPE III CEMENT

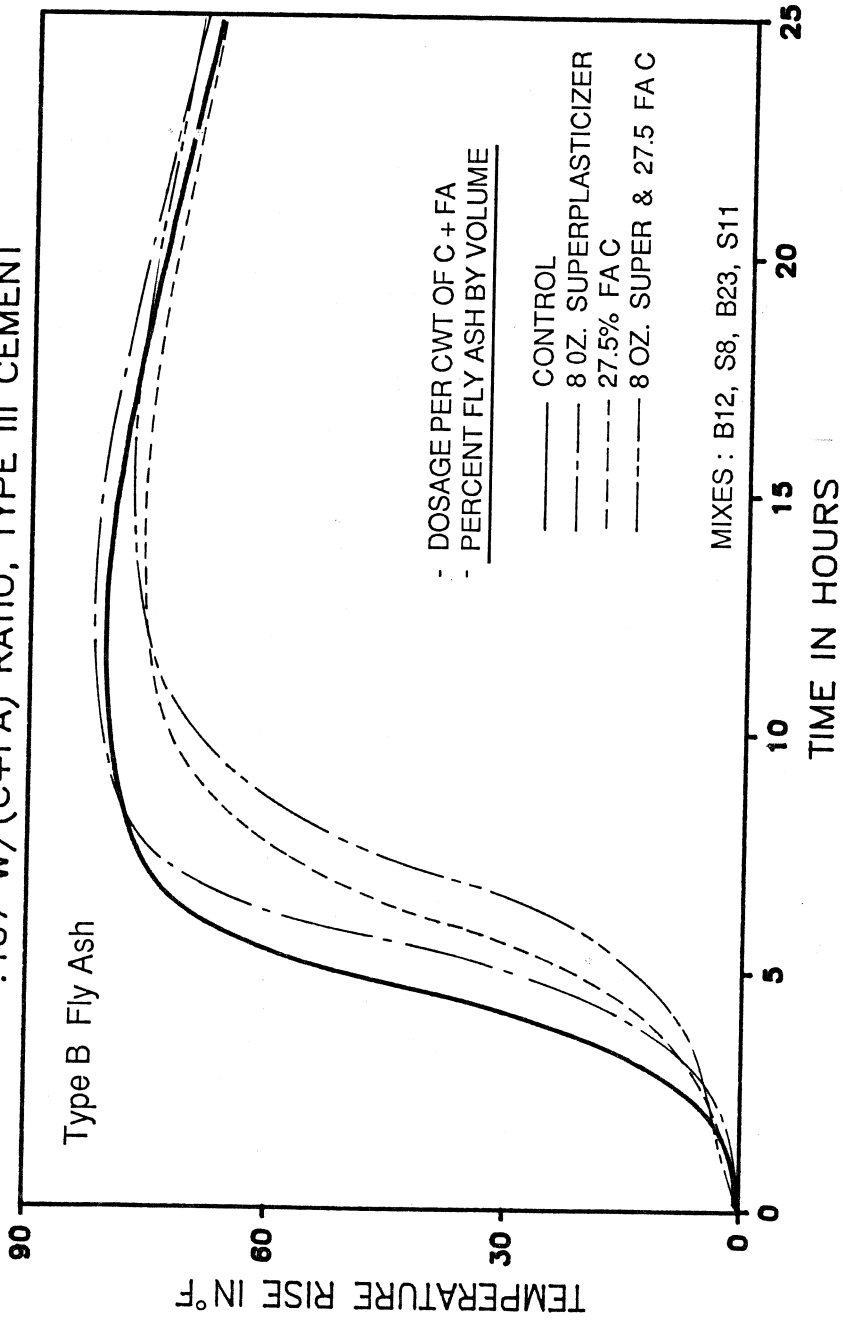

Figure 7.6 Effect of a superplasticizer on the temperature rise in Type III cement mortar with or without Type B fly ash.

7.3 Strength

Figure 7.7 shows that for all three cement types tested, the addition of the retarder reduced the 28 day compressive strength of mortar containing no fly ash. The addition of the superplasticizer to mortar containing no fly ash caused less than a 5 percent change in strength at 28 days compared to a control mix containing no admixtures for all three cement types tested. A significant loss in 28 day strength was observed with the addition of the superplasticizer to mortar containing Type A and Type B fly ash, and Type I and Type III cement as listed in Tables B.6 and B.7 in Appendix B. The loss of strength with the addition of the superplasticizer is surprising because it is generally agreed that chemical dispersants allow for a greater degree of hydration and therefore a greater strength. The loss of strength with chemical admixture addition may be due to the increased bleeding which may reduce the strength of the cube's top surface. That strength loss may also result from additional air content.

7.4 Flow

Figure 7.8 shows a comparison of the flow for mortars containing fly ash and mortars containing a chemical admixture. Both the addition of fly ash and the addition of a chemical admixture produced a greater increase in flow for Type III cement mortars than for the Type I cement mortars.

28 DAY COMPRESSIVE STRENGTH

.467 W/C RATIO

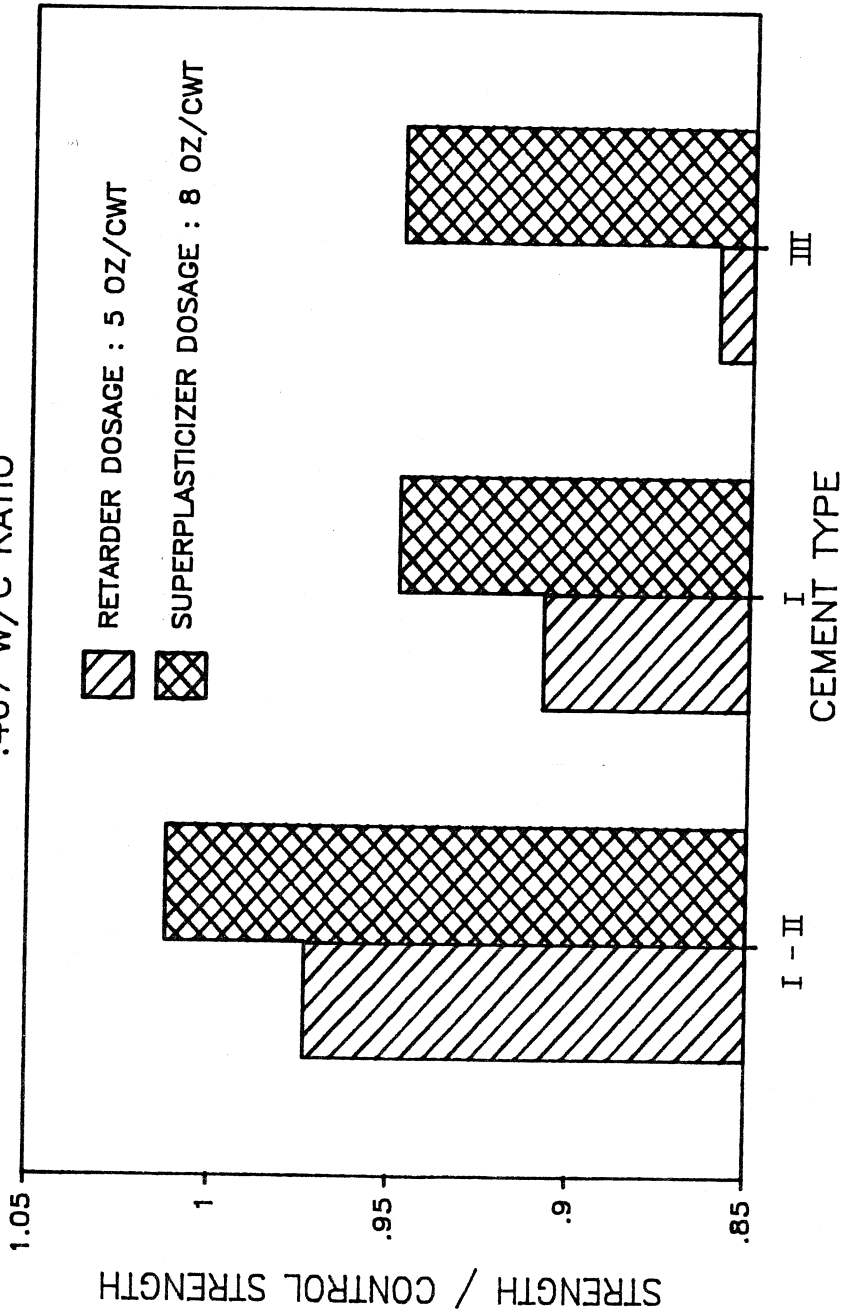

Figure 7.7 Effect of chemical admixture on the 28 day strength of mortar containing no fly ash.

FLOW OF MORTAR
.467 W/(C+FA) RATIO

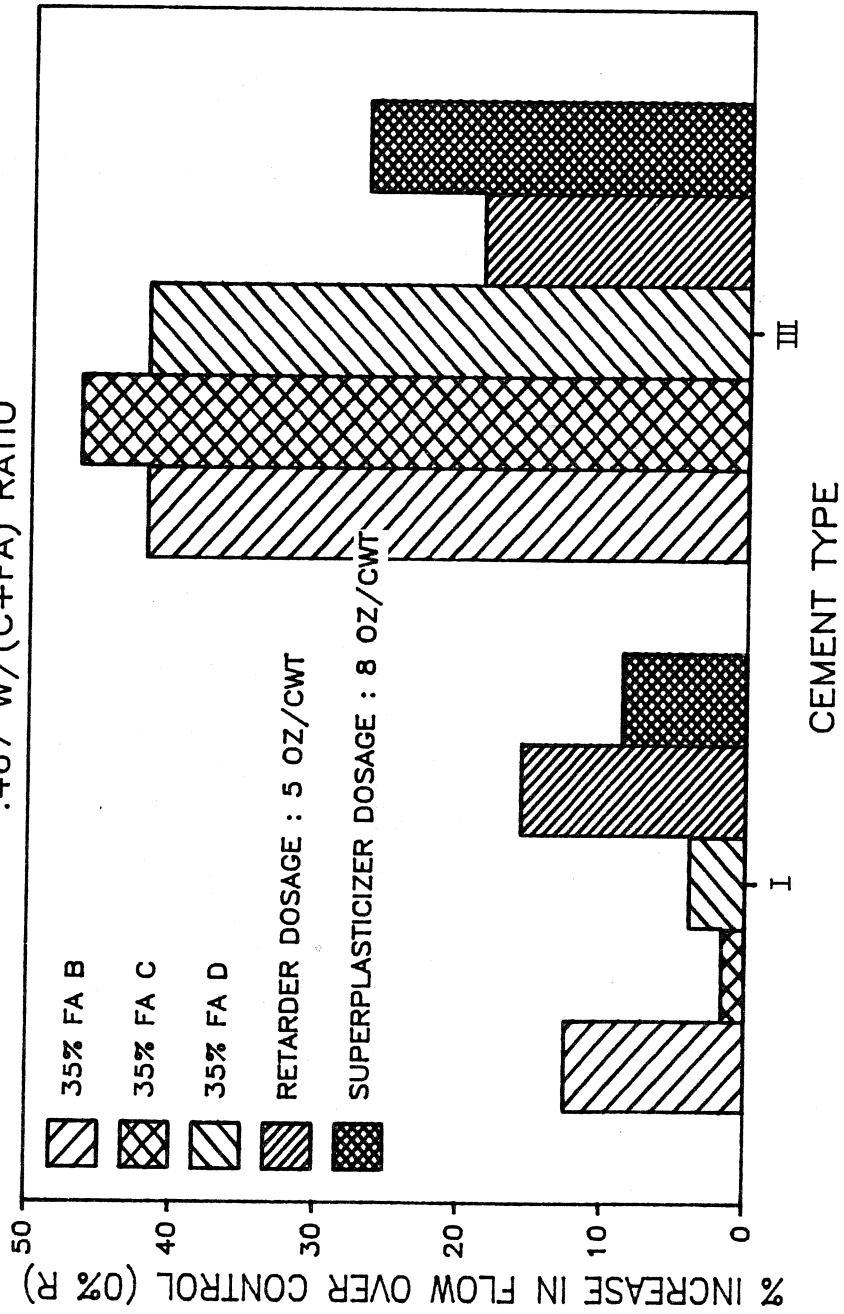

Figure 7.8 Effect of fly ash and chemical admixture on the flow of mortar.

CHAPTER 8

SUMMARY, CONCLUSIONS, AND RECOMMENDATIONS

8.1 Summary

This study was conducted to develop guidelines to aid engineers in designing more durable concrete with respect to temperature effects. The cements, fly ashes, and admixtures used in this study are commercially available throughout Texas and provide a basis for comparison of physical and chemical properties of cements, fly ashes, and admixtures in general.

In this report, the nature of the thermal gradient along a vertical cross section for concrete members with varying dimensions and exposure conditions was examined. The primary purpose of this study was to investigate the effect of fly ash produced in Texas on the temperature rise in concrete. That was accomplished by monitoring the temperature rise in mortar samples. The following materials and proportions were investigated:

- 1) Cement Type
 - a) Type I
 - b) Type I-II
 - c) Type III
- 2) Fly Ash Type
 - a) Type A
 - b) Type B
- 3) Percent Replacement of Cement By Volume
 - a) 0%
 - b) 20%
 - c) 27.5%
 - d) 35%

The effect of the addition of two chemical admixtures on the temperature rise was also examined. Those admixtures were a water reducer/retarder and a superplasticizer.

Strength and flow tests were conducted on all mortar samples. Those tests provide a basis for comparison between mixes with or without fly ash based on the

properties of strength and placeability, which generally are the controlling criteria for concrete mix design.

8.2 Conclusions

8.2.1 Temperature Tests. The purpose of this report is to aid engineers in designing more durable concrete by providing guidelines which will reduce the tendency for thermal cracking. The conclusions of this study pertaining to internal concrete temperature are:

- 1) The thermal gradient along a vertical cross section resulting from the heat developed during the hydration of cement does not vary linearly from the mid-depth temperature to the surface temperature. Most of the temperature drop occurs near the exposed concrete surface. As a result, current guidelines assuming a linear distribution are unconservative for estimating the thermal stresses in concrete resulting from the internal heat of hydration.
- 2) The two Type A fly ashes in this study did significantly reduce the temperature rise in mortar for all cements tested. For all materials used, the higher the cement replacement with Type A fly ash, the lower the peak temperature rise. Cement replacement with Type B fly ash did not significantly reduce the peak temperature. Further, no significant decrease was generally noticed as the percentage of Type B fly ash was increased from 20 to 35 percent by volume.
- 3) The time to the peak temperature under nearly adiabatic conditions for mortar containing Type A fly ash was nearly the same as the control mix containing no fly ash. The time to the peak temperature was longer than the control mix for the Type B fly ash mixes. Unlike the Type A fly ashes, the time to the peak temperature increased with the content of Type B fly ash. That indicates that reductions in the temperature rise within concrete may be realized using higher percentages of Type B fly ashes if the concrete loses heat to the environment at early ages. The longer time to peak allows more heat to dissipate under nonadiabatic conditions.
- 4) The addition of either the retarder or the superplasticizer used in this study did not cause a substantial change in the peak temperature rise for all cements used. Regardless of cement type, the superplasticizer also did not have a significant effect on the peak temperature rise of mixes containing either type of fly ash.

- 5) Under nearly adiabatic conditions, the addition of a retarder to mortar containing no fly ash increased the time to peak, whereas the addition of a superplasticizer did not. Both chemical admixtures produced a prolonged dormant period followed by an increased rate of hydration. Thus, in a nonadiabatic system, the increase in the rate of hydration produced from the addition of either of the chemical admixtures may increase the temperature rise in concrete.

8.2.2 Strength. The conclusions from the testing of mortar cubes are:

- 1) At ages up to 28 days, the strength of cubes containing Type B fly ash may be greater than the control strengths depending on the cement type, fly ash type, and percent replacement.
- 2) At test ages of 28 days or less, mortar containing 20 to 35 percent Type A fly ash had a lower strength than the control strength for all cements used.
- 3) In all cases, the mixes containing fly ash showed a greater rate of strength gain from 7 to 28 days than the control mix containing no fly ash.
- 4) A greater reduction in strength at ages less than 28 days was observed due to the replacement of cement with fly ash in the high early strength cement mix. Thus, the Type III cement mortars showed a greater strength reduction than Type I cement mortars due to the addition of fly ash.
- 5) The strength of mortar containing fly ash is dependent on the fly ash type and percent replacement. Each individual fly ash has its own optimum replacement percentage for each cement used. This is more significant as the strength of the control mix decreases.
- 6) As the curing temperature is raised from 73 to 97°F, the percent increase in strength at 24 hours is greater for mortar containing Type B fly ash than for a similar control mix containing no fly ash. That is to say that fly ash mortar is more temperature sensitive than control mixes containing Type I or Type III cement and no fly ash.

8.2.3 Flow. The conclusions of the flow tests are:

- 1) In general, the flow of mortar is increased with the replacement of cement by fly ash.
- 2) A greater increase in flow was observed with the replacement of Type III cement with fly ash than with the replacement of Type I cement.

- 3) The flow is not steadily increased within the replacement range of 20 to 35 percent. Such a steady increase in flow with fly ash content is predicted by the ball-bearing analogy for the spherical fly ash particles. The increase in flow in mortar containing fly ash may well be due in part to the fact that fly ash acts as a dispersant.

8.3 Guidelines

Based on the test results presented in this study, the following guidelines for the partial replacement of cement with fly ash to reduce the tendency for thermal cracking in concrete have been developed:

- 1) Regardless of fly ash type, the use of fly ash reduces the tendency for thermal cracking in concrete in nonadiabatic conditions.
- 2) The partial replacement of cement with Type A fly ash results in a reduction in the peak temperature rise in concrete thus reducing the potential for thermal cracking.
- 3) The partial replacement of cement with Type B fly ash does not cause a significant reduction in the peak temperature rise in concrete under nearly adiabatic conditions. However, Type B fly ash produces a longer time to the peak temperature allowing more heat dissipation in concrete in nonadiabatic conditions. As a result, the replacement of cement with Type B fly ash will reduce the tendency for thermal cracking in concrete cast and cured in the field.
- 4) The higher the cement content, the greater the temperature rise in concrete, and thus the greater the potential for thermal cracking.
- 5) Curing concrete by covering the exposed surfaces with damp burlap and plastic may result in a higher internal concrete temperature at mid-depth, but a lower temperature drop between the mid-depth temperature and the covered surface temperature. The lower temperature drop reduces the tendency for thermal cracking.

8.4 Recommendations for Future Research

This report addressed the important question of whether the partial replacement of cement by fly ash in general reduces the temperature rise in concrete. There

is still much more that needs to be investigated on the temperature rise in concrete. Recommended areas for future research are:

- 1) Develop equations or guidelines to predict the thermal gradient in concrete due to hydration.
- 2) Develop a failure theory for concrete subjected to a thermal strain gradient.
- 3) Monitor the rate of heat evolution of fly ash paste under isothermal conditions. This will show how the cement - fly ash system is affected by the system temperature. Also, the measurement of the rate of heat evolution and the total heat evolved will indicate the potential temperature rise under varying thermal conditions (rates of heat loss).
- 4) Examine the effect of superplasticizers on the temperature rise in concrete. Only one of the three superplasticizer formulations was tested in this study.

APPENDIX A
MATERIAL PROPERTIES AND MIX PROPORTIONS

Table A.1 Ready Mixed Concrete Proportions

	Test 1	Test 2	Test 3	Test 4
Design Strength (psi)	5000	5000	6000	5000
Coarse Aggr.: River Gravel, 3/4 in. max (lb/yd ³ at SSD)	1888	1854	1880	1893
Fine Aggr.: River Sand (lb/yd ³ at SSD)	1456	1493	1440	1413
Cement: Type I (lb/yd ³)	474	467	473	517
Water (lb/yd ³)	168	168	107	144
Water Reducer: Lignosulfate Based (oz/cwt)	0.0	0.0	0.0	3.2
Retarder: Lignosulfate Based (oz/cwt)	3.8	3.6	3.3	0.0
Air Entraining Agent: Saponified Wood Resin (oz/cwt)	0.6	0.0	0.9	0.0

Table A.2 Chemical and Physical Properties of Fly Ash A

	Experimental Program Fly Ash A	Specifications Texas SDHPT*	
		Type A	Type B
Si+Al+Fe Oxides (%)	78.48	65	50
Si Oxide (%)	55.54	-	-
Al Oxide (%)	18.61	-	-
Ca Oxide (%)	6.97	**	**
Mg Oxide (%)	0.81	5.0	5.0
Sulfate (%)	0.26	5.0	5.0
Available Alkalies (%)	0.31	1.5	1.5
Loss on Ignition (%)	0.04	3.0	3.0
Moisture Content (%)	0.07	2.0	2.0
Shrinkage (%)	0.007	0.03	0.03
Pozzolanic Activity	97.09	75	75
Specific Gravity	2.32	-	-
Blaine Fineness (cm ² /gm)	2520	-	-
Percent Retained on #325 Sieve	13.30	30	30

*Maximum values except for sum of oxides and pozzolanic activity.

**4% maximum variation from previous ten samples.

Table A.3 Chemical and Physical Properties of Fly Ash B

	Experimental Program Fly Ash B	Specifications Texas SDHPT*	
		Type A	Type B
Si+Al+Fe Oxides (%)	79.77	65	50
Si Oxide (%)	52.90	-	-
Al Oxide (%)	17.89	-	-
Ca Oxide (%)	9.55	**	**
Mg Oxide (%)	1.66	5.0	5.0
Sulfate (%)	0.90	5.0	5.0
Available Alkalies (%)	0.57	1.5	1.5
Loss on Ignition (%)	0.19	3.0	3.0
Moisture Content (%)	0.03	2.0	2.0
Shrinkage (%)	0.01	0.03	0.03
Pozzolanic Activity	90.90	75	75
Specific Gravity	2.43	-	-
Blaine Fineness (cm ² /gm)	2560	-	-
Percent Retained on #325 Sieve	23.81	30	30

*Maximum values except for sum of oxides and pozzolanic activity.

**4% maximum variation from previous ten samples.

Table A.4 Chemical and Physical Properties of Fly Ash C

	Experimental Program Fly Ash C	Specifications Texas SDHPT*	
		Type A	Type B
Si+Al+Fe Oxides (%)	53.51	65	50
Si Oxide (%)	28.38	-	-
Al Oxide (%)	20.19	-	-
Ca Oxide (%)	33.93	**	**
Mg Oxide (%)	8.41	5.0	5.0
Sulfate (%)	4.45	5.0	5.0
Available Alkalies (%)	1.54	1.5	1.5
Loss on Ignition (%)	0.25	3.0	3.0
Moisture Content (%)	0.02	2.0	2.0
Shrinkage (%)	-0.005	0.03	0.03
Pozzolanic Activity	91.46	75	75
Specific Gravity	2.79	-	-
Blaine Fineness (cm ² /gm)	3510	-	-
Percent Retained on #325 Sieve	10.40	30	30

*Maximum values except for sum of oxides and pozzolanic activity.

**4% maximum variation from previous ten samples.

Table A.5 Chemical and Physical Properties of Fly Ash D

	Experimental Program Fly Ash D	Specifications Texas SDHPT*	
		Type A	Type B
Si+Al+Fe Oxides (%)	59.38	65	50
Si Oxide (%)	32.23	-	-
Al Oxide (%)	22.18	-	-
Ca Oxide (%)	29.86	**	**
Mg Oxide (%)	5.63	5.0	5.0
Sulfate (%)	2.48	5.0	5.0
Available Alkalies (%)	1.67	1.5	1.5
Loss on Ignition (%)	0.03	3.0	3.0
Moisture Content (%)	0.10	2.0	2.0
Shrinkage (%)	-0.007	0.03	0.03
Pozzolanic Activity	91.55	75	75
Specific Gravity	2.70	-	-
Blaine Fineness (cm ² /gm)	4220	-	-
Percent Retained on #325 Sieve	18.90	30	30

*Maximum values except for sum of oxides and pozzolanic activity.

**4% maximum variation from previous ten samples.

Table A.6 Chemical and Physical Properties of Type I Portland Cement

Chemical Composition		Percent
Silicon Dioxide (SiO ₂)		20.3
Aluminum Dioxide (Al ₂ O ₃)		5.9
Ferric Oxide (Fe ₂ O ₃)		3.0
Calcium Oxide (CaO)		64.2
Magnesium Oxide (MgO)		1.1
Sulfur Trioxide (SO ₃)		3.1
Loss on Ignition		1.5
Insoluble Residue		0.18
Free Lime		1.5
Tricalcium Silicate (C ₃ S)		54.0
Tricalcium Aluminate (C ₃ A)		10.6
Alkali Total		0.77

Physical Properties	Gilmore	Vicat
<i>Time of Setting:</i>		
Initial	105 min	-
Final	215 min	-
<i>Specific Surface:</i>		
Blaine	3500 cm ² /gm	
Wagner	1890 cm ² /gm	
<i>Compressive Strength:</i>		
1-day	2080 psi	
3-day	3470 psi	

Table A.7 Chemical and Physical Properties of Type I-II Portland Cement

Chemical Composition		Percent
Silicon Dioxide (SiO ₂)		21.8
Aluminum Dioxide (Al ₂ O ₃)		4.2
Ferric Oxide (Fe ₂ O ₃)		3.2
Calcium Oxide (CaO)		64.7
Magnesium Oxide (MgO)		0.6
Sulfur Trioxide (SO ₃)		2.9
Loss on Ignition		0.9
Insoluble Residue		0.3
Free Lime		0.9
Tricalcium Silicate (C ₃ S)		54.0
Tricalcium Aluminate (C ₃ A)		6.0
Alkali Total		0.63

Physical Properties	Gilmore	Vicat
<i>Time of Setting:</i>		
Initial	125 min	88 min
Final	225 min	201 min
<i>Specific Surface:</i>		
Blaine	3350 cm ² /gm	
Wagner	1880 cm ² /gm	
<i>Compressive Strength:</i>		
1-day	1970 psi	
3-day	3550 psi	

Table A.8 Chemical and Physical Properties of Type III Portland Cement

Chemical Composition		Percent
Silicon Dioxide (SiO ₂)		20.6
Aluminum Dioxide (Al ₂ O ₃)		5.4
Ferric Oxide (Fe ₂ O ₃)		2.6
Calcium Oxide (CaO)		64.4
Magnesium Oxide (MgO)		1.1
Sulfur Trioxide (SO ₃)		3.7
Loss on Ignition		1.6
Insoluble Residue		0.22
Free Lime		1.4
Tricalcium Silicate (C ₃ S)		55.0
Tricalcium Aluminate (C ₃ A)		10.0
Alkali Total		0.75

Physical Properties	Gilmore	Vicat
<i>Time of Setting:</i>		
Initial	100 min	-
Final	195 min	-
<i>Specific Surface:</i>		
Blaine	5990 cm ² /gm	
Wagner	2840 cm ² /gm	
<i>Compressive Strength:</i>		
1-day	3760 psi	
3-day	5100 psi	

Table A.9 Sand A (Colorado River Sand)

Absorption Capacity:	0.6 %
Specific Gravity SSD:	2.6
Fineness Modulus:	2.58

Sieve Analysis

<u>Sieve</u>	<u>Percent Retained</u>
No. 4	0.2
No. 8	3.8
No. 16	26.5
No. 30	53.7
No. 50	77.8
No. 100	96.2

Table A.10 Sand B (Colorado River Sand)

Absorption Capacity:	1.2 %
Specific Gravity SSD:	2.6
Fineness Modulus:	2.78

Sieve Analysis

<u>Sieve</u>	<u>Percent Retained</u>
No. 4	0.1
No. 8	8.5
No. 16	30.0
No. 30	58.1
No. 50	83.4
No. 100	97.8

MORTAR MIXES

Batch Numbering

Sample batch number: B4 27.5D I-II

The batch number describes the mortar mix as follows:

- First letter designates the sand used: A or B
- First number designates chronological order of mixes.
- Second number denotes the percentage of cement replaced by fly ash by volume: 0, 20, 27.5, or 35.
- Second letter denotes fly ash used: A, B, C, or D.
- The final numbers refer to the cement type used: , I-II, or III.

The sample batch number above refers to a mortar mix containing sand B, and 27.5 percent replacement of Type I-II cement by fly ash D. This was the fourth batch mixed with sand B.

Batch Weights

The batch weights are the stock weights. The dry weight of the sand can be calculated given the moisture content (MC) which was determined just prior to batching.

Admixture

The letter next to the admixture dosage denotes the admixture type used. R refers to the addition of the retarder and S refers to the addition of the superplasticizer.

Volume Per Cubic Foot

The volumes per cubic foot are based on the sand at saturated surface dry condition (SSD).

Table A.11 Mix Proportions and Initial Mix Temperatures for Mortars Containing Type I-II Cement

BATCH	MORTAR MIXES										AMBIENT RANGE			
	BATCH WEIGHTS (LBS)					VOLUME PER CUBIC FOOT								
	CEMENT	FLYASH	SAND	WATER	MC W/(C+FA)	ADMIXTURE (MI)	CEMENT	FLYASH	SAND	WATER	AIR	SAMPLE WEIGHT	INITIAL MIX TEMP	
A13 0 1-11	11.75	0	32.31	4.45	0.451	482	172	.000	.542	.256	.03	12.5	87	79-83
A16 0 1-11	11.75	0	32.31	5.57	0.102	485	168	.000	.549	.253	.03	12.5	94	79-85
A17 35A 1-11	7.64	3.08	32.31	5.07	0.102	485	112	.060	.562	.236	.03	12.12	92	79-85
A18 35C 1-11	7.64	3.7	32.31	5.37	0.102	485	110	.059	.554	.246	.03	12.49	92	79-85
A19 0 1-11	11.75	0	32.31	5.1	0.248	484	170	.000	.546	.255	.03	12.5	79	79-84
A20 35A 1-11	7.64	3.08	33.11	4.6	0.248	486	111	.060	.564	.235	.03	12.12	79	79-84
A21 35C 1-11	7.64	3.7	32.31	4.9	0.248	484	111	.060	.551	.248	.03	12.49	80	79-84
A24 35A 1-11	7.64	3.08	33.52	3.27	0.375	382	117	.063	.596	.194	.03	12.29	81.4	69-76
A25 35A 1-11	7.64	3.08	33.52	5.09	0.375	552	107	.058	.547	.257	.03	12.29	80	69-76
A26 0 1-11	11.75	0	33.52	5.68	0.375	554	161	.000	.533	.276	.03	12.29	80.7	69-76
A28 0 1-11	11.69	0	33.16	5.02	0.264	469	168	.000	.559	.244	.03	12.5	81.4	68-73
A29 35A 1-11	7.64	3.08	33.16	4.54	0.264	467	112	.060	.571	.227	.03	12.5	81.4	68-73
A31 0 1-11	11.69	0	32.87	4.15	0.224	384	176	.000	.584	.209	.03	12.24	85.7	71-75
B1 35D 1-11	7.15	3.35	30.93	4.59	0.224	467	111	.060	.585	.235	.03	12.31	83.7	71-75
B2 20D 1-11	8.8	1.92	30.95	4.68	0.233	468	135	.034	.561	.239	.03	12.39	81	68-83
B3 27.5D 1-11	7.98	2.63	30.95	4.63	0.233	469	123	.047	.583	.238	.03	12.35	81	68-83
B4 27.5A 1-11	7.98	2.26	30.95	4.45	0.233	468	124	.047	.568	.231	.03	12.2	81	68-83
B5 20A 1-11	8.8	1.65	30.25	4.33	0.305	466	139	.035	.558	.238	.03	12.29	79.3	69-76
B6 20C 1-11	8.8	1.98	31.17	4.49	0.305	468	135	.034	.561	.240	.03	12.42	80.5	69-76
B7 27.5C 1-11	7.98	2.72	31.17	4.45	0.305	468	123	.047	.562	.239	.03	12.39	81	69-76
B8 35C 1-11	7.15	3.47	31.17	4.41	0.305	468	110	.059	.563	.238	.03	12.35	82.5	69-76
B9 20B 1-11	8.8	1.72	30.85	4.68	0.198	467	136	.034	.564	.236	.03	12.31	79.8	69-75
B10 27.5B 1-11	7.98	2.37	30.85	4.6	0.198	467	124	.047	.567	.233	.03	12.25	80.4	69-75
B11 35B 1-11	7.15	3.02	30.85	4.51	0.198	467	111	.060	.569	.229	.03	12.17	79.2	69-75
B39 0 1-11	11.69	0	32.76	5.2	0.205	468	168	.000	.558	.244	.03	12.5	82.2	70-75
B40 35A 1-11	7.64	3.08	32.97	4.73	0.205	467	112	.060	.571	.227	.03	12.12	81.8	70-75
R1 0 1-11	11.69	0	32.76	5.2	0.205	468	14 R		.558	.244	.03	12.5	82.1	70-75
R6 0 1-11	11.69	0	32.6	5.36	0.156	468	168	.000	.557	.244	.03	12.5	81.6	70-75
S5 0 1-11	11.69	0	32.36	5.61	0.08	469	168	.000	.557	.244	.03	12.5	80	69-74

Table A.12 Mix Proportions and Initial Mix Temperatures for Mortars Containing Type II Cement

BATCH	MORTAR MIXES										VOLUME PER CUBIC FOOT			INITIAL MIX TEMP	AMBIENT RANGE
	BATCH WEIGHTS (LBS)					ADMIXTURE					SAND	WATER	AIR		
	CEMENT	FLYASH	SAND	WATER	MC W/(C+FA)		CEMENT	FLYASH	SAND	WATER				AIR	
825 0 I	11.69	0	32.86	5.11	.0236	469	168	.000	557	245	.03	12.5	82	71-76	
826 20C I	8.8	1.98	30.96	4.7	.0236	469	135	.034	561	240	.03	12.42	82.3	71-76	
827 27.5C I	7.98	2.72	30.8	4.82	.0181	468	123	.047	562	239	.03	12.39	79.9	68-74	
828 35C I	7.15	3.47	30.8	4.78	.0181	467	110	.059	563	237	.03	12.35	81.1	68-74	
829 20B I	8.8	1.72	30.8	4.73	.0181	467	136	.034	564	236	.03	12.31	79.7	68-74	
830 27.5B I	7.98	2.37	30.8	4.65	.0181	467	124	.047	567	233	.03	12.25	80.4	68-74	
831 35B I	7.15	3.02	31.03	4.33	.0257	467	111	.060	569	229	.03	12.17	79.1	70-75	
832 20D I	8.8	1.92	30.25	4.6	.0257	467	137	.034	556	242	.03	12.39	80.6	70-75	
833 27.5D I	7.98	2.63	31.03	4.55	.0257	468	123	.047	563	237	.03	12.35	80.7	70-75	
834 35D I	7.15	3.35	31.03	5.3	.0257	544	106	.057	543	263	.03	12.35	79.2	70-75	
835 35D I	7.15	3.35	30.95	4.56	.023	466	111	.060	565	235	.03	12.31	78.9	68-73	
836 20A I	8.8	1.65	30.95	4.54	.023	466	136	.034	566	234	.03	12.29	78.9	68-73	
837 27.5A I	7.98	2.26	30.95	4.44	.023	466	124	.047	568	230	.03	12.2	79.8	68-73	
838 35A I	7.64	3.08	33.05	4.65	.023	467	112	.060	571	227	.03	12.12	80.7	68-73	
842 0 I	16	0	22.42	7.32	.019	467	236	.000	392	342	.03	16.77	86.3	69-73	
843 0 I	6	0	33.63	2.57	.019	467	107	.000	709	155	.03	10.28	81.6	69-73	
R2 0 I	11.69	0	32.76	5.2	.0205	468	168	.000	538	244	.03	12.5	83.2	70-74	
R5 0 I	11.69	0	32.6	5.36	.0156	468	17 R	.000	557	244	.03	12.5	81.7	68-73	
56 0 I	11.69	0	32.36	5.61	.008	469	168	.000	537	244	.03	12.5	80.8	71-75	
57 0 I	11.69	0	32.36	5.61	.008	469	17.5	.000	557	244	.03	12.5	81.8	71-75	
59 27.5B I	7.98	2.37	30.76	4.69	.017	468	26.5	.049	565	232	.03	12.25	76.8	70-75	
510 27.5C I	7.98	2.72	30.76	4.69	.017	452	26.5	.056	561	231	.03	12.39	83.8	70-75	

Table A.13 Mix Proportions and Initial Mix Temperatures for Mortars Containing Type III Cement

BATCH	CEMENT TYPE III	BATCH WEIGHTS (LBS)					VOLUME PER CURIC FOOT					SAMPLE WEIGHT	INITIAL MIX TEMP	AMBIENT RANGE
		CEMENT	FLYASH	SAND	WATER	MC W/(C+FA)	ADMIXTURE (#1)	CEMENT	FLYASH	SAND	WATER			
B12 0 III	11.69	0	33.21	4.76	0.345	469	.168	.000	.557	.245	.03	12.5	81.4	75-78
B13 35A III	7.64	3.08	33.42	4.28	0.345	467	.112	.060	.571	.227	.03	12.12	81.6	75-78
B14 27.5A III	7.98	2.26	31.29	4.11	0.345	468	.124	.047	.568	.231	.03	12.2	80	75-78
B15 20A III	8.8	1.65	31.29	4.21	0.345	468	.136	.034	.565	.235	.03	12.29	81.3	75-78
B16 200 III	8.8	1.92	30.64	4.99	.013	468	.135	.034	.561	.239	.03	12.39	83.3	68-75
B17 27.50 III	7.98	2.63	30.64	4.94	.013	468	.123	.047	.563	.238	.03	12.35	82.5	68-75
B18 350 III	7.15	3.35	30.64	4.88	.013	468	.111	.059	.564	.235	.03	12.31	83	68-75
B19 208 III	8.8	1.72	30.82	4.89	0.188	484	.135	.034	.559	.242	.03	12.31	83.4	69-74
B20 27.5B III	7.98	2.37	30.82	4.63	0.188	467	.124	.047	.567	.233	.03	12.25	82.6	69-74
B21 358 III	7.15	3.02	30.82	4.54	0.188	467	.111	.060	.569	.229	.03	12.17	86.1	69-74
B22 20C III	8.8	1.98	30.82	4.84	0.188	468	.135	.034	.561	.240	.03	12.42	85.5	69-74
B23 27.5C III	7.98	2.72	30.96	4.66	0.236	468	.123	.047	.562	.239	.03	12.39	81.8	71-76
B24 35C III	7.15	3.47	30.96	4.6	0.236	466	.110	.060	.563	.237	.03	12.35	82.4	71-76
B41 208 III	8.8	1.72	30.63	4.89	0.127	467	.137	.030	.567	.237	.03	12.31	78.8	70-81
B3 0 III	11.69	0	32.6	5.36	0.156	468	.168	.000	.557	.244	.03	12.5	82.9	68-73
R4 0 III	11.69	0	32.6	5.36	0.156	468	.17 R	.000	.557	.244	.03	12.5	81.9	68-73
52 0 III	11.69	0	32.2	5.67	.003	469	52.5	.000	.560	.241	.03	12.5	82.7	70-74
58 0 III	11.69	0	32.65	5.32	.017	469	28.5	.000	.557	.244	.03	12.5	77.9	70-75
511 27.5C III	7.98	2.72	30.63	4.99	0.127	468	26.5	.123	.562	.239	.03	12.39	78	70-81
512 27.5B III	7.98	2.97	30.63	4.81	0.127	467	26.5	.041	.570	.234	.03	12.25	77.7	70-81

APPENDIX B
TEST RESULTS

Table B.1 Temperature Rise Test Results for Mortar Containing Type I-II Cement

Batch	Fly Ash	Cement Replacement		Admixture*	Peak Temp.	Time to 95%
		By Fly Ash (%)			Rise (° F)	of Peak (Hours)
A13	-	0		0	75.3	10.0
A16	-	0		0	78.3	8.3
A17	A	35		0	49.5	9.5
A18	C	35		0	72.6	11.5
A19	-	0		0	76.0	11.5
A20	A	35		0	51.9	12.0
A21	C	35		0	77.0	14.0
A24	A	35		0	40.8	11.0
A25	A	35		0	39.6	13.0
A26	-	0		0	70.0	11.5
A29	A	35		0	48.7	10.8

*R denotes addition of the retarder.

S denotes addition of the superplasticizer.

Table B.2 Temperature Rise Test Results for Mortar Containing Type I-II Cement

Batch	Fly Ash	Cement Replacement		Peak Temp. Rise (° F)	Time to 95% of Peak (Hours)
		By Fly Ash (%)	Admixture* (oz/cwt)		
B39	-	0	0	63.1	11.5
B5	A	20	0	50.0	11.8
B4	A	27.5	0	44.9	11.8
B40	A	35	0	44.7	11.5
B9	B	20	0	49.0	12
B10	B	27.5	0	46.9	12.2
B11	B	35	0	41.7	13.3
B6	C	20	0	60.9	14.2
B7	C	27.5	0	60.9	15.7
B8	C	35	0	60.8	16.2
B2	D	20	0	59.3	15.7
B3	D	27.5	0	57.0	17.8
B1	D	35	0	55.9	19.7
R1	-	0	4R	67.0	14.3
R6	-	0	5R	67.0	16.3
S5	-	0	8S	65.7	12.7

* R denotes addition of the retarder.

S denotes addition of the superplasticizer.

**Table B.3 Temperature Rise Test Results for Mortar Containing
Type I Cement**

Batch	Fly Ash	Cement Replacement		Peak Temp. Rise (° F)	Time to 95% of Peak (Hours)
		By Fly Ash (%)	Admixture* (oz/cwt)		
B25	-	0	0	71.4	9.7
B36	A	20	0	58.2	10.7
B37	A	27.5	0	55.9	10.7
B38	A	35	0	51.3	11.0
B29	B	20	0	58.2	10.8
B30	B	27.5	0	56.0	11.0
B31	B	35	0	51.4	12.0
B26	C	20	0	70.8	11.0
B27	C	27.5	0	70.9	12.3
B28	C	35	0	73.3	13.3
B32	D	20	0	66.5	12.0
B33	D	27.5	0	68.9	13.3
B35	D	35	0	64.0	15.8
B34	D	35	0	64.0	15.7
B42	-	0	0	108.0	9.2
B43	-	0	0	44.0	9.2
R2	-	0	4R	72.7	11.8
R5	-	0	5R	72.5	13.0
S6	-	0	5S	75.3	10.3
S7	-	0	8S	72.7	10.3
S9	B	27.5	8S	56.8	13.5
S10	C	27.5	8S	71.1	12.7

*R denotes addition of the retarder.

S denotes addition of the superplasticizer.

Table B.4 Temperature Rise Test Results for Mortar Containing Type III Cement

Batch	Fly Ash	Cement Replacement		Peak Temp. Rise (° F)	Time to 95% of Peak (Hours)
		By Fly Ash (%)	Admixture* (oz/cwt)		
B12	-	0	0	80.8	7.7
B15	A	20	0	67.0	8.3
B14	A	27.5	0	62.1	8.7
B13	A	35	0	59.8	8.3
B41	B	20	0	66.5	9.3
B20	B	27.5	0	65.1	8.5
B21	B	35	0	57.8	8.3
B22	C	20	0	78.9	8.5
B23	C	27.5	0	76.1	7.8
B24	C	35	0	70.1	8.7
B16	D	20	0	76.6	10.3
B17	D	27.5	0	77.8	10.8
B18	D	35	0	77.5	11.8
B19	B	20	0	65.3	8.5
R3	-	0	4R	80.6	9.0
R4	-	0	5R	78.9	9.7
S2	-	0	15S	81.6	8.2
S8	-	0	8S	82.4	8.3
S11	C	27.5	8S	77.5	10.8
S12	B	27.5	8S	64.5	10.3

*R denotes addition of the retarder.

S denotes addition of the superplasticizer.

Table B.5 Compressive Strength of Mortar Cubes with Type I-II Cement

Fly Ash	Cement Replacement		7-Day Strength (psi)	28-Day Strength (psi)
	By Fly Ash (%)	Admixture* (oz/cwt)		
-	0	0	5760	8220
A	20	0	5830	7450
A	27.5	0	4430	6840
A	35	0	5250	7560
B	20	0	5190	7630
B	27.5	0	4880	7490
B	35	0	5230	7490
C	20	0	6360	9180
C	27.5	0	6010	8510
C	35	0	6500	8930
D	20	0	5040	6890
D	27.5	0	6930	9680
D	35	0	6670	9030
-	0	4R	6690	9060
-	0	5R	6390	8000
-	0	8S	6630	8320

* R denotes addition of the retarder.

S denotes addition of the superplasticizer.

Table B.6 Compressive Strength of Mortar Cubes with Type I Cement

Fly Ash	Cement Replacement		7-Day Strength (psi)	28-Day Strength (psi)
	By Fly Ash (%)	Admixture* (oz/cwt)		
-	0	0	7380	8130
A	20	0	6170	7870
A	27.5	0	5980	7840
A	35	0	5050	6890
B	20	0	5610	7240
B	27.5	0	5550	6750
B	35	0	5230	6750
C	20	0	7030	8500
C	27.5	0	6790	8200
C	35	0	6810	8340
D	20	0	6700	8280
D	27.5	0	7140	9060
D	35	0	6570	8160
-	0	4R	7260	8250
-	0	5R	6610	7380
-	0	5S	7380	7350
-	0	8S	6820	7710
B	27.5	8S	5580	7390
C	27.5	8S	6080	7660

* R denotes addition of the retarder.

S denotes addition of the superplasticizer.

Table B.7 Compressive Strength of Mortar Cubes with Type III Cement

Fly Ash	Cement Replacement		7-Day Strength (psi)	28-Day Strength (psi)
	By Fly Ash (%)	Admixture* (oz/cwt)		
-	0	0	8110	9600
A	20	0	6550	8540
A	27.5	0	6560	8380
A	35	0	6030	8210
B	20	0	6600	8280
B	27.5	0	6440	8090
B	35	0	5740	7310
C	20	0	7210	8750
C	27.5	0	7140	8870
C	35	0	7290	8700
D	20	0	7410	9090
D	27.5	0	7240	8950
D	35	0	7020	8980
-	0	4R	7620	8260
-	0	5R	7410	8250
-	0	15S	7590	8920
-	0	8S	7820	9100
C	27.5	8S	6500	8120
B	27.5	8S	6120	7610

* R denotes addition of the retarder.

S denotes addition of the superplasticizer.

Table B.8 Flow of Mortar with Type I and Type III Cement

Fly Ash	Cement Replacement		Type I Cement (Flow in%)	Type III Cement (Flow in %)
	By Fly Ash (%)	Admixture* (oz/cwt)		
-	0	0	127	86
A	20	0	126	83
A	27.5	0	128	83
A	35	0	127	96
B	20	0	136	122
B	27.5	0	138	124
B	35	0	143	122
C	20	0	129	117
C	27.5	0	128	123
C	35	0	129	126
D	20	0	135	109
D	27.5	0	127	115
D	35	0	132	122
-	0	4R	126	97
-	0	5R	129	102
-	0	5S	143	-
-	0	8S	138	109
-	0	15S	-	128

* R denotes addition of the retarder.

S denotes addition of the superplasticizer.

REFERENCES

1. Davis, R.E.; Carlson, R.W.; Kelly, J.W.; and Davis, H.E., Properties of Cements and Concretes Containing Fly Ash"; Journal of the American Concrete Institute, *Proceedings*, Vol. 33, May- June 1937, pp. 577-612.
2. ACI Committee 207, "Mass Concrete for Dams and other Massive Structures", *ACI Manual of Concrete Practice 1978*, Part 1.
3. Berry, E.E. and Malhotra, V.M.; *Fly Ash in Concrete*, Canadian Government Publishing Centre, Ottawa, 1986.
4. ACI Committee 305, "Hot Weather Concreting", *ACI Manual of Concrete Practice 1983*, Part 2.
5. American Society for Testing and Materials, *Annual Book of ASTM Standards*, "Standard Specification for Blended Hydraulic Cements", ASTM C595, Philadelphia, 1975.
6. Helmuth, Richard, *Fly Ash in Cement and Concrete*, Portland Cement Association, Skokie, Illinois, 1987.
7. American Society for Testing and Materials, *Annual Book of ASTM Standards*, "Specification for Fly Ash and Raw or Calcined Natural Pozzolan for Use as a Mineral Admixture in Portland Cement Concrete", ASTM C618-78, Philadelphia, 1978.
8. Mindess, Sidney and Young, Francis; *Concrete*, Prentice-Hall Inc., Englewood Cliffs, NJ, 1981.
9. Czernin, W., *Cement Chemistry and Physics for Civil Engineers*, Second Edition, Foreign Publication Inc., New York, 1980.
10. Mehta, K.P., *Concrete : Structure, Properties, and Materials*, Prentice - Hall Inc., Englewood Cliffs, NJ, 1986.
11. Bensted, John, "Early Hydration of Portland Cement - Effects of Water/Cement Ratio", *Cement and Concrete Research*, Vol. 13, 1983, pp. 493-498.
12. Berry, E.E. and Malhotra, V.M., "Fly Ash in Concrete - A Critical Review," *Journal of the American Concrete Institute, Proceedings*, VOL. 77, NO. 8, March-April 1980, pp. 59-73.

13. Dalziel, J.A., and Gutteridge, W.A.; "The Influence of Pulverized-Fuel Ash Upon the Hydration Characteristics and Certain Physical Properties of a Portland Cement Paste", *Technical Report 560*, Cement and Concrete Association, January 1986.
14. Popovics, Sandor, "What Do We Know about the Contribution of Fly Ash to the Strength of Concrete ?", Proceedings, *Second International Conference on the Use of Fly Ash, Silica Fume, and Natural Pozzolans in Concrete*, SP 91-14, American Concrete Institute, Detroit, 1986, pp. 313-331.
15. McKerral, W.C., Ledbetter, W.B., and Teague, D.J., "Analysis of Fly Ashes Produced in Texas", *Research Report 240-1*, Texas Transportation Institute, Texas A&M University, Jan. 1981.
16. Timoshenko, S., *Theory of Elasticity*, First Edition, Maple Press Company, 1934.
17. Bamforth, P.B., "In Situ Measurement of the Effect of Partial Portland Cement Replacement Using Either Fly Ash or Ground Granulated Blast Furnace Slag on the Performance of Mass Concrete", *Proceedings*, Institute of Civil Engineers, Vol. 69, London, 1980, pp. 777-800.
18. ACI Committee 207, "Effect of Restraint, Volume Change, and Reinforcement on Cracking of Massive Concrete", *ACI Manual of Concrete Practice 1983*, Part 1.
19. Dunstan, M.R.H. and Mitchell, P.B., "Results of a Thermocouple Study in Mass Concrete in the Upper Tamar Dam", *Proceedings*, Institute of Civil Engineers, Vol. 60, London, 1976, pp. 27-52.
20. Jacquin, Pierre and Orth, J.F., "Mass Concrete Practices in France", SP-6, *ACI Committee 207 : Symposium on Mass Concrete*, American Concrete Institute, Detroit, 1963.
21. ACI Committee 306, "Cold Weather Concreting", *ACI Manual of Concrete Practice 1983*, Part 2.
22. ACI Committee 211, "Standard Practices for Selecting Proportions for Normal, Heavyweight, and Mass Concrete", *ACI Manual of Concrete Practice 1983*, Part 1.

23. Murdock, L.J. and Brook, K.M.; *Concrete Materials and Practice*, Fifth Edition, John Wiley & Sons, New York, 1979.
24. Smith, I.A., "The Design of Fly Ash Concrete", *Proceedings*, Institute of Civil Engineers, Vol. 36, London, 1967, pp.769-790.
25. Peterman, M.B., Carrasquillo, R.L.; "Production of High Strength Concrete", *Research Report 315-1F*, Center for Transportation Research, University of Texas at Austin, October 1983.
26. Archuleta, L.G., Tikalsky, P. J., and Carrasquillo, R.L.; "Production of Concrete Containing Fly Ash for Structural Applications", *Research Report 364-1*, Center for Transportation Research, University of Texas at Austin, May 1986.
27. Olek, J., Tikalsky, P.J., and Carrasquillo, R.L.; "Production of Concrete Containing Fly Ash for Pavement Applications", *Research Report 364-2* Center for Transportation Research, University of Texas at Austin, May 1986.
28. Lin, C.Y., and Hwang, C.L., "The Effect of Fly Ash on Properties of Cement Mortar", Supplementary Papers, *Second International Conference on the Use of Fly Ash, Silica Fume, Slag, and Natural Pozzolans in Concrete*, SP 91, American Concrete Institute, 1986, pp. 1-32.
29. Lea, F.M., *The Chemistry of Cement and Concrete*, Chemical Publishing Company, New York, 1971.
30. Helmuth, R.A., "Water-Reducing Properties of Fly Ash in Cement Pastes, Mortars, and Concretes: Causes and Test Methods", *Proceedings, Second International Conference on the Use of Fly Ash, Silica Fume, Slag, and Other Mineral By-Products in Concrete*, SP 91-34, American Concrete Institute, Detroit, 1986, pp. 723-741.
31. *Concrete Admixtures Handbook: Properties, Science, and Technology*, ed. V.S. Ramachandran, Noyes Publications, Park Ridge, NJ, 1984.
32. Meland, I., "Influence of Condensed Silica Fume and Fly Ash on the Heat Evolution in Cement Pastes", *Proceedings, The International Conference on the Use of Fly Ash, Silica Fume, Slag, and Other Mineral By-Products in Concrete*, SP 79, American Concrete Institute, Detroit, 1983, pp. 665- 676.
33. Zilveti, A., Sooi, T.K., Klingner, R.E., Carrasquillo, R.L., Jirsa, J.O.; "Effect of Superplasticizers on the Bond Behavior of Reinforcing Steel in Concrete

- Members", *Research Report 383-2F*, Center for Transportation Research, University of Texas at Austin, November 1985.
34. Musser, P.L., Carrasquillo, R.L., Jirsa, J.O., and Klingner, R.E.; "Anchorage and Development of Reinforcement in Concrete Made Using Superplasticizers", *Research Report 383-1*, Center for Transportation Research, University of Texas at Austin, Sept. 1985.
 35. Dezhen, G., Dayo, X., and Zhang, L.; "Model of Mechanism for Napthalene Series Water-Reducing Agent", *Journal of the American Concrete Institute, Proceedings*, Vol. 79, Sept - Oct 1982, pp. 378-386.
 36. Khalil, S.M., and Ward, M.A.; "Effect of Sulfate Content of Cement upon Heat Evolution and Slump Loss of Concretes containing High-Range Water Reducers", *Magazine of Concrete Research*, Vol. 32, No. 110, March 1980, pp. 28-38.
 37. American Society of Testing and Materials, *Annual Book of ASTM Standards*, "Specification for Chemical Admixtures for Concrete", ASTM C494-82, Philadelphia, 1984.
 38. American Society of Testing and Materials, *Annual Book of ASTM Standards*, "Compressive Strength of Hydraulic Cement", ASTM C109-86, Philadelphia, 1986.
 39. Texas State Department of Highways and Public Transportation, *Supplement #2 to Construction Bulletin C-11*, January 1986.
 39. American Society of Testing and Materials, *Annual Book of ASTM Standards*, "Test Method for Air Content of Hydraulic Cement Mortar", ASTM C185-80, Philadelphia, 1984.
 40. American Society of Testing and Materials, *Annual Book of ASTM Standards*, "Specification for Mortar for Unit Masonry", ASTM C270-82, Philadelphia, 1984.
 41. American Society of Testing and Materials, *Annual Book of ASTM Standards*, "Mechanical Mixing of Hydraulic Cement Pastes and Mortars of Plastic Consistency", ASTM C305-82, Philadelphia, 1984.
 42. Soroka, I., *Portland Cement Paste and Concrete*, Chemical Publishing Co., Inc., New York, 1980.