

1. Report No. FHWA/TX-98/1265-2		2. Government Accession No.		3. Recipient's Catalog No.	
4. Title and Subtitle CONSOLIDATION OF CONCRETE WITH EPOXY-COATED REINFORCEMENT				5. Report Date April 1997	
				6. Performing Organization Code	
7. Author(s) Reagan S. Herman and James O. Jirsa				8. Performing Organization Report No. 1265-2	
9. Performing Organization Name and Address Center for Transportation Research The University of Texas at Austin 3208 Red River, Suite 200 Austin, TX 78705-2650				10. Work Unit No. (TRAIS)	
				11. Contract or Grant No. 0-1265	
12. Sponsoring Agency Name and Address Texas Department of Transportation Research and Technology Transfer Section/Construction Division P.O. Box 5080 Austin, TX 78763-5080				13. Type of Report and Period Covered Research Report (9/96-4/97)	
				14. Sponsoring Agency Code	
15. Supplementary Notes Project conducted in cooperation with the Federal Highway Administration.					
16. Abstract <p>The specific objectives of this testing are as follows: (1) assess the damage to epoxy-coated reinforcing bars produced by metallic head and rubber head vibrators; (2) assess the quality of consolidation obtained with rubber head vibrators as compared with metallic head vibrators; (3) determine the degree and quality of consolidation obtained with rubber head vibrators as compared with metallic head vibrators through a visual examination and by measuring density of cores from vibrated specimens; and (4) make recommendations on the appropriate type of internal vibrator to be used in conjunction with epoxy-coated reinforcement.</p> <p>Several test specimens were constructed to evaluate vibrator damage to coated reinforcing bars. Companion specimens simulating column, footing, and slab sections were assembled. One specimen was vibrated with the rubber vibrator head, while the metal head was used to consolidate the companion specimen. The amount of vibrator damage to reinforcement was assessed visually. For each specimen type, the metal vibrator heads produced significantly more damage than did rubber heads.</p> <p>In a second series of tests, the vibratory action produced by rubber and metal vibrator heads was recorded using accelerometers. The measurements showed that during consolidation, the metal head produced more significant horizontal waves in the concrete than did the rubber head. Horizontal particle accelerations with the metal head were greater than those with the rubber head, both close to the insertion point of the vibrator, and farther out from this point. More significant differences were noted between the two heads at points farther from the point of insertion.</p> <p>Finally, a group of specimens consolidated using metal and rubber vibrator heads was cured and cores were removed. Cores from both metal and rubber head specimens revealed that more voids were located under reinforcing bars farther from the point of vibrator insertion than there were closer to the insertion point, even when the concrete at both locations was adequately consolidated.</p>					
17. Key Words Epoxy-coated reinforcing bars, rubber head vibrators, metallic head vibrators			18. Distribution Statement No restrictions. This document is available to the public through the National Technical Information Service, Springfield, Virginia 22161.		
19. Security Classif. (of report) Unclassified		20. Security Classif. (of this page) Unclassified		21. No. of pages 102	22. Price

CONSOLIDATION OF CONCRETE WITH EPOXY-COATED REINFORCEMENT

BY

REAGAN S. HERMAN AND JAMES O. JIRSA

Research Report No. 1265-2

Research Project 0-1265

“Structural Integrity of Epoxy-Coated Bars”

conducted for the

Texas Department of Transportation

in cooperation with the

U.S. Department of Transportation

Federal Highway Administration

by the

CENTER FOR TRANSPORTATION RESEARCH

BUREAU OF ENGINEERING RESEARCH

THE UNIVERSITY OF TEXAS AT AUSTIN

April 1997

IMPLEMENTATION

Rubber vibrator heads should be specified for consolidation of concrete with epoxy-coated reinforcement. The use of rubber heads will result in less damage to coated reinforcement, while adherence to proper vibration procedures will ensure the concrete is adequately consolidated.

With both metal and rubber vibrator heads, the radius of influence for adequate consolidation may be larger than that for removal of air voids beneath reinforcement. Taking the area of influence for removing air voids as 75% of that required for consolidation seems to be adequate. The subsequent reduction of spacing of vibrator insertions will help to ensure that air voids beneath bars are adequately removed and that the concrete is well consolidated.

Vibrator operators should be well trained in proper consolidation procedures, especially when the concrete is reinforced with epoxy-coated bars. Operators should not deliberately contact coated reinforcement with either metal or rubber heads, and they should avoid cursory contact between the vibrating head and reinforcing bars. The vibrator should not be dragged over coated bars, nor should the head be forced into tight areas between a coated reinforcement cage and formwork. Operators should be instructed on proper spacings of insertion points for concrete vibrators, and special care should be taken to ensure concrete reinforced with epoxy-coated reinforcement is adequately consolidated.

Since concrete placement is the last possible procedure during which the coating on reinforcement can be damaged before it is put into service, and since damage during concrete placement cannot be seen nor repaired, it is important that all possible means be used to limit vibrator induced damage. Furthermore, since the quality of concrete consolidation has substantial impact on the corrosion performance of epoxy-coated reinforcement, it is also important to ensure that the concrete in place is well consolidated. The proper use of rubber vibrator heads, with a sufficient schedule of insertion points, should result in the manufacture of the best possible product of concrete reinforced with epoxy-coated bars.

NOT INTENDED FOR CONSTRUCTION,
BIDDING, OR PERMIT PURPOSES

James O. Jirsa, Texas P.E. #31360

Research Supervisor

The contents of this report reflect the views of the authors, who are responsible for the facts and accuracy of the data presented herein. The contents do not necessarily reflect the views of the Texas Department of Transportation. This report does not constitute a standard, specification, or regulation.

TABLE OF CONTENTS

CHAPTER ONE — INTRODUCTION	1
1.1 The Problem.....	1
1.2 Corrosion of Steel in Concrete	1
1.3 Epoxy-Coated Reinforcement	3
1.3.1 Damage to Epoxy-Coated Reinforcing Bars	3
1.4 Research Objectives.....	5
1.5 Review of Concrete Consolidation	5
1.5.1 Internal Concrete Vibrators	6
1.5.2 Concrete Placement Procedure	8
1.5.3 Under-vibration versus Over-vibration.....	10
1.5.4 Designing for Concrete Placement	10
1.5.5 Selecting an Internal Vibrator.....	11
1.6 Organization of Research	11
CHAPTER TWO — EVALUATION OF EPOXY COATING DAMAGE DURING CONCRETE PLACEMENT	13
2.1 General.....	13
2.2 Damage to Coating Prior to Placement of Concrete	13
2.3 Evaluation Tests of Coating Damage During Concrete Placement	14
2.3.1 Test Specimens	14
2.3.2 Test Procedure	19
2.4 Test Results.....	24
2.4.1 General Observations.....	24
2.4.2 Column Specimens	24
2.4.3 Footing Specimens.....	26
2.4.4 Slab Specimens	28
2.5 Discussion of Results.....	29
2.6 Conclusions	32
CHAPTER 3 — EVALUATION OF CONSOLIDATION DURING VIBRATION IN FRESH CONCRETE.....	37
3.1 Introduction	37
3.1.1 Vibration in Concrete	37
3.1.2 Mechanical Concrete Vibration	37
3.1.3 Key Factors in Concrete Vibration	38
3.1.4 Effect of Concrete Mix on Consolidation.....	39
3.2 Vibration Test in Fresh Concrete.....	39
3.2.1 Test Specimens	39
3.2.2 Test Procedure	41
3.3 Test Results.....	41
3.3.1 General Observations.....	41
3.3.2 Data Recorded During Test	43
3.3.3 Discussion of Results.....	44
3.4 Conclusions	51

CHAPTER 4 — EVALUATION OF CONSOLIDATION IN HARDENED CONCRETE AFTER CONCRETE VIBRATION	53
4.1 General	53
4.2 Consolidation Test	54
4.2.1 Test Specimens.....	54
4.2.2 Test Procedure.....	56
4.2.3 Coring Schedule	64
4.3 Test Results	64
4.3.1 General Observations	64
4.3.2 Air Void Distribution	69
4.3.3 Concrete Density and Void Content.....	75
4.4 Discussion of Results	75
4.5 Conclusions	76
CHAPTER 5 — SUMMARY, CONCLUSIONS, AND RECOMMENDATIONS	79
5.1 Summary	79
5.1.1 Damage to Epoxy Coating	79
5.1.2 Measurement of Vibration in Fresh Concrete	79
5.1.3 Evaluation of Consolidation in Hardened Concrete.....	80
5.2 Conclusions	80
5.3 Recommendations	80
APPENDIX — CONCRETE MIX SPECIFICATIONS.....	83
CONCRETE USED IN COLUMN DAMAGE TEST	83
CONCRETE USED IN FOOTING DAMAGE TEST.....	83
CONCRETE USED IN SLAB DAMAGE TEST AND HARDENED CONCRETE CONSOLIDATION TEST.....	84
CONCRETE USED IN CONSOLIDATION TEST IN FRESH CONCRETE	84
BIBLIOGRAPHY	85

LIST OF FIGURES

Figure 1. 1 Corrosion cell in reinforced concrete	2
Figure 1. 2 Concrete placement procedure in precast pier cap	4
Figure 1. 3 Consolidation of concrete in bridge deck	7
Figure 1. 4 Area of influence for concrete vibrator	7
Figure 1. 5 Overlap of areas of influence	9
Figure 1. 6 Action of internal vibrator ⁸	9
Figure 2. 1 Details of column specimen	15
Figure 2. 2 Details of column reinforcement	16
Figure 2. 3 Details of footing specimen.....	17
Figure 2. 4 Details of footing reinforcement	17
Figure 2. 5 Details of deck specimen.....	18
Figure 2. 6 Details of deck reinforcement	18
Figure 2. 7 Placing concrete in column form.....	19
Figure 2. 8 Consolidating column specimen.....	19
Figure 2. 9 Lifting column reinforcement cage from concrete	20
Figure 2. 10 Washing column cages after vibration	21
Figure 2. 11 Placing concrete in footig form	21
Figure 2. 12 Consolidating footing specimen	22
Figure 2. 13 Lifting footing reinforcement mat from concrete.....	22
Figure 2. 14 Washing footing reinforcement mat.....	23
Figure 2. 15 Consolidating slab specimen	23
Figure 2. 16 Damage to epoxy coating from metal vibrator head	25
Figure 2. 17 Histogram of damage percentages for 0.3 m (1 ft.) horizontal bar sections from column, footing and slab specimens	30
Figure 2. 18 Histogram of damage percentages (0 - 0.34% range)	31
Figure 2. 19 Vibration damage to epoxy coating.....	33
Figure 2. 20 Coating damage with metal vibrator head.....	34
Figure 3. 1 Recording station locations	40
Figure 3. 2 Data station positions	40
Figure 3. 3 Accelerometer in receptacle box	41
Figure 3. 4 Accelerometer features.....	42
Figure 3. 5 Accelerometer orientation	42
Figure 3. 6 Data acquisition system.....	43
Figure 3. 7 Typical power spectrum record.....	44
Figure 3. 8 Typical time record	45
Figure 3. 9 Metal (top) and rubber vibrator heads	50
Figure 4. 1 Blister at bottom side of coated bar	54
Figure 4. 2 Corrosion at blisters on coated bars	55
Figure 4. 3 Area of influence and specimen size	55
Figure 4. 4 Reinforcement of Specimens M8 and R8.....	56
Figure 4. 5 Layout of reinforcement in Specimens M8 and R8.....	57
Figure 4. 6 Layout of reinforcement in specimens M17 and R17	58
Figure 4. 7 Layout of reinforcement in Specimens M28 and R28.....	59
Figure 4. 8 Layout of reinforcement in Specimen R18	60
Figure 4. 9 Layout of reinforcement in Specimen R30	61
Figure 4. 10 Placing concrete in specimen from overhead bucket	62

Figure 4. 11 Consolidation of Specimen R8	62
Figure 4. 12 Consolidation of Specimen M17	63
Figure 4. 13 Coring reinforced concrete test specimen.....	64
Figure 4. 14 Cores from consolidation test specimens.....	65
Figure 4. 15 Specimens M8 and R8 after coring.....	65
Figure 4. 16 Core maps for Specimens R8 and M8	66
Figure 4. 17 Splitting cores at level of reinforcement.....	67
Figure 4. 18 Reinforcing bar extracted from core	67
Figure 4. 19 Smooth and shiny surface under epoxy-coated rebar	68
Figure 4. 20 Dull and rough surface under black rebar.....	68
Figure 4. 21 Typical distribution of voids under rebar.....	69
Figure 4. 22 Locations where voids were often located.....	70
Figure 4. 23 Voids under top and bottom bars from Specimen R17	71
Figure 4. 24 Large voids under #8 rebar	72
Figure 4. 25 Voids under bars from Specimen R8	73
Figure 4. 26 Voids under bars from Specimen M8	74

LIST OF TABLES

Table 3. 1 Peak Frequency from Horizontal Surface Measurements	45
Table 3. 2 Peak Frequency from Vertical Surface Measurements.....	46
Table 3. 3 Peak Frequency from Horizontal Side Measurements	46
Table 3. 4 Peak Frequency from Vertical Side Measurements.....	46
Table 3. 5 Average Peak Frequency	47
Table 3. 6 Horizontal Accelerations at Stations A and B	48
Table 3. 7 Horizontal Accelerations at Station C	49
Table 3. 8 Vertical Accelerations at Stations A and B	49
Table 3. 9 Vertical Accelerations at Station C.....	50
Table 4. 1 Permeable Pore Space.....	75

SUMMARY

The specific objectives of this testing are as follows: (1) assess the damage to epoxy-coated reinforcing bars produced by metallic head and rubber head vibrators; (2) assess the quality of consolidation obtained with rubber head vibrators as compared with metallic head vibrators; (3) determine the degree and quality of consolidation obtained with rubber head vibrators as compared with metallic head vibrators through a visual examination and by measuring density of cores from vibrated specimens; and (4) make recommendations on the appropriate type of internal vibrator to be used in conjunction with epoxy-coated reinforcement.

Several test specimens were constructed to evaluate vibrator damage to coated reinforcing bars. Companion specimens simulating column, footing, and slab sections were assembled. One specimen was vibrated with the rubber vibrator head, while the metal head was used to consolidate the companion specimen. The amount of vibrator damage to reinforcement was assessed visually. For each specimen type, the metal vibrator heads produced significantly more damage than did rubber heads.

In a second series of tests, the vibratory action produced by rubber and metal vibrator heads was recorded using accelerometers. The measurements showed that during consolidation, the metal head produced more significant horizontal waves in the concrete than did the rubber head. Horizontal particle accelerations with the metal head were greater than those with the rubber head, both close to the insertion point of the vibrator, and farther out from this point. More significant differences were noted between the two heads at points farther from the point of insertion.

Finally, a group of specimens consolidated using metal and rubber vibrator heads was cured and cores were removed. Cores from both metal and rubber head specimens revealed that more voids were located under reinforcing bars farther from the point of vibrator insertion than there were closer to the insertion point, even when the concrete at both locations was adequately consolidated.

CHAPTER ONE

INTRODUCTION

1.1 The Problem

Damage to reinforced concrete structures due to corrosion is an extraordinary problem that costs millions of dollars per year in the United States alone. Structural and civil engineers who are responsible for the design, maintenance, and rehabilitation of reinforced concrete structures are well aware of the serious effects of reinforcement corrosion, and several different approaches have been used to attempt to stop, or at least slow, the process of corrosion in concrete; the use of epoxy-coated reinforcement is one such approach.

1.2 Corrosion of Steel in Concrete

The corrosion resistance of steel in concrete would remain indefinitely if the concrete cover around the reinforcement was able to keep all air and water from reaching the steel.¹ But, when the concrete cover is thin or porous, or if the environment to which the concrete is exposed is severe, elements can penetrate the concrete cover and the reinforcement may begin to corrode.

Concrete is usually a “friendly” environment for the steel. The alkalinity of the concrete causes the steel to develop a passive condition on its surface, and because of this passive film there is essentially no corrosion.¹ Also, the high electrical resistance of concrete makes it a low conductive electrolyte, which limits the flow of ions required in the corrosion process. Furthermore, the high calcium content of concrete’s pore solution causes mineral scales to form on the surface of the steel, preventing the base metal from reacting with its environment. However, the protective atmosphere of the concrete may break down due to a loss of alkalinity in the concrete, or penetration of aggressive ions, such as chlorides, into the concrete to the reinforcement, or a combination of both these factors. In the absence of the protective atmosphere the steel will likely corrode, and may do so very rapidly.

The corrosion of a metal occurs through an electrochemical mechanism. Corrosion requires two equal and opposite reactions, involving ions and electrons, that occur simultaneously. The two reactions are called anodic and cathodic reactions, respectively. The process also requires an electrolyte in which the reactions will take place, in this instance, the electrolyte is the concrete. The anodic reaction is an oxidation reaction, in which the valence becomes more positive as electrons are released. The cathodic reaction is a reduction reaction, in which the valence becomes more negative as electrons are consumed.¹

Chloride ions coming into contact with the reinforcing steel in concrete lead to the formation of anodic areas. Nearby non-corroding areas of the steel act as cathodes. Corrosion takes place at the anode where a typical reaction for steel is:

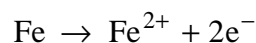

Electrons are produced in this reaction and the iron ion goes into solution.

At the cathode, a typical reaction is:

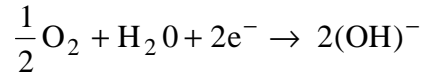

Electrons generated by the anodic reaction are consumed in this reaction. The OH^- ions produced in the cathodic reaction will react with the iron ion produced in the anodic reaction to form corrosion products.

A schematic representation of the corrosion process for a single steel bar in concrete is shown in Figure 1.1.

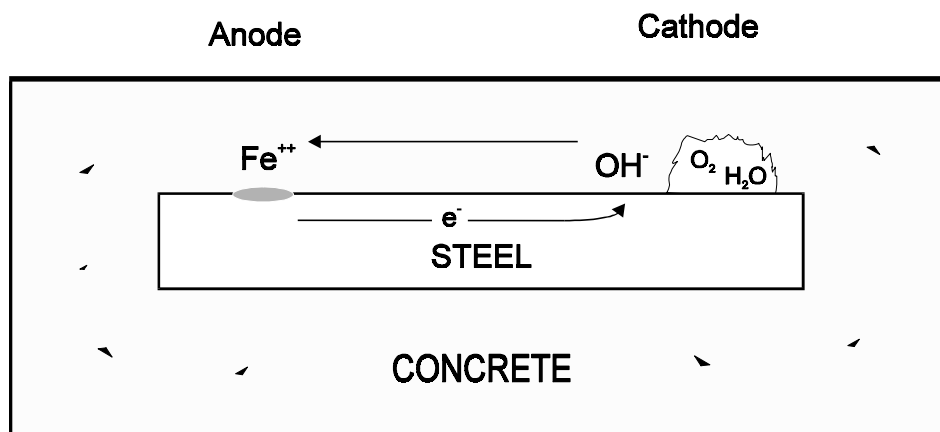
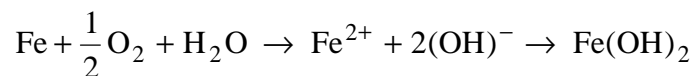

Figure 1.1 Corrosion cell in reinforced concrete

In an actual reinforced concrete structure, reinforcing bars in one area may act as the anode in a corrosion reaction while bars elsewhere serve as the cathode.

The overall chemical reaction that occurs for corrosion of steel in concrete is as follows:



The iron hydroxide that forms is insoluble, and subsequently builds up to form the reddish product commonly known as rust. This rust takes up more space than the original non-corroded steel, resulting in the creation of expansive forces within the concrete. The relatively weak tensile strength of the concrete is not enough to restrain the level of induced stresses, and hence concrete cracking and spalling results. The new cracks in the concrete allow more chloride ions to penetrate, aggravating the existing corrosion problem.

1.3 Epoxy-Coated Reinforcement

In the search for an effective method to cope with the corrosion of steel in concrete, the use of reinforcing bars covered with a barrier type coating emerged as a promising solution. Fusion bonded-epoxy-coated reinforcement is designed to resist corrosion when concrete cracking permits chlorides to reach the steel. The epoxy is usually a bisphenol-amine formulation deposited as a powder on the heated bars at a temperature near 400°F.² The epoxy cures on the surface of the reinforcement, forming a protective layer over the bar.

Epoxy-coated reinforcing steels have been in use since the mid 1970's, and their performance on several highway projects has been good. Compared to black (uncoated) reinforcing bars, the epoxy-coated steels have shown less corrosion, and, subsequently, less corrosion related damage. However, it has been shown in laboratory tests and field studies that epoxy coatings will not completely stop the process of corrosion. In fact, reports on bridges with epoxy-coated reinforcement in the Florida Keys have reported that the coated steels performed as poorly as uncoated bars and that the presence of the coating was not helpful in resisting corrosion.³ It is apparent that more research is required to understand under what circumstances and conditions epoxy-coated reinforcement serves as a positive aid in the prevention of corrosion.

1.3.1 DAMAGE TO EPOXY-COATED REINFORCING BARS

One aspect of epoxy-coated reinforcement that has been shown to be critical in determining how well it will perform is the number of defects in the coating. In previous testing at the University of Texas, the level of damage to the coating has been shown to govern the resistance to corrosion.⁴ The larger the areas damaged and the percentage of damage on the surface of the bar, the higher the rate of corrosion. Subsequently, an investigation was begun into the damage a typical epoxy-coated reinforcing bar receives during its life: from defects arising from the coating process, to those obtained during handling, storage, and transportation, and finally to defects resulting from fabrication and placing. The results of this investigation are reported in references 4 and 5.

Concrete placement is the last possible procedure during which the coating on reinforcement will be damaged before the rebar is put into service. Any damage during concrete placement cannot be seen nor repaired. Figure 1.2 shows the epoxy-coated reinforcing cage of a precast element bounded by metal formwork, and the same element in the midst of the concrete placement procedure.

During consolidation the steel vibrator head used to consolidate the concrete contacts the coated rebar repeatedly. The head rebounds from the metal walls of the formwork and violently contacts the rebar. Since the extent of coating damage resulting from procedures of this sort was not known, but was likely significant, an initial investigation of damage due to vibration was undertaken.

The initial damage investigation showed that a significant amount of damage was done to the epoxy coating on reinforcing bars during the placement of concrete. When the steel head vibrator used to consolidate the concrete came into contact with the coating, substantial amounts of damage resulted. As a result of this finding, a more detailed study of concrete vibrators used with epoxy coated reinforcing bars was scheduled.

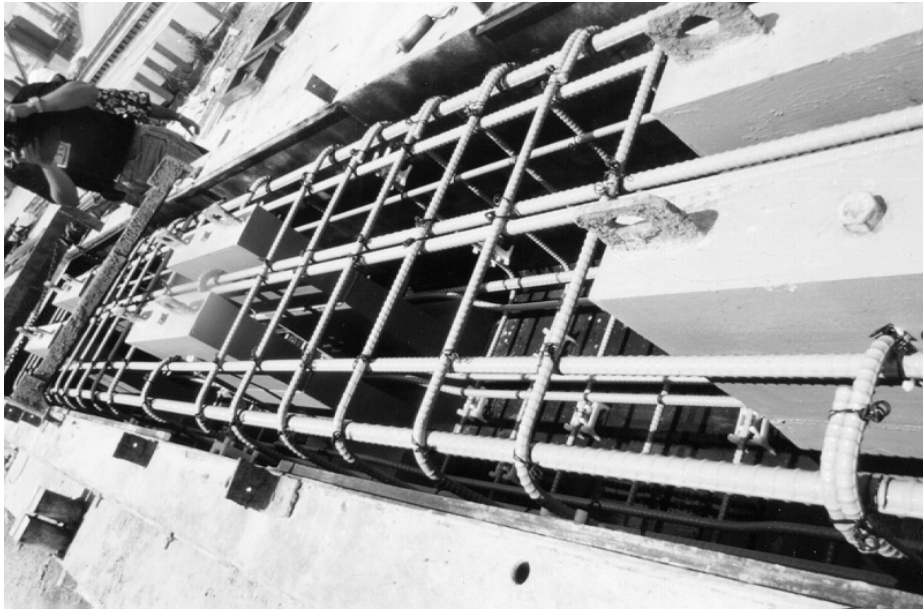

(a) Precast element reinforced with epoxy-coated steel



(b) Vibration of concrete in precast element

Figure 1.2 Concrete placement procedure in precast pier cap

Earlier work on this project showed further that corrosion activity is of great concern at locations where damaged spots are adjacent to voids in the concrete. Wetting and drying of voids, as well as the concentration of oxygen and chlorides in voids, promote corrosion at damaged spots on the coated bars. When a damaged spot is exposed to corrosive agents, the localized area of steel cannot passivate, and the process of corrosion will progress. Especially at larger damaged spots on the bottom of a coated bar where voids are adjacent to the surface, localized corrosion may be extensive. Since the degree and quality of concrete consolidation determine the void content of the concrete, the consolidating ability of concrete vibrators was another factor of great interest in this study. Concrete consolidation, particularly in the area surrounding reinforcement, has been shown to play a significant role in the corrosion performance of coated bars, so the ability of the new rubber vibrator heads to adequately consolidate concrete specimens and remove as many air pockets as possible required investigation.

1.4 Research Objectives

Based on the amount of damage that resulted from the use of steel head vibrators with epoxy-coated reinforcement, it was decided that damage tests be conducted on new “soft” (rubber) head vibrators. Promotional literature for soft head vibrators indicated that they will “not damage epoxy coatings.”⁶ Furthermore, the soft head was reported to be more “effective” than the steel head. Preliminary results of this project had shown that the amount of damage to the epoxy coating and the quality of concrete consolidation, particularly that around the reinforcing bars, were both important factors in determining how well the epoxy-coated reinforcement would perform. Accordingly, the performance of the soft head vibrator with respect to both coating damage and consolidation was examined in the current investigation.

The specific objectives of this testing are as follows:

- 1) Assess the damage introduced to epoxy coated reinforcing bars by metallic head and rubber head vibrators through a visual examination of the bars.
- 2) Assess the quality of consolidation obtained with a rubber head vibrator as compared to a metallic head vibrator based on measurements in fresh concrete during vibration.
- 3) Determine the degree and quality of consolidation obtained with the rubber head vibrator as compared to metallic head vibrator through both a visual examination and density of cores from vibrated specimens.
- 4) Make recommendations on the appropriate type of internal vibrator to be used in conjunction with epoxy-coated reinforcement.

1.5 Review of Concrete Consolidation

Fresh concrete may contain as much as 20% entrapped air after initial placement into the forms. The precise amount of entrapped air will vary with concrete workability and slump, form configuration, amount of reinforcement, and the method of concrete placement.^{7,8} If the concrete is allowed to harden without removing the entrapped air, the concrete will be non-uniform and will have a high permeability. Furthermore, the concrete will be weak and poorly bonded to the reinforcing steel. In order for the concrete to develop acceptable properties and performance in service, the freshly placed concrete must be

consolidated. Consolidation, or compaction, is the process of removing entrapped air from freshly placed concrete. By consolidating the concrete, the entrapped air is driven out and the concrete's permeability is decreased. Better consolidation has also been shown to increase the strength of the bond between the reinforcement and the concrete, and the overall strength of the concrete.⁷ Poor consolidation can lead to frost damage and reinforcement corrosion as aggressive matters, such as water and chlorides, penetrate the concrete.⁹ Thus, achieving well consolidated concrete is important both in limiting negative characteristics, and increasing positive aspects of the concrete's performance.

There are manual and mechanical methods available to consolidate a concrete mixture, but the approach of interest in this report is the use of concrete vibrators. A concrete vibrator delivers a fast oscillatory motion to the fresh concrete. The oscillation is essentially a simple harmonic motion, and is commonly described in terms of a frequency (oscillations or vibrations per unit time) and an amplitude (deviation from point of rest). Acceleration is another useful measure, giving the intensity of vibration in the concrete.⁷

Vibration of concrete involves subjecting the fresh concrete to rapid impulses which liquefy the mortar and reduce internal friction among the concrete's components.^{7,10} As the vibrator moves the particles within its area of influence, the entrapped air bubbles rise to the surface and escape. During vibration, the freshly placed concrete becomes unstable and seeks a denser, lower energy level. Subsequently, the mounds or piles of concrete will flatten out as the concrete flows away from the vibrator and out into the form.

In its liquefied state the concrete can move through the reinforcing cage and into crevices in the formwork. Large void areas are eliminated as the concrete spreads out into the available space. Additionally, while the concrete is flowable, the entrapped air bubbles in the concrete are able to rise to the surface as the liquefied concrete offers less resistance to their escape. The larger air bubbles will escape first, due to their greater buoyancy. Also, the air bubbles nearer to the vibrator will be removed before those on the fringes of the vibrator's area of influence. The de-aeration of the concrete continues as the concrete is vibrated, even after the concrete flattens out.¹¹ If the vibrator is removed from the concrete too quickly, the smaller air bubbles will not have enough time to rise to the surface of the concrete and escape. Vibration should continue until most of the entrapped air is removed from the concrete. The final amount of entrapped air drops from about 20% prior to vibration to 1 to 3% after adequate consolidation.

1.5.1 INTERNAL CONCRETE VIBRATORS

The most common type of concrete vibrator is the internal (spud or poker) vibrator. All internal vibrators used today are of the rotary type, which means the vibrating head follows an orbital path due to the eccentric, or unbalanced, weight in the head of the vibrator. The concrete vibrators used most often are of the flexible shaft type. This vibrator has a vibrating head attached to a flexible shaft, which is powered by an electric or pneumatic motor, or by a portable combustion engine. Figure 1.3 shows a flexible shaft vibrator being used to consolidate concrete in a bridge deck.

In the electric vibrator, the flexible drive shaft leads from the motor to the head of the vibrator where it turns the eccentric weight. The frequency of the vibrator affects the amount of time required to satisfactorily complete the consolidation of the concrete. With an electric vibrator, the frequency is controlled by the voltage of the motor. The frequency should be checked periodically to ensure optimum operating performance of a particular piece of equipment.⁷



Figure 1.3 Consolidation of concrete in bridge deck

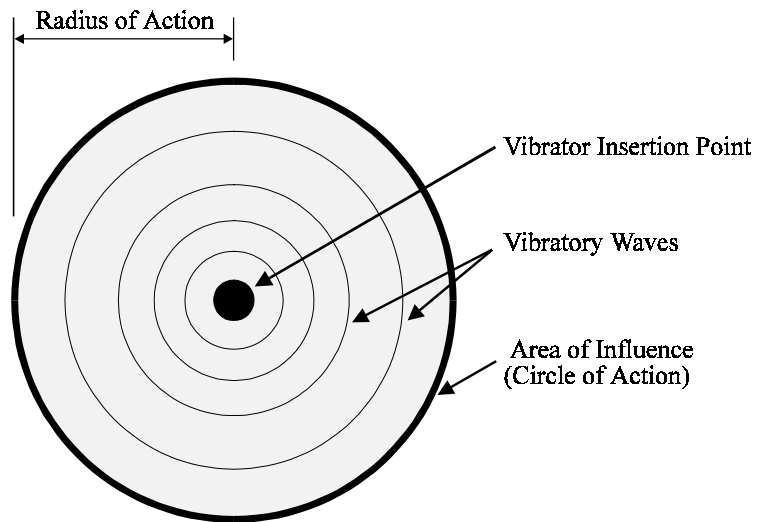

Figure 1.4 Area of influence for concrete vibrator

In the past, the frequencies of concrete vibrators were much lower, requiring extended periods of time to vibrate the concrete. To compact concrete with a ½ in slump takes 90 seconds at 4,000 vibrations per minute (vpm), 45 seconds at 5,000 vpm, and 25 seconds at 6,000 vpm. But with a modern vibrator having a frequency of 15,000 it takes only 5 to 15 seconds of vibration time to adequately consolidate the concrete. Internal vibrators in common use today have a frequency between 12,000 vpm and 17,000 vpm in air. This frequency is reduced by about 20% when the vibrator is immersed in concrete.⁷

When an internal vibrator is inserted in fresh concrete, a definite area of concrete around the point of insertion is affected. The zone of concrete around the head that is adequately consolidated during vibration is called the area of influence of the vibrator, as shown in Figure 1.4. The area of influence is also referred to as the area of action, or circle of action. The radius of action of a vibrator is the distance from the vibrator head within which the concrete is consolidated.⁸

The radius of action of a vibrator is affected by the amplitude, frequency, and head size of the vibrator, as well as properties of the concrete, such as its slump and mix proportions.^{7,12} A specific vibrator's reported radius of action is an approximate guideline, but the actual radius of action in a specific batch of concrete will be affected by the resistance of that concrete to movement and its mix proportions, as well as the way in which the reinforcement is laid out.

1.5.2 CONCRETE PLACEMENT PROCEDURE

During concrete placement, the concrete should be placed in layers, as close as possible to its final position in the form. The depth of each layer should be limited to ensure that it can be properly consolidated. The Texas Department of Transportation Standard Specifications for Construction of Highways, Streets and Bridges requires that each layer of concrete be less than 0.9 m (36") in depth.¹³ The ACI Guide for Consolidation of Concrete suggests a more stringent limitation of 500 mm (20") as the maximum layer depth.⁷ In general, the layer depth should be nearly equal to the length of the vibrator head. The concrete layers should be as level as possible to minimize lateral movement of the concrete, as this may lead to segregation. Minor leveling of the concrete can be accomplished by placing the vibrator in the center of high spots to flatten them out.

In a proper vibration procedure, the vibrator is inserted vertically in the concrete at regularly spaced intervals. The distance between points of insertion should be about 1½ times the radius of action of the vibrator, so that the area of influence of adjacent areas overlap several centimeters (a few inches) as shown in Figure 1.5. The overlapping of the areas of influence ensure that all of the concrete, including the area adjacent to the form, is vibrated.⁷

As discussed, the concrete should be placed in layers into the formwork. If placement is proceeding properly, the vibrator should penetrate quickly to the bottom of the layer and at least 6" into the layer below. The vibrator is moved up and down for 5 to 15 seconds to vibrate the freshly placed concrete, and to blend the new concrete with underlying layers. The down motion of the vibrator should be a rapid drop into the concrete to apply force to the concrete and release internal pressure. The vibrator will initially flatten out any mounds of concrete and liquefy the concrete. Continued vibration will allow the entrapped air bubbles to escape, see Figure 1.6. The larger air bubbles will escape first, due to their greater buoyancy. Also, the air bubbles nearer to the vibrator will be removed before those on the fringes of the vibrator's area of influence.⁷

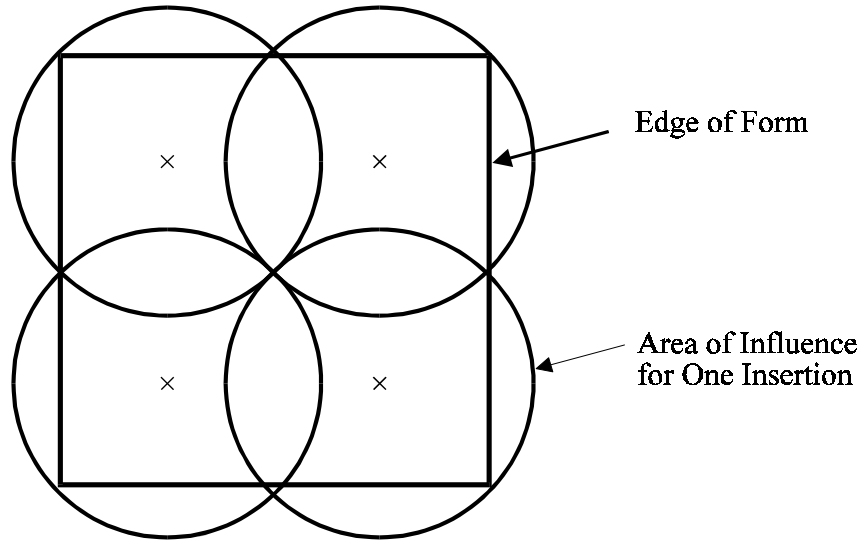

Figure 1.5 *Overlap of areas of influence*

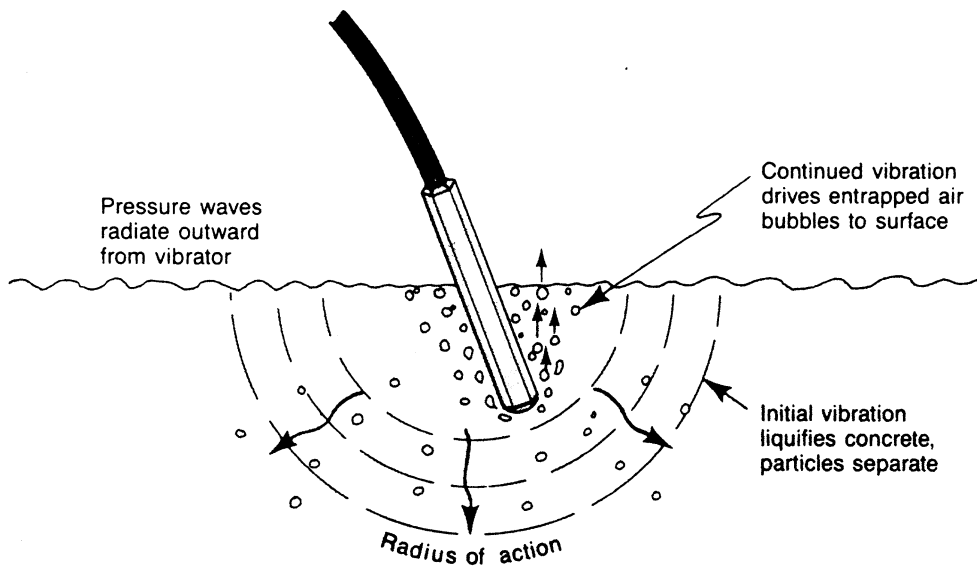

Figure 1.6 *Action of internal vibrator⁸*

After the concrete has been vibrated sufficiently, the vibrator should be removed gradually in a series of up and down motions. When the head is only partly immersed in the concrete, it should be quickly extracted to avoid segregation at the surface. The concrete should flow back into the open space left by the head, but in a stiff mix the hole may not completely close after withdrawal of the vibrator. If this is the case, inserting the vibrator several centimeters (a few inches) away from the hole will likely solve the problem. If this procedure does not eliminate the hole, the mix design and/or vibrator should be changed.⁷

1.5.3 UNDER-VIBRATION VERSUS OVER-VIBRATION

A key point in the use of a concrete vibrator is vibrating the concrete long enough to ensure that it is adequately consolidated. Inexperienced vibrator operators tend to under-vibrate concrete.^{7,14} They vibrate long enough to flatten the concrete out, but not long enough to de-aerate the concrete. Furthermore, efforts to keep up with the pace of concrete placement can result in an operator moving quickly and not allowing enough time for the entrapped air to be removed from the concrete.

The operator can determine when the concrete has been vibrated sufficiently by watching the surface of the concrete. After the initial flattening of the concrete, large air bubbles can be seen escaping from the surface of the concrete. This escape of air bubbles will continue as the operator keeps vibrating the concrete. After the coarse aggregate has been embedded and a thin film of mortar develops on the top surface, and when no more large air bubbles rise to the surface, the concrete has been adequately consolidated. Another aid experienced operators use in judging when the concrete has been satisfactorily vibrated is the pitch or tone of the vibrator's motor. When the immersion vibrator is initially inserted in the concrete, the frequency will momentarily drop, then increase, reaching a constant frequency when the concrete has been freed of entrapped air.⁷

Under-vibration is a far more common occurrence than is over-vibration. A well designed concrete mix is not susceptible to over-vibration, so when the quality of consolidation is in doubt, the concrete should be vibrated more. If the mix is not well designed and if it is over-vibrated, the concrete may segregate and excessive amounts of entrained air may be lost. But, over-vibration should not be of concern unless the mix has a high slump and is improperly proportioned, or if the vibrating equipment is grossly oversized or recklessly operated. But, in the absence of this sort of negligence, over-vibration should not be a problem.⁷

1.5.4 DESIGNING FOR CONCRETE PLACEMENT

Consideration should be given to the ease with which concrete can be placed in an element when the formwork and reinforcement of the member is detailed. For example, to ensure adequate consolidation is possible with an internal vibrator, obstruction free vertical access with a 4 in x 6 in minimum opening should be available. Furthermore these openings should be spaced less than 24 in, roughly 1 1/2 times the radius of action of an internal vibrator.¹¹ Attention should be given to factors that affect the placement and consolidation of concrete from the point of view of the constructor. The member size, and bar size, location, and spacing should be critiqued based on ease of concrete consolidation. Problem areas should be recognized by the designer and appropriate modifications made, such as staggering splices, modifying spacing, or grouping bars to assist the constructor in obtaining adequate consolidation. If conditions seem to indicate the consolidation will be inadequate it may be necessary to redesign a

member or its steel, modify the concrete mix, conduct a consolidation test, or alert the constructor that special care must be given to ensure the member is adequately consolidated.^{7,9}

In the design of a concrete mixture, consideration should also be given to the placement conditions. It should be possible to readily work the concrete into form corners and around reinforcement without segregation or excessive bleeding. If thorough vibration is not possible in an area due to crowded reinforcement or other obstructions, it may be advantageous to increase the slump with admixtures to produce a flowable mix that can be consolidated under the congested conditions. Additionally, the use of form vibration may be effective in supplementing the consolidation in areas where internal vibration cannot, or should not, be used.

When the concrete is not effectively vibrated, imperfections will likely result. As presented in the Guide to Consolidation, the most serious imperfections are honeycombs, excessive entrapped air voids or bugholes, sand streaks, subsidence cracking, and pour lines. In this research, the presence of excessive entrapped air voids, especially air voids beneath reinforcing bars, is of particular interest.

The amount of entrapped air after vibration is affected by the vibrator equipment and procedure, the concrete mix constituents, properties of the mix, configuration of the form and reinforcement, as well as other factors. To reduce air voids in the concrete, the distance between vibration insertions should be reduced, and the amount of time at each insertion point should be increased. In some situations, it may also be advantageous to use a more powerful vibrator.

1.5.5 SELECTING AN INTERNAL VIBRATOR

Choosing a vibrator that can effectively consolidate concrete is the main requirement, but there are also other features that should be considered. First, the vibrator chosen should have an adequate radius of action and should be able to quickly consolidate the concrete. Additionally, the vibrator should be reliable, relatively lightweight, easy to use, and resistant to wear. Some of these features are mutually exclusive, so it is necessary to compromise to a certain extent. The need for compromise on desirable features becomes even greater when the use of a rubber head vibrator is considered.

The steel head of the typical internal vibrator is very hard and is not easily worn down by the concrete, formwork, and reinforcement it comes in contact with during use. The rubber of the soft head vibrator, however, is obviously a softer material, that is more readily worn by use. Subsequently, the rubber head will need to be replaced more often than a steel head would. It is not reasonable, however, to think of greatly increasing the rigidity of the soft head, as it is its soft nature that makes it less damaging to epoxy-coated reinforcement.¹⁵ The increased wear rate of the head is a tradeoff that must be made to protect the coating of the reinforcement.

1.6 Organization of Research

A literature review and field visits were conducted to gather information for this study. The phenomenon of corrosion in reinforced concrete was reviewed, as were past studies on the performance of epoxy-coated reinforcement. Of specific interest in this review were indications of the amount and significance of the level of damage to the epoxy coating of the reinforcement.

Through consultation with the sponsors of this project, appropriate test sections were chosen and damage to coating due to concrete placement with rubber and steel vibrators was evaluated. Consolidation with the two vibrators was assessed in both fresh and hardened concrete. A summary of the study, conclusions, and recommendations are presented.

CHAPTER TWO

EVALUATION OF EPOXY COATING DAMAGE DURING CONCRETE PLACEMENT

2.1 General

As discussed in the introduction to this report, vibration is used in the placement of concrete to reduce the amount of entrapped air and to consolidate the concrete in the forms and around the reinforcement. Internal or immersion vibrators are widely used in construction. The head of the vibrator imparts energy to the concrete, and the concrete momentarily “liquefies” and flows out into the formwork. In its flowable state, the concrete offers less resistance to the escape of entrapped air, and subsequently large air bubbles rise to the surface as the concrete is vibrated. This process consolidates or densifies the concrete, with the aim of producing good quality, relatively impermeable concrete.

During the placement and vibration of concrete, the aggregate particles and vibrator head will, inevitably, come in contact with the epoxy-coated reinforcement. Subsequently, damage to the coating will occur. This damage, unlike that from transportation and handling, cannot be inspected or repaired and may cause the coating on the reinforcement to perform poorly. In particular, extensive damage to the coating close to the concrete surface, or damage spots adjacent to voids in the concrete, may serve as sites for initiation of corrosion in the concrete.

In an earlier study in this project, the damage that resulted when a typical steel head concrete vibrator was used to consolidate several concrete specimens was investigated. Significant damage resulting from the placement operation was observed. Subsequently an investigation of new “soft” rubber head vibrators was proposed. These rubber head concrete vibrators were advertised as doing no damage to the epoxy coating during concrete placement, and therefore were reported to be superior to the metal head vibrators normally used in construction. In this chapter, an experimental study conducted to evaluate the degree of damage caused by concrete placement with both steel and rubber head internal concrete vibrators is summarized. Recommendations on vibrator use with coated reinforcement are presented.

2.2 Damage to Coating Prior to Placement of Concrete

The last occasion for the coating on steel reinforcement to be damaged is during the concrete placement procedure. Sometimes the level of damage just prior to concrete placement is given as the condition of the in-place epoxy-coated bar, but this neglects the last possible opportunity for damage. Damage resulting during placement adds to any existing damage, producing the true damage condition for the coated reinforcement.

The damaged condition of a coated bar is expressed as a percentage measurement. The area of damaged coating in a linear foot is given as a percentage of the total bar surface area in that foot. Thus a damaged area of 1.2 cm^2 (0.19 in^2) in 0.3 m (a foot) of 13 mm (#4) bar would be labeled as 1% damage, since

the surface area of this bar section is 121.6 cm² (18.85 in²). Specifications limit the permissible percentage of damage on projects where epoxy-coated reinforcement is used.

To weigh the amount of damage during concrete placement, with respect to prior damage, it is necessary to establish the amount of damage prior to placement. A previous investigation done through this project located two applicable surveys in this area. Surveys were conducted in Kentucky and Iowa to establish the amount of damage to the coating of reinforcing bars prior to the placement of concrete.⁴ In the Kentucky study, 2.3 m² (25 ft²) areas of 16 bridge decks were inspected. On some of the bridges, several areas were inspected to obtain more data. In this inspection, coated bars that had been prepared with different percentages of damage were used as an aid in cataloguing the damage.

Twelve decks had an average damage between 0.0 and 0.010%, while three others showed average damage between 0.011 and 0.04%. The worst damaged area on a particular deck was 0.4%. When one looks at these results it should be remembered that field inspections of epoxy coating damage are difficult to perform and these results cannot be viewed as precise. The biggest problem in these field inspections is detecting damage on the undersides of bars. Therefore it is likely that the actual damage percentage on these decks is greater than reported.

In the Iowa study, 36 bars were randomly chosen from a construction site immediately prior to their installation as column reinforcement. The damage estimation in this study was based on area representation cards. Each damaged area on the bars was compared to 18 shaded rectangles ranging in area from 2.5 to 60.6 mm² (0.0039 to 0.094 in²). The maximum percentage of damage in any 0.3 m (1 ft) length was 1.08% of the surface area for the 48 mm (#15) bars and 0.88% for the 35 mm (#11) bars.

These surveys, and others, show that the amount of damage prior to placement of concrete varies considerably. The level of damage can be minimal, if adequate care is taken during production, transportation and handling, and construction stages. However, when improper procedures occur during any of these stages the amount of damage may be significantly increased. At one time, it was assumed that good practices would result in negligible levels of coating damage, on the order of 0.1%. However, recent inspection of substructures in the Florida Keys have shown that 1% may be a more reasonable approximation of coating damage before concrete placement.³

2.3 Evaluation Tests of Coating Damage During Concrete Placement

2.3.1 TEST SPECIMENS

The purpose of the tests conducted in this portion of the study was to examine and compare the damage produced during placement of concrete with steel and rubber head concrete vibrators. Three types of test specimens were constructed, representing sections of various reinforced concrete elements. These elements were a column or bridge pier, a footing, and a deck slab. Two identical forms and reinforcement cages were constructed for each type of specimen - one for use with the metal head vibrator, and the other for the rubber head vibrator. All reinforcement in the test specimens was epoxy-coated and had a parallel rib, or bamboo, deformation pattern. The mix proportions of the concrete used in each test are presented in the Appendix.

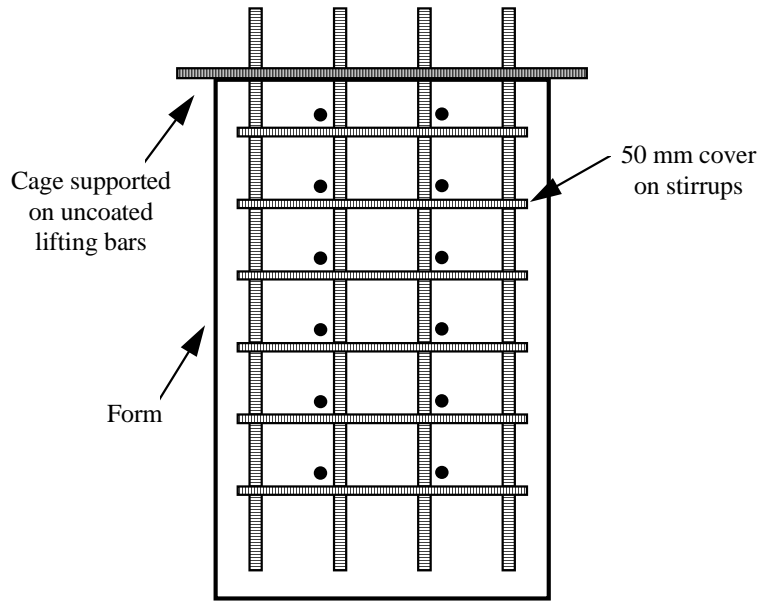

Figure 2.1 Details of column specimen

2.3.1.1 Column Specimens

The first pair of test specimens modeled a column or bridge pier. Duplicate specimens were prepared. The vertical reinforcement in the columns consisted of 36 mm (#11 bars) at 20 cm (8 in) spacing, and the stirrups were 13 mm (#4) bars, spaced at 18 cm (7 in). Additional straight segments of #4 bars were included to simulate cross ties in the column. Figure 2.1 shows the details of the column and Figure 2.2 shows the layout of the reinforcement in the test specimens. Black bars, used to lift the cage from the concrete after the vibration test, were welded near the top of the cage as shown in Figure 2.1. The epoxy-coated reinforcement was

carefully examined and the damage prior to placement of concrete was marked. The reinforcing cages were tied with plastic coated tie wire to minimize assembly damage.

2.3.1.2 Footing Specimens

The second pair of test specimens modeled a bridge footing. These specimens were each reinforced with two mats of coated bars. The top mat of reinforcement in each specimen consisted of 13 mm (#4) bars spaced at 15 cm (6 in). The lower mat was made up of 19 mm (#6) bars spaced at 28 cm (11 in). Figure 2.3 shows the position of the reinforcing mats in the form, and Figure 2.4 gives the layout and arrangement of the bars. All reinforcing bars in these specimens were epoxy-coated, and all damage existing prior to the vibration test was located and marked. Ropes were attached to both the upper and lower reinforcing mats in each specimen during construction. These ropes were used to pull the reinforcing mats out of the concrete after the vibration was completed.

2.3.1.3 Deck Specimens

The final set of specimens was constructed to represent sections of typical bridge decks. Figure 2.5 shows the position of the deck mats in the formwork, and the layout of reinforcement in the deck specimens is presented in Figure 2.6. As shown in the figure, half of the test section had a 10 cm (4") depth, while the other half was 20 cm (8") deep. The shallow section of the test specimen modeled conditions where a cast-in-place section with epoxy-coated reinforcement is placed over a precast panel. The deep section of the specimen modeled the casting situation when the bridge deck is fully cast-in-place. All reinforcement in each of the deck specimens was epoxy-coated, and existing damage was marked.

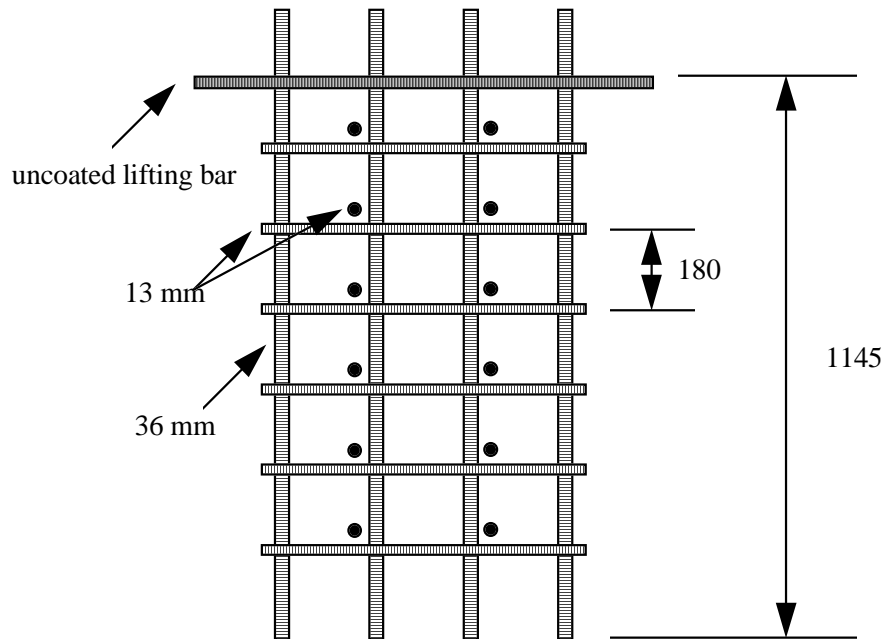

All dimensions are in mm

a) Elevation View

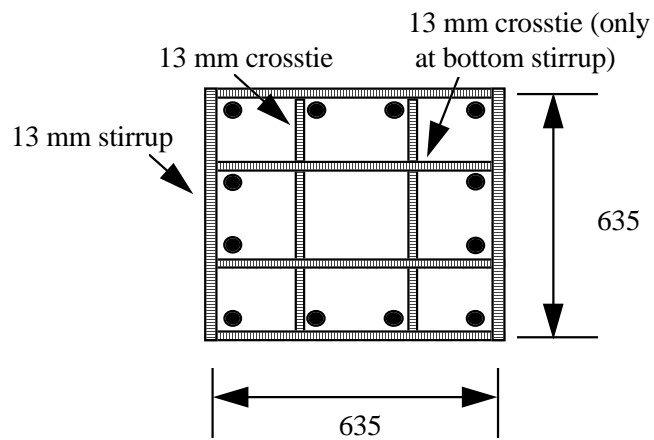

b) Plan View

Figure 2.2 Details of column reinforcement

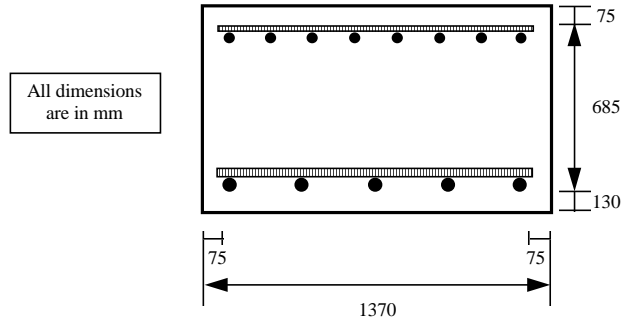
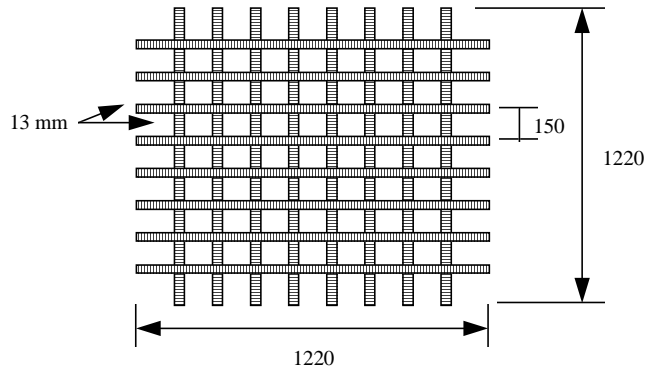
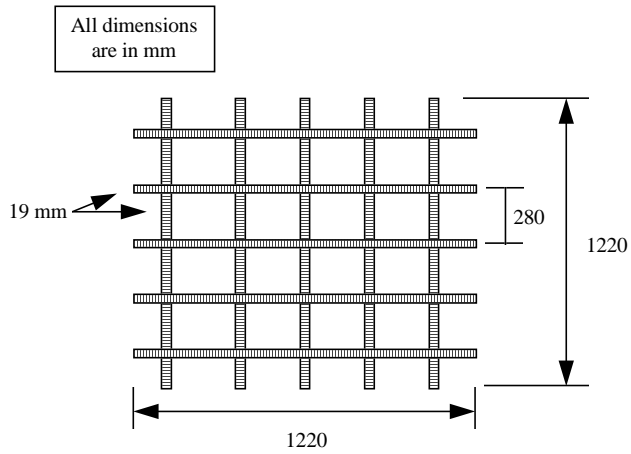

Figure 2.3 Details of footing specimen



a) Upper Reinforcement Mat



b) Lower Reinforcement Mat

Figure 2.4 Details of footing reinforcement

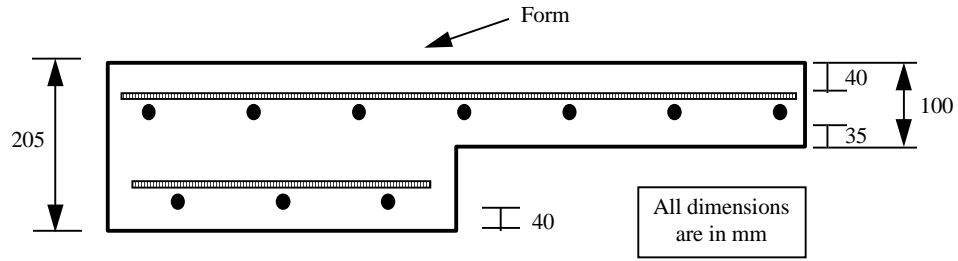
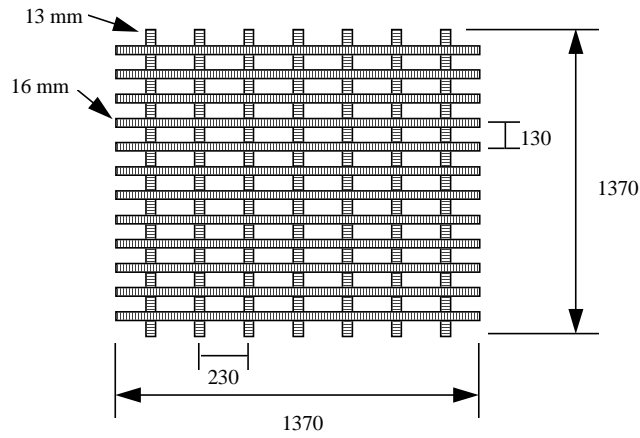
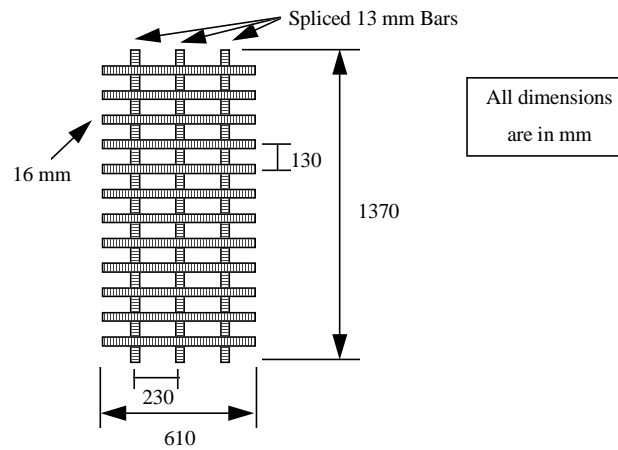

Figure 2.5 Details of deck specimen



a) Upper Mat of Reinforcement



b) Lower Mat of Reinforcement

Figure 2.6 Details of deck reinforcement

2.3.2 TEST PROCEDURE

2.3.2.1 Column Vibration Test

Concrete was placed in the forms directly from the ready-mix truck. Figure 2.7 shows a picture of the concrete placement procedure. The concrete was placed in the form in three equal lifts. A concrete vibrator with a metal head was used to consolidate the first specimen, and one with a rubber head was used to vibrate the second specimen. The metal head used in the column test was 4.4 cm (1 3/4 in) in diameter and 35.5 cm (14 in) in length. The rubber head was 4.8 cm (1 7/8 in) in diameter and 35.5 cm (14 in) in length. The same model of concrete vibrator with an electric 17 amp motor was used in each test. Flexible shafts from the same manufacturer, each 2.1 m (7 ft) in length, were used in the two tests.



Figure 2.7 Placing concrete in column form

The vibrator was inserted at sixteen points in each lift. A picture of the metal head specimen during vibration is shown in Figure 2.8. During each test, the head of the vibrator was purposely inserted between the formwork and the stirrup at eight locations to simulate the damage that results when the vibrating head is forced to operate in a very confined area. At each insertion point the concrete was vibrated for 4-5 seconds. The same operator consolidated the concrete with both the metal and rubber head vibrators to eliminate differences that might occur between operators. The same procedure and schedule of insertion points was followed with each type of vibrator head.

After vibration, before the concrete reached initial set, the reinforcing cages were pulled from each form. The cages were lifted using the special bars shown in Figure 2.2. A picture of the lifting operation is presented in Figure 2.9. After the cages were removed from the concrete they were carefully washed, as shown in Figure 2.10, to remove all concrete from the bars before it hardened. The coating on the reinforcement in the two cages was carefully inspected after the test and the damaged induced with each head was catalogued.

2.3.2.2 Footing Vibration Test

Concrete was placed in each footing form directly from the ready-mix truck, as shown in Figure 2.11. The concrete was placed in three equal lifts and the vibrator was inserted at sixteen points in each lift. A concrete vibrator with a metal head was used to consolidate the first specimen, and one with



Figure 2.8 Consolidating column specimen



Figure 2.9 Lifting column reinforcement cage from concrete

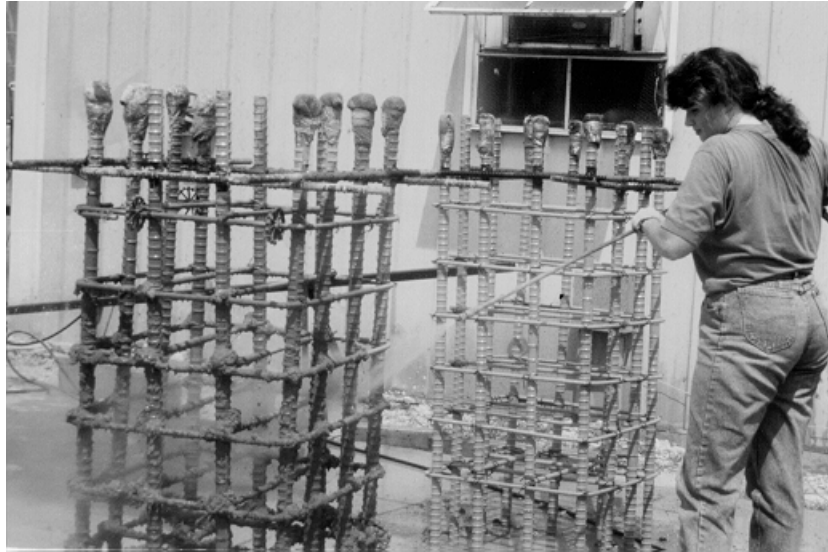

Figure 2. 10 Washing column cages after vibration



Figure 2. 11 Placing concrete in footing form



Figure 2.12 Consolidating footing specimen



Figure 2.13 Lifting footing reinforcement mat from concrete

a rubber head was used to vibrate the second specimen. Figure 2.12 shows a picture of the rubber head specimen during consolidation. The metal head used in the footing test was 4.4 cm (1 3/4 in) in diameter and the rubber head was 4.8 cm (1 7/8 in) in diameter. Both heads were 35.5 cm (14 in) in length. The concrete was vibrated for 4-5 seconds at each insertion point. The same operator conducted the test of each type of vibrator head, and the same procedure was followed with each of the heads.

After vibration was completed, all reinforcing mats were pulled from the concrete using the lifting ropes noted in the footing specimen description. Figure 2.13 shows a picture of the lifting operation. The rubber head vibrator was inserted in each form during the lifting operation to make it easier to remove the mats. Upon removal, each reinforcement mat was thoroughly washed with water, as shown in Figure 2.14. After the tests, the damage on each of the mats was inspected and catalogued.

2.3.2.3 Slab Vibration Test

Concrete was placed in the slab forms in one lift directly from the ready-mix truck. The vibrator was inserted at thirty-six points in each slab form and the concrete was vibrated for 4-5 seconds at each insertion point. A picture of the vibration operation is shown in Figure 2.15. The metal head used in the slab test was 4.4 cm (1 3/4 in) in diameter and the rubber head was 7.0 cm (2 3/4 in) in diameter. Both heads were 22.9 cm (9 in) in length. The head of the vibrator was purposely inserted at an angle at several points throughout each form, to closely model typical field vibration procedures. The same operator conducted both of the slab vibration tests and the same procedure was followed with each type of head. After vibration was completed the reinforcement mats were pulled out of the slab forms and washed with water. The coating damage on each mat was subsequently inspected and catalogued.



Figure 2. 14 Washing footing reinforcement mat



Figure 2. 15 Consolidating slab specimen

2.4 Test Results

2.4.1 GENERAL OBSERVATIONS

Most of the damage from concrete placement appeared to have been caused by abrasion between the vibrator head and the reinforcing bars. Bars located close to the edge of the form, where the vibrating head was most tightly confined, were subject to the largest amount of damage. Abrasion of the coating was seen with both the rubber and metal vibrator heads, but the severity of the abrasions was worse with the metal head.

Some roughening of the epoxy coating was seen, particularly in the column specimens, from contact with the concrete. Two sources probably contributed to this damage. First, some abrasion was caused as the concrete was placed into the form and rubbed the surface of the bars. Second, during vibration the aggregate particles are forcefully propelled away from the vibrating head. These particles likely mar the coating of the reinforcement as they come into contact with it.

Damage was also seen at several locations where reinforcing bars were in contact with each other. Particularly in the column specimens, where the stirrup was in contact with the vertical reinforcement, there were often large damage spots on both the stirrup and the vertical bar. This sort of contact damage was seen in specimens consolidated with both metal and rubber head vibrators.

2.4.2 COLUMN SPECIMENS

Damage caused by each vibrator during the concrete placement operation seemed to have resulted from abrasion between the vibrator head and the coated reinforcement. Both the metal and rubber heads abraded the surface of the coating when they came into contact with it. The areas where the head contacted the coating were roughened. Depending on the length of time the head was in contact with the reinforcement, and the degree to which the vibration of the head was constrained, the condition of the coating ranged from slightly roughened to severely abraded. Under severe conditions, the coating was completely removed from areas of the bar. Typically, only the coating on the ribs was removed, especially on the smaller diameter bars. However, there were areas where the metal head removed the coating from the ribs and from the area between the ribs.

As previously discussed, the damaged condition of a coated bar is expressed by a percentage measurement. The area of damaged coating in a linear foot is given as a percentage of the total bar surface area in that foot. In the damage inspection carried out during this study, each bar section was broken down into 0.3 m (one foot) sections and the percentage of damage in each section was determined. Additionally, the worst percentage of damage in a single foot of each individual bar was evaluated. In all following discussion, the percentages of damaged discussed refer to the percentage of damage in a 0.3 m (1 foot) length of bar.

The total damaged area of coating on bars in the column specimen ranged from 0.01 to 1.9% for the rubber head test specimen, and 0.01 to 6.3% for the metal head test specimen. Figure 2.16 shows a picture of a severely damaged area of produced with the metal vibrator head. For ease of analysis and

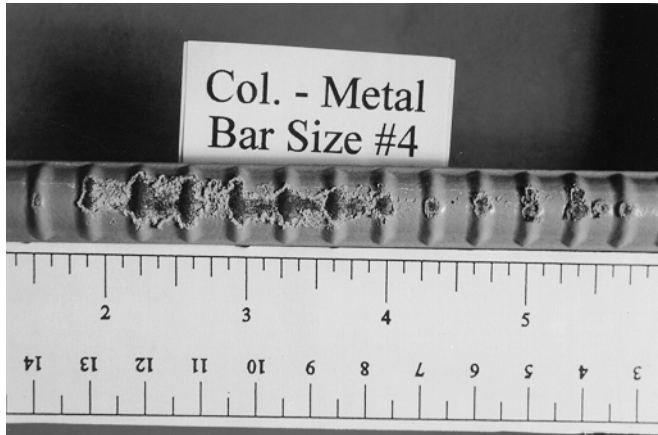

Figure 2.16 Damage to epoxy coating from metal vibrator head

0.052% with the rubber head. The average damage with the metal head was about 20% greater than that with the rubber head. The largest percentage of damage in any 0.3 m (1 ft) length was 0.21% for the metal and 0.16% for the rubber head. With the metal vibrator head, the largest single damage spot was 6 x 13 mm (1/4 x 1/2 in). The largest damage spot was 6 by 6 mm (1/4 x 1/4 in) with the rubber head.

The damage on the vertical column bars seemed to have been caused more by contact between the stirrup and the vertical bars than by direct contact between the vibrator head and the vertical bar. The side of the vertical bars facing the interior of the column cage was generally damage free. There were a few small knicks that seemed to have been caused by cursory contact with the head, but since there was no constraint forcing the head of the vibrator to remain in contact with the rebar, it seemed to have deflected from the bar before doing significant damage. It is quite impossible, in fact, to even purposely force the head to remain in contact with the vertical bar, especially as the operator continues to move the head in the up and down vibrating motion. The head seemed to gravitate away from the solid obstruction of the vertical reinforcement, and did no significant damage through the momentary contact it did make. There was more, albeit relatively minor, damage on the sides of the vertical reinforcement facing the forms.

The outer side of the vertical bars was in contact with the stirrups encircling the reinforcing cage. This contact with the stirrups seemed to be the greatest source of damage for the vertical reinforcement. At many locations, the stirrups were tightly pressed against the vertical bars. Subsequently, when the vibrator head was inserted between the edge of the cage and the form, and the stirrups were violently shaken, damage was produced on the vertical bars. The stirrups rubbed against the vertical bars, removing coating from both the stirrup and the vertical reinforcement. Damage was also produced at a few locations where the end of the head seemed to momentarily wedge between the stirrup and the vertical bar. For the most part, though, the damage resulting from such contact was small and localized. Again, as on the interior of the cage, the vibrator head contacted the vertical reinforcement less often than the horizontal, and the resulting percentage of damage was small.

A final point concerning the vertical reinforcement is the impact of bar size on the percentage of reported damage. Though there were several significant damage spots on the bars on the order of 6 x 6 mm (1/4 x 1/4 in) with each head type, compared to the large surface area of the vertical bars these spots were

comparison, the bars in the reinforcing cages were divided into three types: vertical bars, stirrups, and cross ties. The amount of damage produced on each bar type with the two different vibrator heads was assessed, and comparisons between the two heads were made. In general, the difference between the rubber head and metal head vibrators was more noticeable, and significant, on stirrups and cross-ties than on vertical bars.

2.4.2.1 Vertical Bars

In general, with both the metal and rubber vibrator heads, the amount of damage to the vertical bars in the cages was relatively insignificant. The average amount of damage was only 0.064% with the metal head and

relatively minor. Thus, the same size of damage spot was much more significant on the 13 mm (#4) than on the 36 mm (#11) vertical bar. The size of the bars, in addition to those factors mentioned earlier, resulted in the production of relatively insignificant amounts of damage to the vertical bars with both the metal and rubber head.

2.4.2.2 Stirrups

The next group of bars examined was the stirrups. Again, the metal head produced more damage than did the rubber head. The percentage of damage for the stirrups was much more significant than for the vertical bars. The average percentage damage for all sections of stirrup examined was 0.96% with the metal head and 0.30% with the rubber head. Comparing these percentages shows that the metal head did over three times as much damage as the rubber head vibrator did. A further comparison can be made by looking at the percentage of damage produced on the stirrups where the vibrator head was inserted between the stirrup and the form. The average percentage of damage on these stirrups was 1.49% with the metal head and 0.43% with the rubber. Again, the metal head did over three times as much damage as the rubber head. Comparing the single worse side for the stirrups, there was 2.58% damage with the metal head and 0.43% with the rubber. In this instance the metal head did over five times as much damage as the rubber head.

The maximum size of damaged area produced with the metal head was 6 x 38 mm ($1/4 \times 1\ 1/2$ in) in size. The largest single damage spot with the rubber head was 6 x 13 mm ($1/2 \times 1/4$ in). In addition to producing the largest damage spot, the metal head also produced more large damage spots on the stirrups than did the rubber head. Only one large 6 x 13 mm ($1/4 \times 1/2$ in) and one 6 x 6 mm ($1/4 \times 1/4$ in) spot were produced with the rubber head. The rest of the rubber head damage spots were smaller in size. The metal head, however, produced many large damage spots. There was the one 6 x 38 mm ($1/4 \times 1\ 1/2$ in) spot and a 6 x 13 mm ($1/4 \times 1/2$ in) spot, and also many 6 x 6 mm ($1/4 \times 1/4$ in) spots. The metal head thus not only produced greater percentages of damage, the size of individual damage spots was on average greater than that produced with the rubber head.

2.4.2.3 Cross Ties

Damage in the final bar group, the ones simulating cross ties in the column, again was worse with the metal than with the rubber vibrator head. The average percent damage was 0.64% with the metal head, almost five times the 0.13% damage with the rubber head. Comparing damage on only the 13 mm (#4) bars, there was 0.66% with the metal and 0.12% with the rubber. For the 16 mm (#5) bars, there was 0.59% damage with the metal and 0.15% with the rubber.

The largest damage spot produced by the metal head on the cross ties was a spot 6 x 13 mm ($1/4 \times 1/2$ in). The largest damage area with the rubber head was 6 x 6 mm ($1/4 \times 1/4$ in). As with the stirrups, the metal vibrator head produced more and larger damage spots than did the rubber head.

2.4.3 FOOTING SPECIMENS

Damage to the coating in the footing specimens seems to have been caused by abrasion between the vibrator head and the reinforcement. Damage occurred at random locations where the vibrator head struck the coated bars. Much of the damage was simply abrasion of the surface, without exposing large areas of the steel surface. There were locations, however, where both vibrator heads removed coating

from the surface of the steel. The most damage occurred at centrally located interior bars with both the rubber and metal vibrator heads.

In addition to the damage done through direct contact between a vibrator head and the coating, there was also damage that resulted from bar to bar contact. There were numerous locations where the coating on the reinforcement was damaged where a bar contacted another bar in the reinforcing mat.

Comparing the upper reinforcing mats, with the 13 mm (#4) bars, there was an average of 0.19% damage with the metal head, and 0.14% with the rubber head. For the 19 mm (#6) mats, the metal head produced an average of 0.48% damage, while the rubber head did only 0.17% damage. The largest damage spot on the upper reinforcing mat was 3 x 3 mm (1/8 x 1/8 in) with both the metal and rubber vibrator heads. The largest damage spot on the lower mat was 6 x 13 mm (1/4 x 1/2 in) with the metal head, and 3 x 3 mm (1/8 x 1/8 in) with the rubber head. Thus, based on both the percentage of damage and size of individual damaged areas, there was relatively little difference between the two heads for the upper mat with the 13 mm (#4) bars, but more appreciable differences between the damage results for the lower mat with the 19 mm (#6) bars.

A further comparison that can be made of the lower reinforcement mat was the single worst damaged 0.3 m (1 ft) of bar with each type of vibrator head. With the metal head, there was one bar that had 2.0% damage due to vibration. The worst case with the rubber head had only 0.38% damage, less than one-fifth of that done with the metal head. Thus on the lower mat, the metal vibrator head produced worse damage based on the overall percentage of damage, the size of damaged spots, and the single worst damaged 0.3 m (1 ft) length.

The location of damage on the bars in the footing specimen seemed to vary with the location of the bar. The damage on edge bars in the upper reinforcing mat was located mainly on the sides of the reinforcing bars, with little damage on the top of the bars. Bars located near the interior of the mat, though, had more damaged areas on their top surface. There were also more damaged areas from vibrator contact on the bottom surface of interior bars than on exterior bars. These differences probably can be attributed to the vibration procedure near the edge of the form, versus that at the interior area. At the edge of the form, the operator was very close to the insertion point, and the head of the vibrator could be inserted vertically, or very nearly so. Nearer the center of the form, however, the operator had to reach out to insert the vibrator, and subsequently the vibrator tended to be at more of an angle upon insertion. The angle of the head made it more likely the top of the bar would be contacted on insertion of the vibrator head. Similarly on removal of the head, there was greater opportunity for contact with the bottom of interior bars. Thus, more damage occurred on the tops and bottoms of the interior bars.

For both heads, the bottom mat underwent more damage than did the upper mat. There was relatively little difference between the damage on the 13 mm (#4) mats between the two types of vibrator head, but the amount of damage produced with the metal head on the 19 mm (#6) mat was almost three times that produced with the rubber head. Based on both the percentage of damage and size of individual damaged areas, there was relatively little difference between the two heads for the upper mat with the 13 mm (#4) bars, with more appreciable differences between the damage readings for the lower mat.

As noted, with both vibrator heads, there was more damage on lower mats than upper mats. This occurrence is possibly due to the fact that the test specimens were relatively deep, and subsequently when the vibrator head was immersed into the concrete to consolidate concrete in the vicinity of the lower mat,

the vibrator operator had less control over the action of the head than when the concrete near the upper mat was vibrated.

2.4.4 SLAB SPECIMENS

Damage to the epoxy-coated reinforcement in the slab specimens seemed to come from two main sources. First, from abrasion of the vibrator heads against the reinforcement, and second, rubbing between places where reinforcing bars crossed each other. Damage spots were distributed over various locations on both the upper and lower reinforcement mats. Greater amounts of damage were seen on the upper mat than on the lower mat.

The fact that the lower mat received less damage than the upper mat, in contrast to the results in the footing specimen, can probably best be attributed to the shallow depth of the deck member. Since the two reinforcing mats of the deck were so close together, the upper mat provided a significant degree of protection to the mat below it. Particularly, when the vibrator head was dragged through the specimen, the upper mat received most, if not all, of the abuse.

The average percentage of damage on the upper mat was 0.51% with the metal head, over two and a half times the 0.20% damage with the rubber head. The largest single damage spot with the metal head was 6 x 13 mm (1/4 x 1/2 in), and the largest spot with the rubber head was 6 x 6 mm (1/4 x 1/4 in). However, most of the damage spots on the slabs produced with each of the heads were of smaller size, on the order of 2 x 2 mm (1/16 x 1/16 in). The vibrator heads were purposely inserted at an angle at some locations in the slab and were dragged over the reinforcement. However, the heads were only in contact at any one location for 4-5 seconds. If the heads were allowed to remain on the rebars for longer periods, larger damage spots would have been more common, but under the testing conditions smaller size damaged areas were produced.

The bars in the lower reinforcing mat were broken into two types for analysis. These were the spliced sections of 13 mm (# 4) bar and the 0.6 m (2 ft) segments of 16 mm (#5) bar. The spliced bars had an average damage of 0.19% with the metal head, and about half that, 0.10%, with the rubber head. The 16 mm (#5) bars showed average damage of 0.20% with the metal head vibrator, and 0.12% with the rubber head. The largest single damaged spot on the spliced bars was 3 x 3 mm (1/8 x 1/8 in) with both the metal and rubber heads. The largest spot on the 16 mm (#5) bars was 6 x 6 mm (1/4 x 1/4 in) with both the metal and rubber vibrator heads.

As the figures above show, the average amount of damage on the lower slab reinforcement mat was relatively small with both the metal and rubber vibrator heads. The upper mat seemed to help protect the lower mat from damage. The vibrator head contacted reinforcing bars in the upper mat more often than those in the lower mat, especially when the head was inserted at an angle. At several insertion points it seems the head scraped across the upper mat without contacting the lower mat. Furthermore, when the head did penetrate to the lower mat the extent of damage caused was less than that experienced by the upper mat. At contact points on the lower mat, the metal head still produced more significant damage than did the rubber head.

2.5 Discussion of Results

All three pairs of specimens showed that the vibration of concrete during placement can produce significant damage to coated reinforcing bars. Typical damage resulted from the abrasion of the vibrator head against the coating on the bar. Damage also resulted at places where reinforcing bars crossed each other and abraded each other during vibration. Vibrator damage was generally located on the ribs since they protrude from the bar's surface and are most readily contacted. However, in severely damaged locations the coating was completely removed from the surface of the ribs and from the area between them.

Coating damage was worst where the space available for the vibrator head was limited. In confined areas, the head of the vibrator was forced to contact the coated bars repeatedly. Contact of this sort, with both the metal and rubber vibrator heads, removed areas of coating from the reinforcing bars. However, the amount of coating removed was less with the rubber vibrator head than with an equivalent metal one.

Combining the average damage from the three specimens for horizontal bars (reinforcement in all test specimens except vertical bars in columns) shows an average damage percentage of 0.64% with the metal head, and 0.22% with the rubber head. Thus, the metal head did almost three times as much damage, overall, as did the rubber head. If the vibrator procedure had been more careless, or if the period of vibration was lengthened, the disparity is expected to be even greater.

Histograms of vibrator damage with both the metal and rubber heads were prepared to demonstrate the occurrences of different levels of damage. Only the damage percentages for horizontal bars were included in the histograms because, as previously discussed, the damage to the vertical bars in the column specimens was so minor with both metal and rubber heads. Figure 2.17 shows the damage histograms for both the metal and rubber heads. The histograms contain the damage percentages for all 0.3 m (1 foot) horizontal bar sections from each of the column, footing, and slab tests. Comparison of the two histograms readily reveals that the metal head does more damage than the rubber vibrator head. With the metal head, vibrator damage alone was greater than the current 1% total acceptable damage limit for 6.2% of the test sections evaluated. With the rubber head, this number dropped to 1.5%. With the metal head another 5.8% of the test sections fell in the 0.70-0.99% damage group. With even minor levels of fabrication, handling, and transportation damage, on the order of 0.3% or less, the damage on these bars would exceed acceptable limits. With the rubber head vibrator, however, only 0.39% of the test sections fell in the 0.70-0.99% damage group.

If the fabrication, handling, and transportation damage was on the order of 0.3 to 0.65% another 29% of the bars vibrated with the metal head would be unacceptable, while only an additional 5.8% of those vibrated with the rubber head would be over the acceptable limit.

The vast majority, 92%, of test sections vibrated with the rubber head had less than 0.35% damage. Even with up to 0.65% damage from fabrication, transportation, and handling, these bars would still have a final damage condition of less than 1% in their true in place condition. For the metal vibrator head, with damage prior to vibration at levels of 0.65%, over 40% of the test sections would have damage greater than the 1% limit, versus only 8% over this limit with the rubber head.

A further breakdown of damage figures in the 0-0.34% range for the metal and rubber heads is presented in Figure 2.18. As in the other figure, data for all 0.3 m (1 foot) bar sections from the three test specimens is included. The smallest damage group, from 0-0.050% would definitely be considered

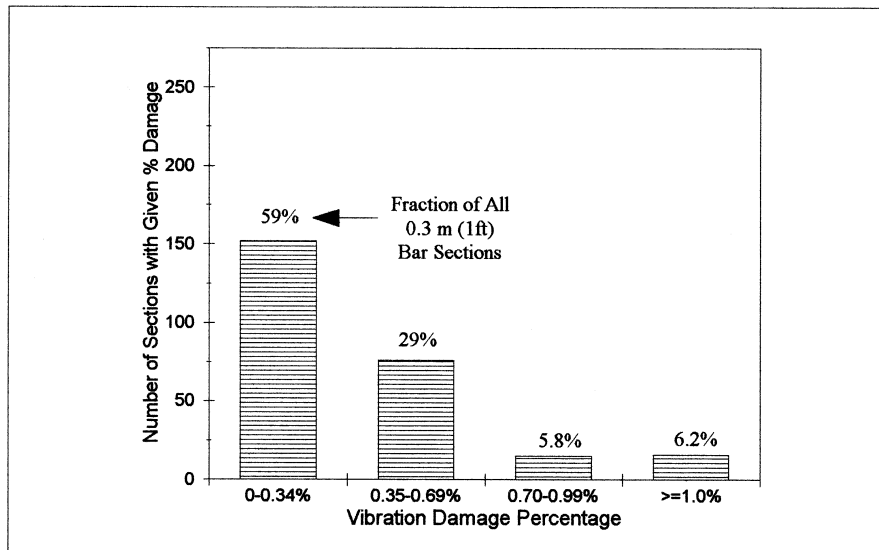

a) Metal Head

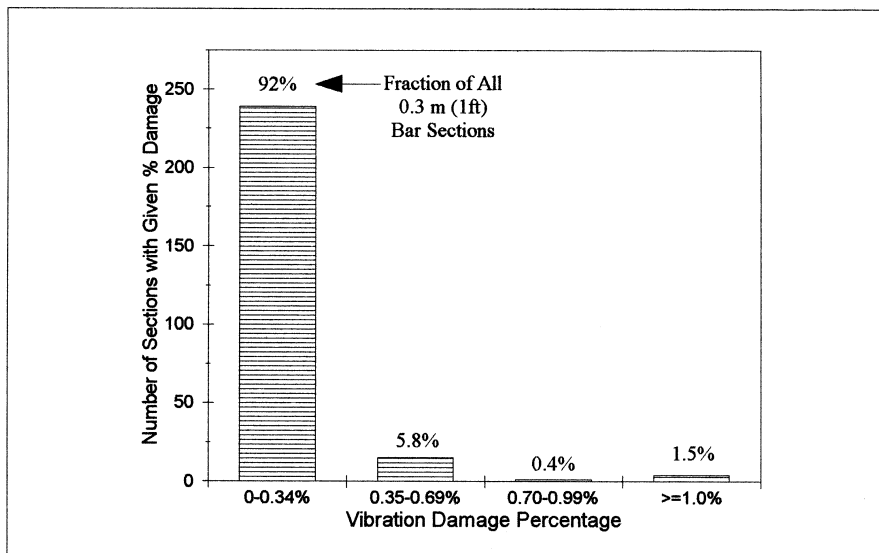

b) Rubber Head

Figure 2. 17 Histogram of damage percentages for 0.3 m (1 ft.) horizontal bar sections from column, footing and slab specimens

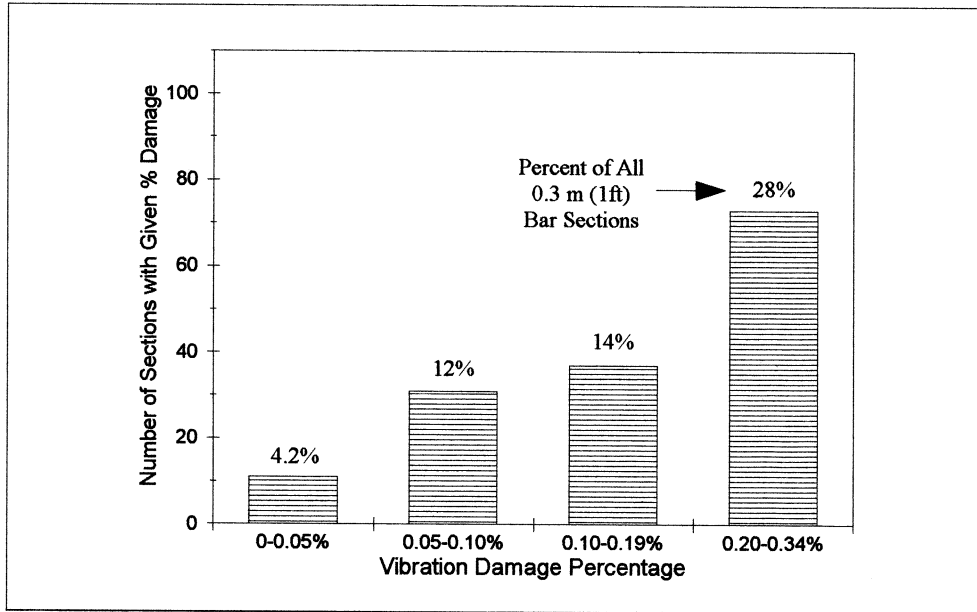

a) Metal Head

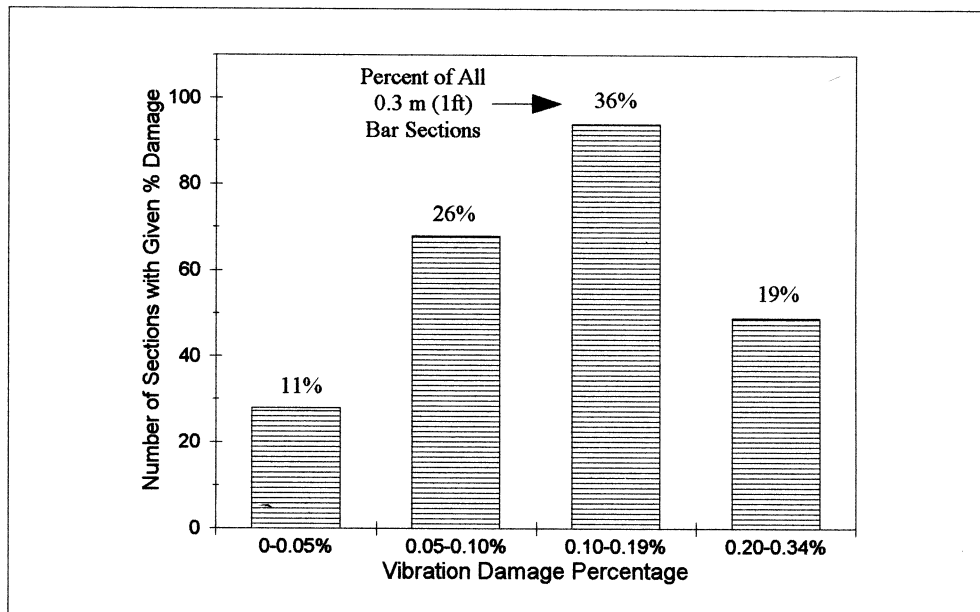

b) Rubber Head

Figure 2. 18 Histogram of damage percentages (0 - 0.34% range)

negligible, especially when field evaluation is considered. Damage of 0.050% on a 13 mm (#4) bar is less than one 3 x 3 mm (1/8 x 1/8 in) spot in 0.3 m (one foot) of bar. Damaged areas smaller than this size are only located through close scrutiny in a controlled laboratory environment where the bar can be moved and rotated to aid the inspection. In the field, damage of this order would not even be noted.

Damage in the next range, 0.051-0.09% is also considered negligible, in that it is again very unlikely damaged percentages this low would even be noticed. A damage percentage of this order equates to one 3 x 3 mm (1/8 x 1/8 in) spot in 0.3 m (one foot) of a 13 mm (#4) bar. Again, damage as insignificant as one small spot, or several very small spots, on a bar could easily be missed in a field investigation. Damage in the next range, 0.10-0.19%, is still very minor, but some of the damage might be noticed in field investigations. The area of damaged spots producing 0.20-0.34% is small, but probably would be at least partially noted in field studies.

Comparing the two heads, 4.2% of all (0.3 m) one foot bar sections from the metal head specimens fell in the 0-0.050% damage range, while 11% of the rubber head sections had this negligible level of damage. Thus, there were almost three times as many bar sections in this very negligible category after vibration with the rubber head as compared to that with the metal head. An additional 12% of the metal head sections were in the 0.051-0.099% range, while 26% of the rubber head sections fell in this group.

Examining the 0.10-0.19% damage group, 14 % of the metal head and 36% of the rubber head sections were in this category. And 28% of the metal head, and 19% of the rubber head bars were in the final 0.20-0.34% damage range. More bars from the metal head specimens fall in the 0.20-0.34% damage range than from the rubber head specimens. Larger numbers of bars from the rubber head test were grouped in the very low damage ranges than were bars from the metal head specimens.

Regardless of damage prior to casting, the rubber vibrator head does less damage to epoxy coatings during concrete placement than the metal head. Acknowledging that contact between the vibrator head and specimen reinforcement is inevitable, the quality of epoxy-coated reinforcement as it exists in a cast specimen will be better if a rubber vibrator head is used instead of a metal one.

2.6 Conclusions

The most important conclusion of the vibration damage testing is that even if the bars reach the concrete placement stage free of damage, they may still receive considerable damage during the placement operation. But, the use of a rubber head concrete vibrator will result in less damage than metal head vibrators. Close-up pictures of vibrator damage with both metal and rubber heads are shown in Figure 2.19. As the pictures shows, the metal vibrator head has totally removed the coating from a large area of the bar while the rubber head roughened the coating during vibration, but only removed the coating in a few small spots. Figure 2.20 shows two other pictures of the significant coating damage resulting from vibration with a metal head. Whether a metal or rubber vibrator head is used, epoxy-coated bars can be damaged through contact with the head. However, in all instances the metal vibrator head did more damage, on average, than did the rubber head. In some instances, the average damage produced with the metal head was over five times that done by the rubber head.

Based on the results of this study, damage due to concrete vibration with metal heads was over 5% of the bar area in a 0.3 m (1 ft) length of bar at the worst locations, while the worst single performance by the

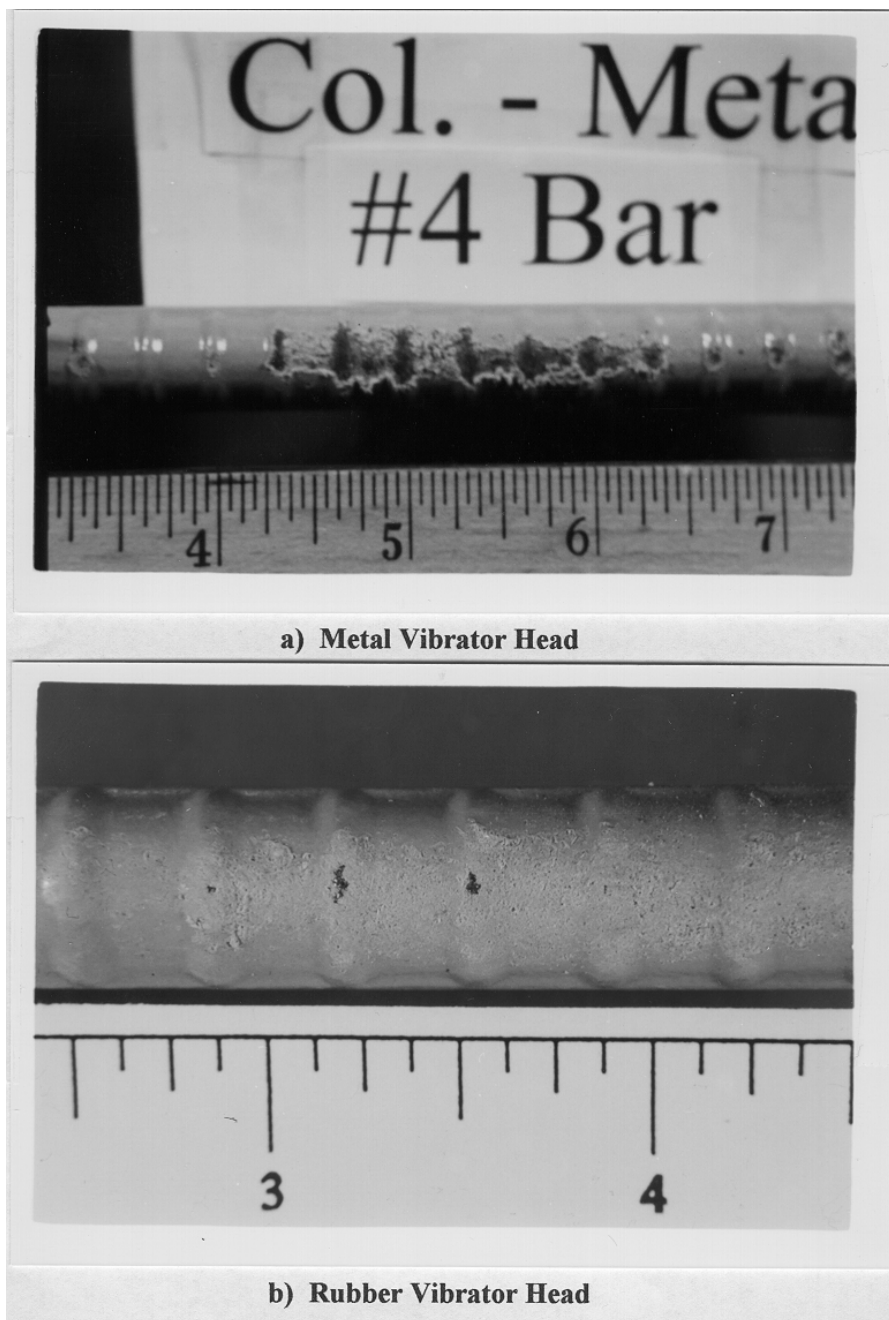

Figure 2. 19 Vibration damage to epoxy coating

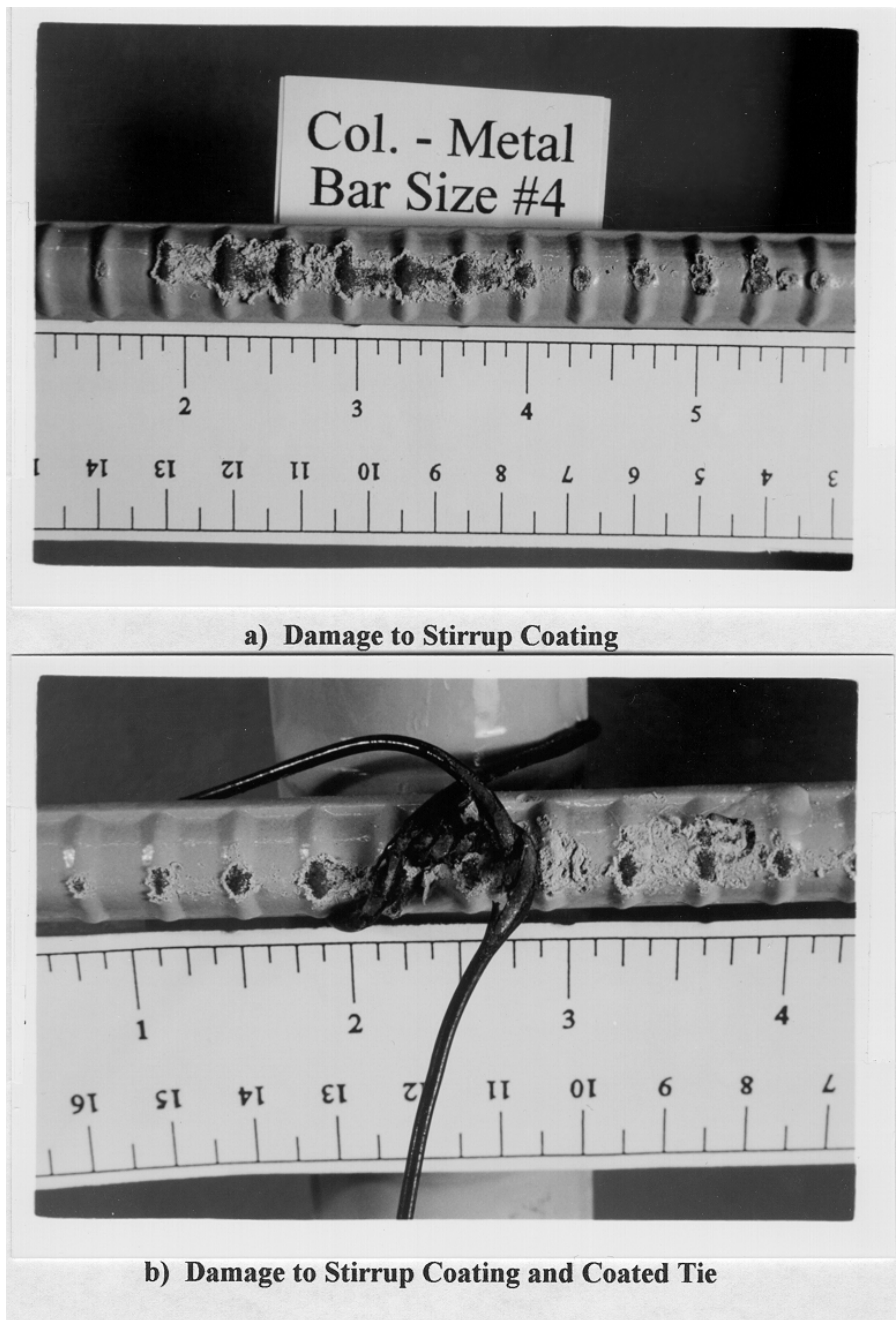

Figure 2. 20 Coating damage with metal vibrator head

rubber head produced 1.9% damage. On average, a metal head did almost three times the amount of damage done by a rubber head.

The levels of damage produced with both the metal and rubber head might seem relatively insignificant to someone not well versed in the area of epoxy-coated reinforcement. One might question whether it is worth the extra expense and complication in construction for just 2 or 3% less damage. Tests at the University of Texas have shown that differences in the damage condition of coated bars on the order of only 1% do have a significant effect on the performance of the bars from the corrosion point of view. Thus, changing procedures and equipment when consolidating concrete with epoxy-coated reinforcement to include the use of rubber head vibrators is definitely warranted, based on the expected reduction in coating damage.

Damage due to vibration can be reduced by 1) proper vibrating procedures and training of operators, and 2) using “soft” rubber vibrator heads. The operator must be trained to follow prescribed procedures. The vibrator should be inserted vertically, and should not be dragged across the coated bars. The vibrator head should be carefully inserted in the concrete and contact with coated reinforcement should be avoided. Especially in tightly confined areas, great care should be exercised to limit the duration and severity of contact between the head and the coated rebar. Under no circumstances should the vibrator head purposely be forced into contact with coated reinforcement. In placement operations with uncoated bars the vibrator may be held against reinforcing bars to “rattle the cage” and improve consolidation about the bars. This practice must not be permitted with coated bars as the direct contact between the head and bar will cause vibrator damage, as will rubbing between bar contact points. Furthermore the head of the vibrator should not be inserted between the outside of column stirrups and formwork. Not only is insertion of the vibrator head between the stirrup and formwork bad vibrating practice in general, such actions will result in excessive amounts of damage to the coated reinforcement.

A final recommendation for vibration of shallow, deck slab specimens with coated reinforcement is the importance of using short, slab length vibrator heads to consolidate the concrete. These shorter heads can be inserted vertically in the slab, while remaining immersed in the concrete of the deck. When a longer vibrator head is used it is necessary to insert the head at an angle or completely horizontally to keep the vibrator head immersed in concrete. Inserting the head at an angle or horizontally results in larger amounts of damage, as the head is dragged over the coated bars. Properly using a slab vibrator in a vertical orientation will minimize coating damage.

In summary, use of rubber vibrator heads will produce less damage than similar use of metal heads. Proper use of a rubber vibrator head should result in the least possible amount of damage to coated reinforcement during concrete placement.

CHAPTER 3

EVALUATION OF CONSOLIDATION DURING VIBRATION IN FRESH CONCRETE

3.1 Introduction

3.1.1 VIBRATION IN CONCRETE

Vibration is used in virtually all concrete construction, but usually without a significant knowledge of the theory and mechanism behind the mechanics of consolidation. This lack of understanding probably explains a good deal of misuse and insufficient use of vibrating equipment in the field.

The internal concrete vibrators of interest in this report utilize a rotating eccentric weight to deliver a vibratory force to the concrete. Vibrators of this type generate a simple harmonic motion that can be described by a sinusoidal wave equation. The sinusoidal oscillation is of the form:

$$y = s \sin(\omega t) = s \sin(2\pi ft)$$

where:

s = amplitude, mm (in)

ω = angular velocity, radian/sec

f = frequency, Hz

t = time, sec

The first and second derivatives of this equation yield particle velocity and acceleration, respectively. The later is of the form:

$$\ddot{y} = 4\pi^2 f^2 s \sin(2\pi ft)$$

The maximum acceleration during the motion is given by $4\pi^2 f^2 s$ mm/sec² (in/sec²).

The above equations show the relation between three significant components of vibration: frequency, amplitude, and acceleration. Vibrators are usually characterized by the frequency of vibration and the amplitude of vibration.

3.1.2 MECHANICAL CONCRETE VIBRATION

Early in this century, concrete was generally placed in a very dry consistency. The concrete was placed in shallow lifts, with the aid of heavy tampers. This procedure required extensive manual labor, but generally produced good quality concrete. But as concrete sections became smaller and the amount of steel reinforcement was increased, it became more difficult to adequately place very dry and stiff concrete mixes. Subsequently, the amount of water in the mixes was increased to make them easier to place. Unfortunately, the increased ease of placement came with a price, and that was the quality of the

concrete. The wetter mixes did not produce as good a concrete as was once obtained. The concrete had lower strengths, increased cracking, and less durability.¹¹

In the 1920's the water-cement ratio concept was conceived, confirming the observation that as the amount of water in the mix was increased, the quality of the concrete decreased. It was evident that the approach of indiscriminately adding water to the concrete to make it more placeable was not a good one. A better approach was to find a way to adequately consolidate stiffer concrete in smaller more congested reinforced sections. In the 1930's, machines designed to assist in placing concrete through the use of vibratory motion began to be developed. In the beginning, these machines had limited frequencies and had maintenance and design problems. But as time passed the science of concrete vibration progressed and much work was done on the use of vibration to consolidate concrete.¹¹

3.1.3 KEY FACTORS IN CONCRETE VIBRATION

In the 1940's, researchers began to articulate the key role that friction played in the consolidation of concrete. Friction between particles in the concrete was found to be the most important component resisting compaction efforts. It was found that by vibrating the concrete, this friction was substantially reduced and the concrete could be compacted.

Through the years of research, important components of vibratory action in concrete have been highlighted. The magnitude of the acceleration produced during vibration was found to have a primary responsibility in reducing internal friction in the concrete. The force applied to the concrete, the amplitude of the vibration, and the frequency of vibration were also noted as important factors affecting consolidation.

Past research in concrete vibration has indicated that consolidation of fresh concrete starts at an acceleration of about 0.5 g, and the compaction effort increases linearly up to accelerations between 1 g and 4 g. The specific point at which increased acceleration does not produce increased compaction is dependent on the consistency of the concrete mix. Additionally, there is a minimum amplitude required to consolidate the concrete. A minimum amplitude of 0.04 mm (0.0015") was proposed in 1963 by Kolek.¹¹

The American Concrete Institute (ACI) Committee 309 has outlined a set of four requirements for the consolidation of fresh concrete. These are:

1. Minimum acceleration for concrete of normal consistencies
2. Minimum dynamic pressure for very stiff concrete consistencies
3. Minimum vibratory amplitude for any given mixture
4. Minimum vibratory energy for all mixtures.

In the examination of concrete vibrators, it is helpful to remember these recommendations and to refer to them when evaluating the efficiency of a vibrator.

3.1.4 EFFECT OF CONCRETE MIX ON CONSOLIDATION

In 1968, Ritchie identified three main characteristics of concrete that had a significant affect on the ease with which it could be consolidated. These were stability, compactibility, and mobility. Stability is

defined as flow of the fresh concrete in the absence of external forces. It can be measured by bleeding and segregation characteristics. Compactibility is the ease with which fresh concrete can be consolidated. Compactibility tests have been devised to see how easy it is to expel entrapped air and to reorient the particles in the concrete in a denser arrangement. Mobility of the concrete relates to its viscosity, cohesion, and internal shear resistance. Mobility of a mix is affected by proportioning and the characteristics of the different materials that make up the concrete. These three parameters, stability, compactibility, and mobility, determine the suitability of a mix for placement.

The overall workability of a mix is affected by the composition of the mixture, and the amount of each constituent in the mix. The properties of each ingredient of the concrete, such as particle shape, size, porosity, and surface texture also have a significant impact on the nature of the mix. Additionally, the presence and qualities of admixtures and the mixing of the concrete will impact the compactibility of a given mix. The design of a concrete mix can thus have a significant effect on concrete placement and the amount of vibration required to adequately consolidate the concrete through choices made during mix design.

3.2 Vibration Test in Fresh Concrete

3.2.1 TEST SPECIMENS

Vibration tests were conducted in two unreinforced, freshly placed concrete blocks. The forms used for the tests were 91 cm by 91 cm (36" by 36") in plan, but were of different heights. The forms had been prepared for a separate test in which different height specimens were required. The height of the forms was not critical in this testing since equal amounts of concrete, with a depth of 20 cm (8"), were placed in each form for vibration testing.

A wooden assembly was constructed to support two electrical receptacle boxes from the top of the forms as shown in Figure 3.1. Each metal box was immersed in the concrete approximately 4.5 cm (1.75"). The metal boxes were used as a housing for small size, high sensitivity, high frequency accelerometers. The boxes protected the accelerometers from the concrete, while permitting measurement of the wave motion in the concrete during vibration. A section was cut out on one side of each form for attachment of another receptacle box, as shown in Figures 3.1 and 3.2. The accelerometers were attached with magnets to the receptacle boxes during the tests.

The two receptacle boxes suspended from the top of the formwork were positioned at 10 cm (4") and 20 cm (8") respectively from the vibrator's point of insertion, as shown in Figure 3.2. The figure also shows the position of the receptacle box on the side of the form. The suspended receptacle nearer to the point of insertion is labeled Station A, the farther one is Station B, and the box attached to the side of the form is Station C.

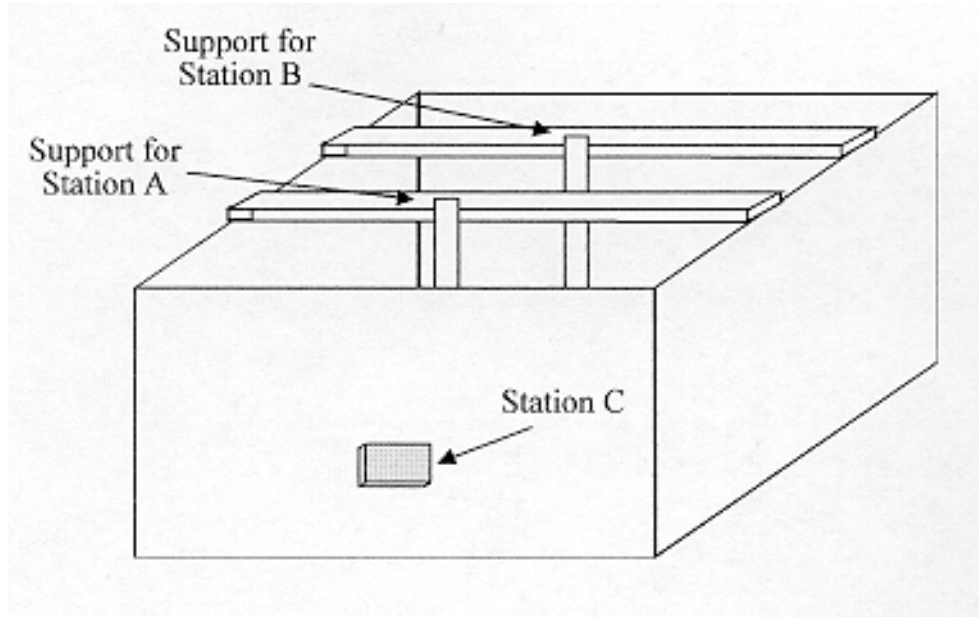

Figure 3.1 Recording station locations

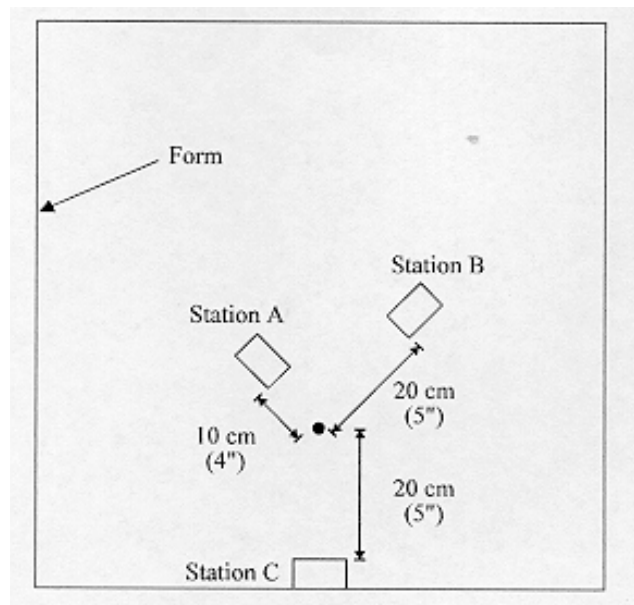

Figure 3.2 Data station positions

The concrete used in this test was relatively stiff with a 5 cm (2") slump. The specific mix design of the concrete is given in the appendix.

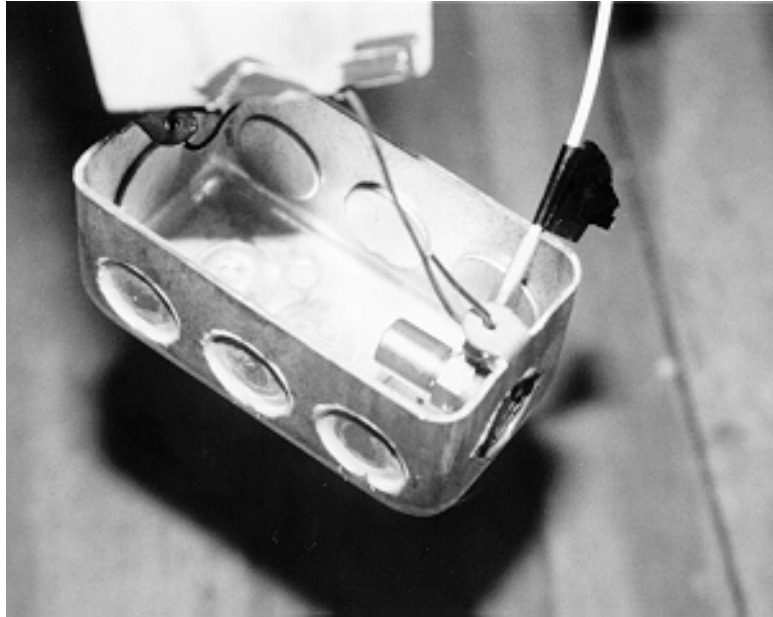

Figure 3.3 Accelerometer in receptacle box

3.2.2 TEST PROCEDURE

Concrete was placed from an overhead bucket into each of the two forms at the beginning of the test. The concrete was vibrated with a flexible shaft type internal vibrator with the same electric 2.4 amp motor used in all of the vibration tests. The same operator vibrated the concrete in each of the tests to attempt to minimize any effect the operator might have on the results. In the first set of tests, the concrete in the short form was vibrated with a rubber vibrator head. While the concrete was being vibrated, measurements were taken with the accelerometers at different stations and in different orientations. Figure 3.3 shows a typical accelerometer used in this test. A drawing of the

accelerometer and a list of some of its useful features are given in Figure 3.4, and accelerometer orientations used during the testing are shown in Figure 3.5. The data acquisition system used in this experiment could monitor only 2 channels (Figure 3.6), so it was necessary to move the accelerometers during the test to take readings at all desired positions. The first set of measurements were made at Stations A and B with the accelerometers oriented horizontally. Next, the accelerometers were oriented vertically at the same stations. The final measurements were made at Station C, with the accelerometer oriented horizontally, and then vertically.

The next test utilized a metal vibrator head in the tall form. The same schedule of accelerometer placements and orientations described above was used in this test. The final test involved the use of the rubber vibrator head in the tall form. Again the placement and orientation schedule was the same, except that in the final test it was completed in the reverse order.

3.3 Test Results

3.3.1 GENERAL OBSERVATIONS

The concrete used in this experiment was placed with a relatively low slump of 5 cm (2"). Subsequently, as the time after placement elapsed and the time of vibration increased, the concrete became quite stiff. Particularly in the tall form where the concrete was first vibrated with a metal vibrator head and then a

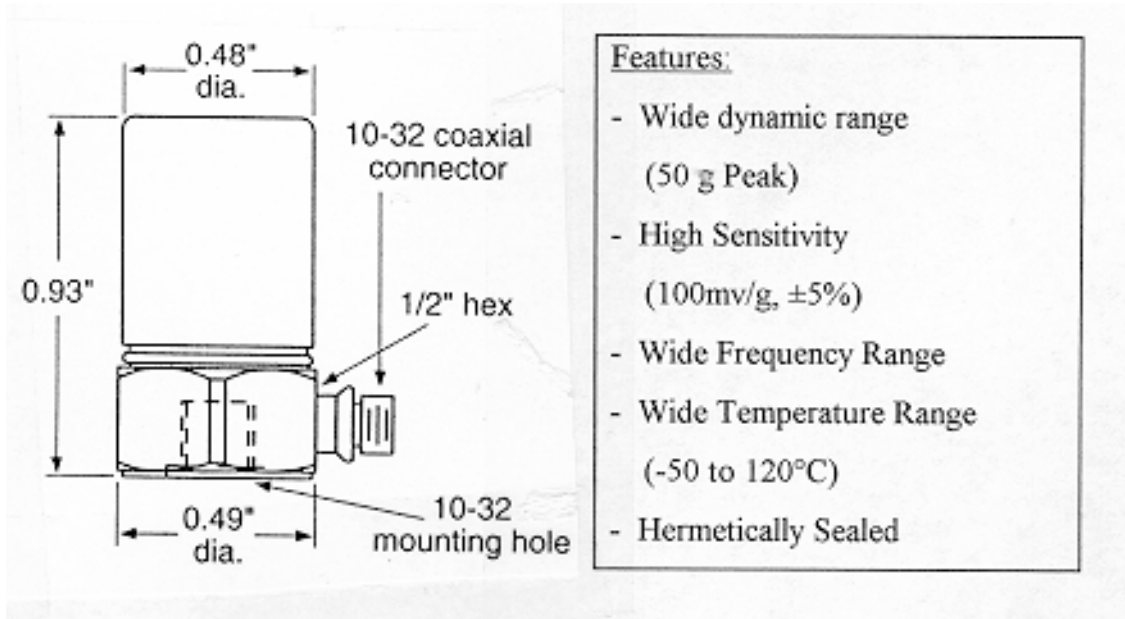

Figure 3. 4 Accelerometer features

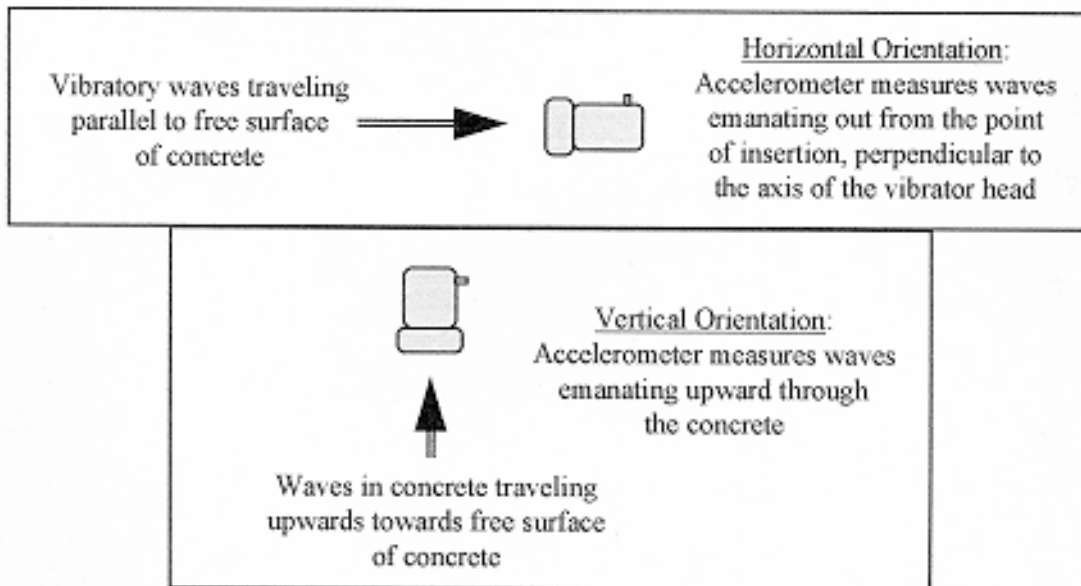

Figure 3. 5 Accelerometer orientation



Figure 3.6 Data acquisition system

rubber head, the interparticle friction of the mix was very high during the latter part of the test. In this form the concrete was overvibrated by the end of the test, and segregation of the concrete was seen in approximately a 5 cm (2") area around the head. The area of very visible segregation did not extend, however, to either Station A, B, or C, so it is felt that this condition did not have a significant effect on the data obtained from the test. The point that is important in analyzing the data from the test is the observation that as time passed the concrete in both forms became stiffer as the concrete set.

Concrete was placed in both of the forms at the beginning of the test, and the rubber vibrator head was immediately used to vibrate concrete in the short form. Vibration tests could not be conducted in both forms simultaneously due to equipment limitations. The concrete was in the tall form for at least 20 minutes before the metal vibrator head was inserted for consolidation. Subsequently, the concrete in the tall form was stiffer at the beginning of the metal head test than was the concrete in the short form at the beginning of the rubber head test. This conclusion was also validated by observations of the concrete during the vibration tests. It was noted during the test that when the metal head test was begun the concrete in the tall form was stiffer than the initial condition of the concrete for the rubber head test. This is an important observation because properties of the concrete, particularly its workability or slump, affect the ease with which the concrete can be vibrated, or in other words, the efficiency of the vibrator.

With a stiffer mix the motion of the vibrating head will be more restrained than in a looser mix. The metal vibrator head was tested in concrete from the same batch, but that was less workable than that used with the rubber head. Therefore, the metal vibrator head was tested in a more severe environment than that of the rubber head. If the two heads were normally expected to produce adequate consolidation, in this case the metal head would likely be less efficient than the rubber head.

Observations of the fresh concrete surface appearance during the vibration test confirmed that all data stations were within the vibrator's area of influence. Thus, the data recorded at each station is representative of vibratory motion within the radius of action of the vibrator.

3.3.2 DATA RECORDED DURING TEST

Power spectrum records and time records were produced by the data acquisition system during the vibration test. The power spectrum records contain $(V_{rms})^2$ readings versus the frequency in hertz. The power spectrum record was constructed by taking five readings and doing a peak hold on the $(V_{rms})^2$ reading at each frequency. The time record contains the accelerometer voltage versus time at 2048 points over a 400 ms recording period. Several records were taken of both the time and power spectrum data at each location during the tests.

3.3.2.1 Frequency Data

Plots of the power spectrum records from the tests had an appearance similar to that of Figure 3.7. As shown, the $(V_{rms})^2$ data has been plotted versus the frequency. The spikes in the curve represent dominant frequencies in the concrete during vibration. The frequency of the first spike in the curve, which is by far the largest spike in Figure 3.7, will be referred to as the dominant or peak frequency.

3.3.2.2 Acceleration Data

Plots of the time records from the vibration tests had an appearance similar to that of Figure 3.8. The graphs show particle acceleration in the concrete through time as the concrete was being vibrated. As previously described, the acceleration charts have a sinusoidal type appearance.

3.3.3 DISCUSSION OF RESULTS

3.3.3.1 Frequency Results

The power response data from the rubber and metal head vibrator tests show a difference in frequency between the two vibrator heads. Tables 3.1 and 3.2 summarize frequency data at Stations A and B. Tables 3.3 and 3.4 show the data from Station C. For ease of comparison, the frequency of the first spike reading at Stations A, B, and C were averaged and these averages are compared in the following discussion. The average of all frequency readings for each of the three tests are presented in Table 3.5.

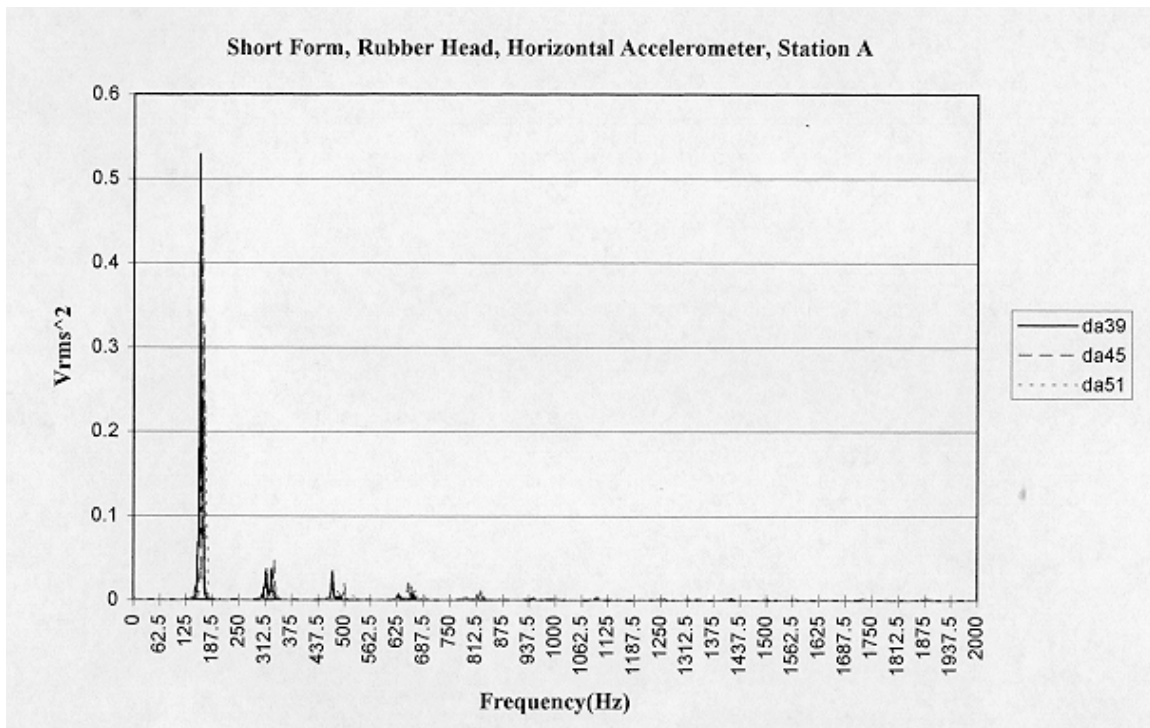

Figure 3.7 Typical power spectrum record

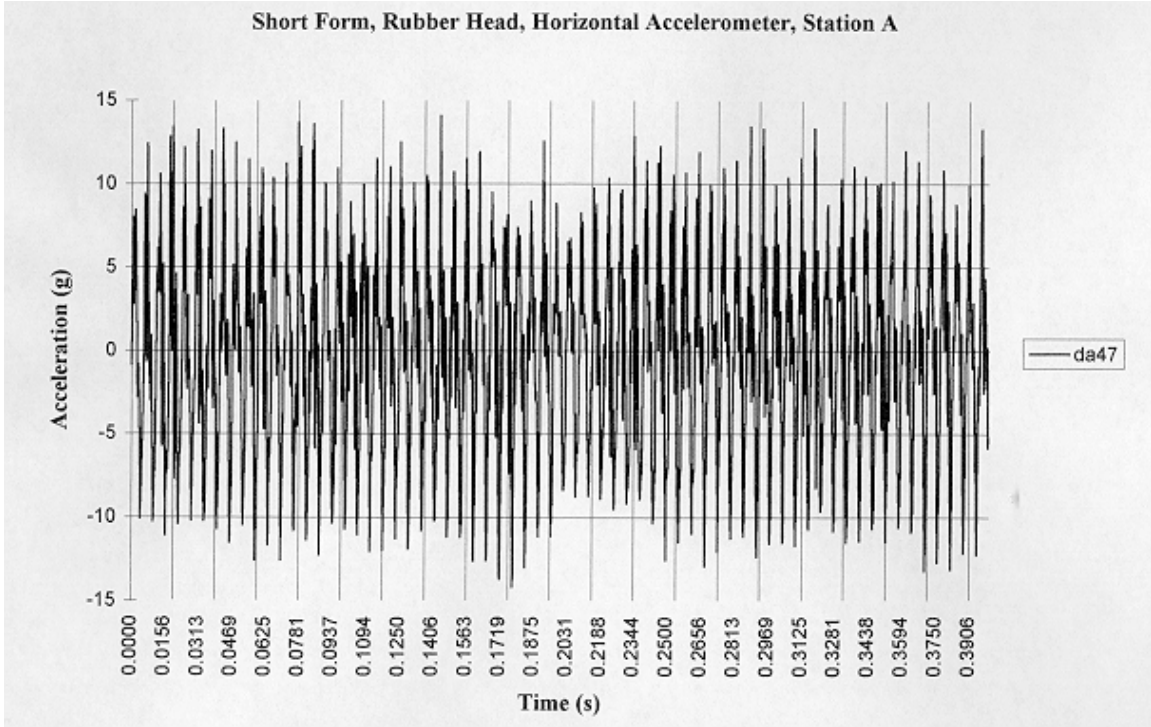

Figure 3. 8 Typical time record

Table 3. 1 Peak Frequency from Horizontal Surface Measurements

Test	Peak Frequency (measured horizontally)		$(V_{rms})^2$
	(Hz)	(vpm)	
Rubber Head in Short Form Station A	162.5	9,750	0.29
Rubber Head in Short Form Station B	165.0	9,900	0.05
Metal Head in Tall Form Station A	192.5	11,550	0.33
Metal Head in Tall Form Station B	192.5	11,550	0.05
Rubber Head in Tall Form Station A	177.5	10,650	0.04
Rubber Head in Tall Form Station B	180.0	10,800	0.02

Table 3.2 Peak Frequency from Vertical Surface Measurements

Test	Peak Frequency (measured vertically)		(Vrms) ²
	(Hz)	(vpm)	
Rubber Head in Short Form Station A	167.5	10,050	0.94
Rubber Head in Short Form Station B	172.5	10,350	0.40
Metal Head in Tall Form Station A	195.0	11,700	0.74
Metal Head in Tall Form Station B	195.0	11,700	0.22
Rubber Head in Tall Form Station A	177.5	10,650	2.60
Rubber Head in Tall Form Station B	177.5	10,650	0.60

Table 3.3 Peak Frequency from Horizontal Side Measurements

Test	Peak Frequency (measured horizontally)		(Vrms) ²
	(Hz)	(vpm)	
Rubber Head in Short Form Station C	172.5	10,350	0.24
Metal Head in Tall Form Station C	202.5	12,150	0.07
Rubber Head in Tall Form Station C	175.0	10,500	0.04

Table 3.4 Peak Frequency from Vertical Side Measurements

Test	Peak Frequency (measured vertically)		(Vrms) ²
	(Hz)	(vpm)	
Rubber Head in Short Form Station C	175	10,500	0.19
Metal Head in Tall Form Station C	202.5	12,150	0.07
Rubber Head in Tall Form Station C	172.5	10,350	0.06

Table 3.5 Average Peak Frequency

Test	Peak Frequency (average)	
	(Hz)	(vpm)
Rubber Head in Short Form Station A,B,C	170	10,200
Metal Head in Tall Form Station A,B,C	195	11,800
Rubber Head in Tall Form Station A,B,C	175	10,600

As shown in the table, the average peak frequency with the rubber vibrator head was 10,200 vibrations per minute (vpm) in the first test in the short box and 11,800 vpm with the metal head in the tall box. The final test frequency with the rubber head in the tall box was 10,600 vpm. These results suggest that the frequency in the concrete when

vibrating with the rubber head is less than that obtained with the metal vibrator head. There is about a 10% difference in frequency between the two heads, with the metal head showing the larger frequency.

There is a spread in the peak frequency between data records for the same vibrator head in the same box. In general, the frequency increases as the concrete continues to be vibrated. As previously discussed, an experienced operator can listen to the pitch of the motor as an indication of when the concrete has been sufficiently vibrated. The pitch will momentarily drop, then increase as the concrete is vibrated, reaching a relatively constant value when the concrete has been sufficiently vibrated. The increase in pitch heard by the operator agrees with the increase in frequency seen in successive data readings in the concrete. Therefore, the frequency in the concrete cannot be given as an exact absolute number, but is better characterized by an average of data as is shown above.

The important information to gather from the frequency data is that 1) the average peak frequency in the concrete is about 10% less with the rubber head than with the metal head, and 2) the range of peak frequencies over the successive tests is less with the rubber head than the metal head. So even though there is not a single number that can be set forth as a single frequency produced when using a specific head, it is still possible to compare the performance of the two heads. In doing so, it has been determined that use of the rubber vibrator head results in a lower peak frequency than that obtained with the metal head.

3.3.3.2 Horizontal Acceleration Results

As previously discussed, the concrete was in the tall form for at least 20 minutes before testing began, and as a result that concrete was stiffer at the beginning of the metal head test than was the concrete at the start of the first rubber head test. A concrete vibrator will perform less efficiently in a stiff mix than it will in a looser mix. The concrete in a looser mix is more flowable and the vibratory action will have greater effect on the surrounding concrete. Thus, a vibrator will produce more significant horizontal particle accelerations in a flowable mix than it will in a stiffer mix. Consequently, the metal vibrator head was working under more difficult conditions than the rubber head, and if anything, would have been expected to perform less efficiently than the rubber head.

The time records from the vibration tests show that the horizontal particle acceleration induced in the concrete with the metal vibrator head is greater than that obtained with the rubber head. Table 3.6 summarizes the horizontal acceleration data at Stations A and B. Comparison of the first rubber head test accelerations at Station A with that of the metal head shows a 12% difference, with the metal head producing larger horizontal accelerations. The average acceleration in the concrete was also computed

Table 3.6 Horizontal Accelerations at Stations A and B

Test	Max. Horizontal Acceleration (g)	Avg. Horizontal Acceleration (g)
Rubber Head in Short Form Station A	9.4	4.0
Rubber Head in Short Form Station B	5.5	1.8
Metal Head in Tall Form Station A	10.6	4.5
Metal Head in Tall Form Station B	7.4	2.3
Rubber Head in Tall Form Station A	5.2	1.7
Rubber Head in Tall Form Station B	3.4	1.4

from the data and it showed a 12% difference between the metal and rubber heads too, with the metal head producing an average of 4.5 g and the rubber head producing 4.0 g.

A larger difference was seen between the first rubber head test and the metal head test at Station B. The data shows a 29% difference in maximum acceleration, and a 24% difference in average acceleration, with the metal head vibrator again producing the more substantial horizontal accelerations.

At Station B, the reduction in acceleration was even greater with the rubber vibrator head compared to the metal head. The percent difference between the rubber and metal heads at Station B was twice that at Station A. The increased difference between the two heads suggests that the area of influence for the rubber vibrator head is less than that of the metal head. At increasing distances from the point of vibrator insertion, the rubber head produced increasingly smaller accelerations. This behavior would be expected to continue, hence, the effective area of the rubber head is less than that of the metal head.

A further comparison of the rubber vibrator head to the metal head was made by revibrating the concrete in the tall form with the rubber head vibrator. At Station A the maximum horizontal acceleration during the second test in the tall form was 5.2 g and the average was 1.7 g. The maximum acceleration shows 68% difference from the metal head, and the average is 90% different. At Station B, the maximum acceleration shows 74% difference and the average is 50% different. Again, the metal head vibrator produced substantially larger accelerations.

In the tall form, the rubber head would not necessarily have been expected to produce quite as large accelerations as the metal head had, since the concrete in the form had already been adequately vibrated and was quite dense. However, it was not expected that the horizontal accelerations in the concrete would be so drastically reduced with the rubber head as compared to the metal head. The last readings in the concrete with the metal vibrator head immediately prior to testing of the rubber head show that the metal head was producing substantially more vibratory force than did the rubber head in relatively similar conditions. Thus, the rubber head vibrator again is shown to produce less horizontal particle accelerations in the concrete than does the metal head.

Readings of the horizontal particle acceleration were also made at Station C in each of the forms. Table 3.7 summarizes the data from this station. Again, the metal head produced larger horizontal accelerations than the rubber head. There is an 18% difference between the maximum acceleration between the first rubber head test and the metal head test, and 33% difference between the metal and second rubber head

Table 3.7 Horizontal Accelerations at Station C

Test	Max. Horizontal Acceleration (g)	Avg. Horizontal Acceleration (g)
Rubber Head in Short Form Station C	8.6	3.2
Metal Head in Tall Form Station C	10.3	4.6
Rubber Head in Tall Form Station C	7.4	3.2

tests. The percent difference between the average accelerations of the rubber head and metal head was 28% in both tests.

Further information can be gained by comparing the accelerations at Station B to C. These two stations are at the same distance from the point of insertion of the vibrator, but Station C is located 13 cm (5 in) from the surface, while Station B is immersed only 4.5 cm (1.75 in) in the concrete. Comparing the data from Stations B and C in each test reveals that the horizontal accelerations are larger at C. There are more significant horizontal accelerations in the middle of the concrete layer, than there are closer to the surface. In all of the data, though, the horizontal accelerations produced in the concrete are less with the rubber vibrator head than with the metal head.

3.3.3.3 Vertical Acceleration Results

Normally in discussions of concrete vibrators, the acceleration and amplitudes under examination are related to horizontal motions in the concrete. The vibrator is supposed to be inserted vertically in the concrete, and the eccentric weight in the head produces waves that emanate out from the head, perpendicular to its center line. However there are also vertical accelerations induced in the concrete. This component of acceleration arises from the operator moving the vibrator head up and down during consolidation of the concrete, and from the rise of entrapped air bubbles, and the general settling of the concrete during vibration. A record of the vertical accelerations in the concrete was made during this vibration test. Table 3.8 summarizes the vertical acceleration readings at Stations A and B.

Table 3.8 Vertical Accelerations at Stations A and B

Test	Max. Vertical Acceleration (g)	Avg. Vertical Acceleration (g)
Rubber Head in Short Form Station A	16.5	7.9
Rubber Head in Short Form Station B	10.9	5.2
Metal Head in Tall Form Station A	18.0	7.2
Metal Head in Tall Form Station B	8.6	3.7
Rubber Head in Tall Form Station A	17.3	9.1
Rubber Head in Tall Form Station B	8.7	4.9

Unlike the horizontal accelerations in the concrete, the vertical accelerations were generally greater with the rubber head than with the metal vibrator head. The increase in vertical accelerations with the rubber head is attributed to the physical design of the rubber vibrator head, as will be discussed later in this section. At Station B, the maximum vertical acceleration was 10.9 g with the rubber head in the short box, 8.7 g with the rubber head in the tall box, and 8.6 g with the metal head. Thus, the maximum acceleration of the rubber head in the first test was a good deal larger (24% different) than that of the metal head at Station B, and still slightly larger in the second test. The average accelerations at Station A

showed a similar relationship, in that the rubber head was 9% different from the metal head in the first test and 23% different in the second test, with the rubber head producing greater average accelerations in both instances. The maximum vertical accelerations at Station A, however, were greater with the metal head. There was a 9% difference between the first rubber head test and the metal head test, and a 4% difference for the second rubber head test.

Since the maximum vertical accelerations at Station A were greater with the metal head, and the average was greater with the rubber head, it cannot necessarily be deduced that one outperformed the other at this station. However, the rubber head produced larger maximum and average accelerations at Station B. The vertical acceleration readings from Station C are presented in Table 3.9. The data from this station also shows larger maximum and vertical accelerations with the rubber vibrator head than the metal head.

Table 3.9 Vertical Accelerations at Station C

Test	Max. Vertical Acceleration (g)	Avg. Vertical Acceleration (g)
Rubber Head in Short Form Station C	6.9	2.8
Metal Head in Tall Form Station C	6.1	2.0
Rubber Head in Tall Form Station C	5.9	2.1



Figure 3.9 Metal (top) and rubber vibrator heads

Since the metal vibrator head produced substantially larger horizontal accelerations than did the rubber head, it might seem curious that comparison of vertical accelerations does not yield the same conclusion. This is probably due most to the design of the two vibrator heads. The shape of the metal head could best be described as a smooth cylindrical shape with a conical tip at the end, as shown in Figure 3.9. Also shown in the figure is the rubber head that has a steel core surrounded by rubber. The rubber sheathing on the soft head vibrator is not continuous, but is made up of several ring segments. Between successive segments, there is an open area through which the

steel core of the head can be seen. An earlier design of the soft head vibrator did have a continuous plastic cap over the steel core, but this design did not work well since the concrete could not effectively cool the vibrating head.

When an internal concrete vibrator is operated, either in concrete or in air, the vibrating head quickly becomes very hot. In fact, it is recommended that the vibrator not be operated in air for more than 5 or 10 seconds since the head will become too hot. In normal use, the concrete itself serves as a coolant for the head. As the vibrator is operated, the concrete flows around the head, and the heat from the head is

dissipated into the concrete. In this way, the vibrating head is cooled during its operation. When the entire metal core is coated with a plastic sheathing, though, the rubber serves as an insulator keeping the heat inside the core, and the concrete can not serve as a heat sink for the head. When the head is not cooled by the concrete, first the head, and then the flexible shaft, will become very hot. It will be uncomfortable, if not dangerous, for the operator to hold the shaft with bare hands, and the shaft may become so hot that it can not easily be held with gloved hands, either.

By breaking up the rubber on the soft head into rings, and leaving accesses through which the concrete can contact the metal core, the vibrating head can be cooled. The concrete flows between the rings, in and out during vibration, dissipating the heat of the head. Subsequently the vibrator will work more efficiently, and will last longer, and the operator will be able to safely use the equipment. With both the metal and soft head vibrators, though, the operator should wear gloves since after a relatively short time in operation the shafts of each may become hot enough to be uncomfortable to hold with bare hands. With the rubber ring design, though, operation with the soft head is not significantly different from that of the metal head, with respect to vibrator heat.

The design of the rubber rings, though, have a secondary effect other than assisting in cooling the head. The design results in the production of larger vertical accelerations in the concrete than does the smooth, round metal head, especially farther away from the head. If one were to compare moving a smooth stick up and down in water to moving a rough stick with several branches on it up and down in the same water, the same type of relation would occur. The smooth stick would not greatly agitate the water, since there are few horizontal surfaces available to disturb it. The rough stick, though, would disturb the water much more, since the appendages projecting out into the water would move the water about. This relation is true for the metal and rubber heads as well. The smooth, round metal head will disturb the concrete less as it is moved up and down than will the rough and uneven surface of the rubber head. The horizontal surfaces of the rubber rings push the concrete vertically as the vibrator is moved up and down. Subsequently, larger vertical accelerations are expected with the rubber head, especially at increased distances from the insertion point. The data from the vibration tests confirms this supposition.

3.4 Conclusions

The waves that emanate horizontally from a vibrating concrete head lend energy to entrapped air bubbles, helping them to escape, and thus densifying the concrete. These waves reduce internal friction in the mix, allowing the concrete to flatten out and reach a lower energy state. The science of concrete vibration is based on the characteristics of these horizontal waves, and how effective they are at consolidating concrete mixes.

Based on the measurements taken in this study, the metal vibrator head sends out more significant horizontal waves into the concrete than does the rubber head. Horizontal particle accelerations with the metal head were greater than those with the rubber head, both close to the insertion point of the vibrator, and farther from this point. Hence, based on use with the same vibrator motor and comparable flexible shafts, the metal vibrator head imparted more energy to the surrounding concrete than did the rubber head.

The fact that the rubber head produced less vibratory action in the concrete than would be expected from a similarly sized metal head vibrator is attributed to the dampening effect the plastic rings have on the waves emanating from the metal core of the rubber head. The presence of the plastic sheathing results in

the passage of less energy from the metal core of the rubber head to the surrounding concrete during vibration. Thus, the rubber heads vibrate the concrete less efficiently than would be expected from a metal head of the same size.

Although a significant difference between the metal and rubber head was seen at data locations near the insertion point, an even larger difference was seen at data stations farther from the vibrating head. Thus, not only did the metal head produce more significant accelerations than the rubber head throughout the area of influence, but also its vibratory action away from the point of insertion is dropping off at a slower rate than the rubber head's. The metal vibrator head produces significant accelerations in a larger area of concrete surrounding the point of insertion, or in other words, the area of influence of the metal head is larger than that of the rubber head.

As noted in the discussion of results, the frequency in the concrete during vibration was about 10% less with the rubber head than with the metal head. The higher particle frequencies seen with the metal head indicate that the metal head will consolidate concrete more quickly and efficiently than the rubber head.

The only area of measurement in which the rubber vibrator head produced more significant action than the metal head was the vertical particle acceleration readings. But as discussed at length in the previous section, this occurrence is attributed to the physical design of the rubber head, its irregular shape and the presence of numerous horizontal surface. Some metal vibrator heads are constructed with a thickened tip at the end and irregular surfaces as it has been recognized that the design of the head affects the consolidation of the concrete. The modified shape of a metal vibrator head alters the effect of the vibrator as it is moved up and down in the concrete during the consolidation process, just as the irregular shape of the rubber encased heads does. Thus it is reasonable, and expected, that the vertical accelerations in the concrete vibrated with the rubber head were larger than those seen with the smooth metal head. This occurrence, however, does not mean that the rubber head vibrator is better at concrete consolidation than the metal head. The increased vertical accelerations with the rubber head instead confirm the fact that altering the shape of the vibrator head affects the action of the vibrator, particularly with respect to vertical motion in the concrete.

Based on the tests conducted it is concluded that 1) a metal vibrator head will more efficiently and rapidly consolidate a concrete mix than will a comparable rubber head, and 2) that the area of influence with a metal vibrator head is larger than that of a comparable rubber head. These findings should hold for vibration of concrete mixes similar to the tested mix, but there may be some variation with very lean or rich mixes, or concrete mixes with significantly different workability.

CHAPTER 4

EVALUATION OF CONSOLIDATION IN HARDENED CONCRETE AFTER CONCRETE VIBRATION

4.1 GENERAL

The effects of concrete consolidation on the corrosion performance of steel reinforcement has not been strongly emphasized in literature. However, in earlier work on this project it was found that the condition of the concrete surrounding epoxy-coated bars plays a significant role in the corrosion process.⁴ Subsequently, the ability, or inability, of a vibrator head to adequately consolidate concrete, particularly around reinforcing bars, is of great importance.

During the consolidation of concrete, water migrates towards the top surface of a specimen. But some bleed water is trapped in the concrete, particularly below horizontal bars. As the concrete settles, it has been shown that small gaps form under the coated reinforcing bars. The formation of gaps is augmented by the lack of interlock between the mortar and the surface of the coated bar. Free water is able to accumulate in the zone beneath the bar, and when this water evaporates, air pockets are left under the bar. A test reported by Kahhaleh⁴ showed that while the concrete above a coated bar was well compacted, a gap formed below the bar.

As discussed in Kahhaleh's work, the gap area beneath the bar may serve as a trap for water, oxygen, and chlorides. The presence of these agents encourages the onset of corrosion in the steel. Particularly since these substances are in such close proximity to the bar there will likely be deleterious effects on the corrosion performance of the coated steel. As the corrosive agents penetrate to the steel through damaged areas and holidays, corrosion may be initiated and widespread undercutting of the epoxy film may result.⁴

In addition to the migration of water, entrapped air bubbles also rise to the surface of a specimen during vibration. Some of these air bubbles are trapped below large objects, like horizontal reinforcing bars, during the vibration of concrete. The existence of these air bubbles below the reinforcement exacerbates the condition of gap formation described above. Not only can a gap form below the coated bar, but also large air voids may collect beside and beneath it. Harmful agents, such as water, oxygen, and chlorides, can collect in these voids.

As a consequence of the migration of water and air bubbles, and their collection below reinforcing bars as described above, the concrete environment below the coated bar may be different from that above it. This difference is expected to negatively impact the corrosion performance of the coated reinforcement. Water carrying chloride ions may be trapped in voids at damaged spots in the coating. These spots may be more prone to corrode than areas with well-compacted more alkaline concrete in contact with the coated bar. Furthermore, the differences between areas of concrete bordering the reinforcement may promote the development of concentration cells.

Earlier work on this project has shown that corrosion activity does take place where voids in the concrete border the steel. Wetting and drying of voids, as well as the concentration of oxygen and chlorides in voids, promote corrosion at damage spots on the coated bars. When a damaged spot is exposed to corrosive agents, the localized area of steel cannot passivate, and the process of corrosion will progress. Especially at larger damaged spots on the bottom of a coated bar where voids are adjacent to the surface, localized corrosion may be extensive. Large pits were observed where significant areas of coating damage bordered voids in the concrete in corrosion specimens evaluated in earlier work on this project.⁴ A picture of a blister in the epoxy-coating where it was adjacent to a void is shown in Figure 4.1, and an extensively corroded area of reinforcement on the bottom of an epoxy-coated reinforcing bar is shown in Figure 4.2.

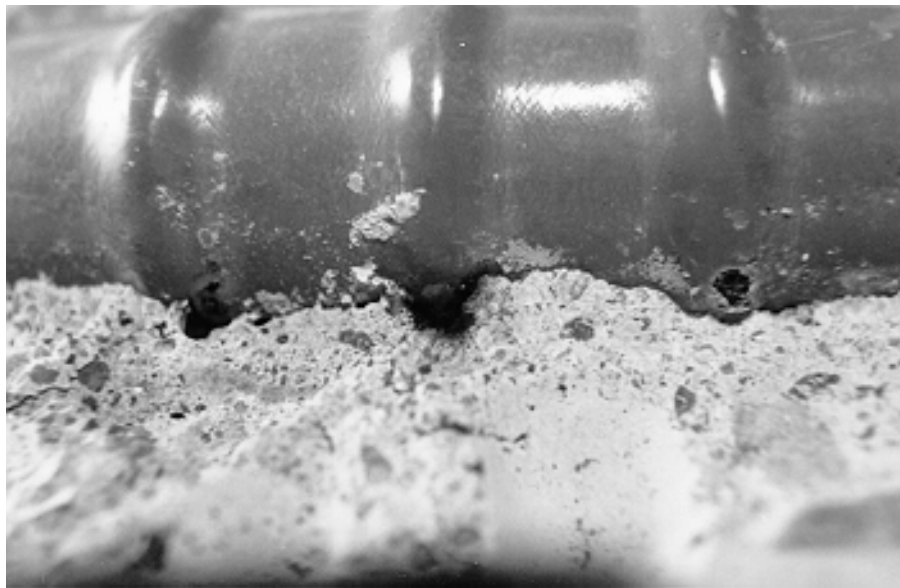

Figure 4.1 Blister at bottom side of coated bar

Since concrete consolidation, particularly in the area surrounding reinforcement, has been shown to play a significant role in the corrosion performance of coated bars, the ability of the new rubber vibrator heads to adequately consolidate concrete specimens has been investigated. The area of voids under reinforcing bars in specimens consolidated with rubber and metal vibrator heads was evaluated. Also, the density and permeable void content of cores from the consolidated specimens were determined for further comparison of the two heads relative consolidating ability.

4.2 CONSOLIDATION TEST

4.2.1 Test Specimens

The purpose of the tests conducted in this study was to compare the ability of metal and rubber vibrator heads to consolidate concrete specimens. A total of eight specimens were constructed for this test. The density and permeable void content of cores and the amount of air voids underneath reinforcing bars in each specimen were used to evaluate the quality of concrete consolidation. All reinforcing bars used in



Figure 4.2 Corrosion at blisters on coated bars

this test had a parallel rib, or bamboo, type deformation pattern. Both epoxy-coated and uncoated bars were used to attempt to identify any differences in concrete consolidation around coated versus uncoated bars.

The plan size of the concrete blocks was chosen based on the radius of influence reported for the heads used to consolidate them. In the arrangement shown in Figure 4.3, all of the concrete specimen is located within the vibrator's area of influence. The size of the specimens tested in this study were selected so that the area of the concrete block was located just inside the suggested radius of influence of the vibrator used to consolidate the specimen.

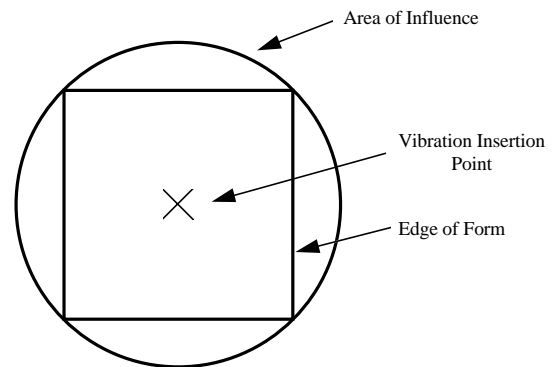

Figure 4.3 Area of influence and specimen size

Specimens M8 and R8 (Metal 8 in and Rubber 8 in)

The formwork and reinforcement for the first two specimens were identical. A photograph of the specimen formwork and reinforcement prior to vibration is shown in Figure 4.4. Both specimens were 205 mm (8 in) in height, 610 x 610 mm (24 x 24 in) in plan, and the layout of reinforcement in the specimens was as shown in Figure 4.5. As noted in the figure, all reinforcing bars in the two mats were 13 mm (#4) bars. Some reinforcing bars in each specimen were epoxy-coated, while others were uncoated.

Specimens M17 and R17

The next two specimens were also companion samples. These specimens were 430 mm (17 in) in height, 610 x 610 mm (24 x 24 in) in plan, and were reinforced as shown in Figure 4.6. Both 13 mm (#4) bars and 19 mm (#6) bars were used in the two reinforcement mats in these specimens. As shown in Figure 4.6, some bars were epoxy-coated, while others were uncoated.

Specimens M28 and R28

The third pair of companion specimens were 710 mm (28 in) in height, and 610 x 610 mm (24 x 24 in) in plan. The layout of reinforcement and specimen dimensions were as shown in Figure 4.7. Both 19 mm



Figure 4.4 Reinforcement of Specimens M8 and R8

(#6) bars and 25 mm (#8) bars were used in the three reinforcing mats in these specimens. As shown in the figure, some reinforcing bars were epoxy-coated while others were uncoated.

Specimens R18 and R30

The last two specimens were not companion specimens. Both specimens were 915 x 915 mm (36 x 36 in) in plan, but were of different heights. The first specimen was 460 mm (18 in) in height and had two reinforcement mats, while the second was 760 mm (30 in) in height and had three mats of reinforcement. The layout of reinforcement in these specimens is shown in Figures 4.8 and 4.9, respectively. In both of these specimens, all of the 16 mm (#5) bars were uncoated. Half of the 13 mm (#4) and 19 mm (#6) bars in specimen R18 were epoxy-coated, while the other half were uncoated. Similarly, half of the 19 mm (#6) and 25 mm (#8) bars in specimen R30 were epoxy-coated, while the other half were uncoated.

4.2.2 Test Procedure

All of the specimens were cast in Ferguson Structural Engineering Laboratory with concrete from the same ready-mix truck. Concrete was placed in each of the test specimen forms from an overhead bucket, as shown in Figure 4.10. Several different concrete vibrators were used during the consolidation of the test specimens. In all specimens the concrete vibrator was inserted at a single point in the plan center of the block. The vibrator head was inserted at the center point, and the concrete was vibrated for a specified period, after which the vibrator was removed. The surface of the specimens was then finished, and the blocks were allowed to cure for at least five days before coring began.

The length of vibration time for each pair of specimens was selected by observation of the concrete surface during vibration. First, a rubber head vibrator was inserted into one of the specimens, and the length of vibration was timed. The concrete was vibrated until the rapid escape of air bubbles subsided. The companion specimen was vibrated with the metal head for the same length of time.

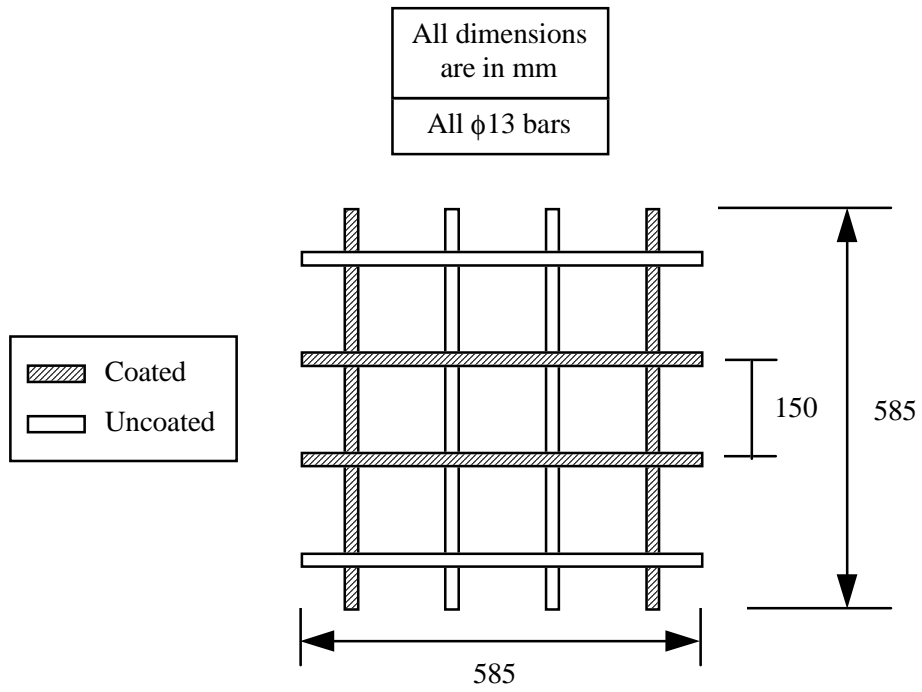

a) Reinforcement Mats

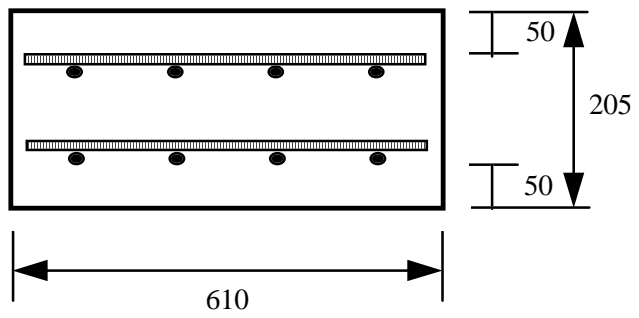

b) Side Elevation

Figure 4. 5 Layout of reinforcement in Specimens M8 and R8

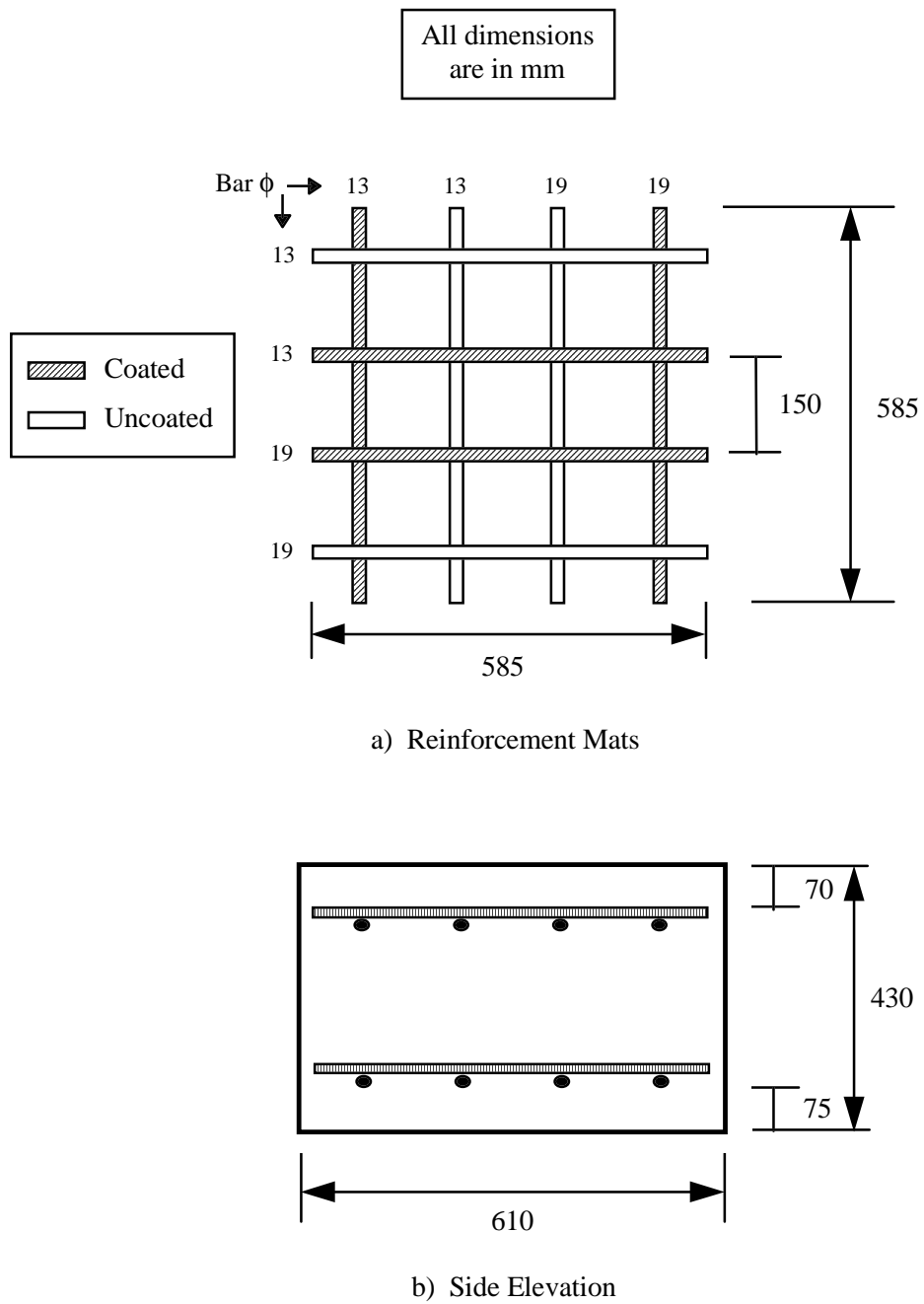
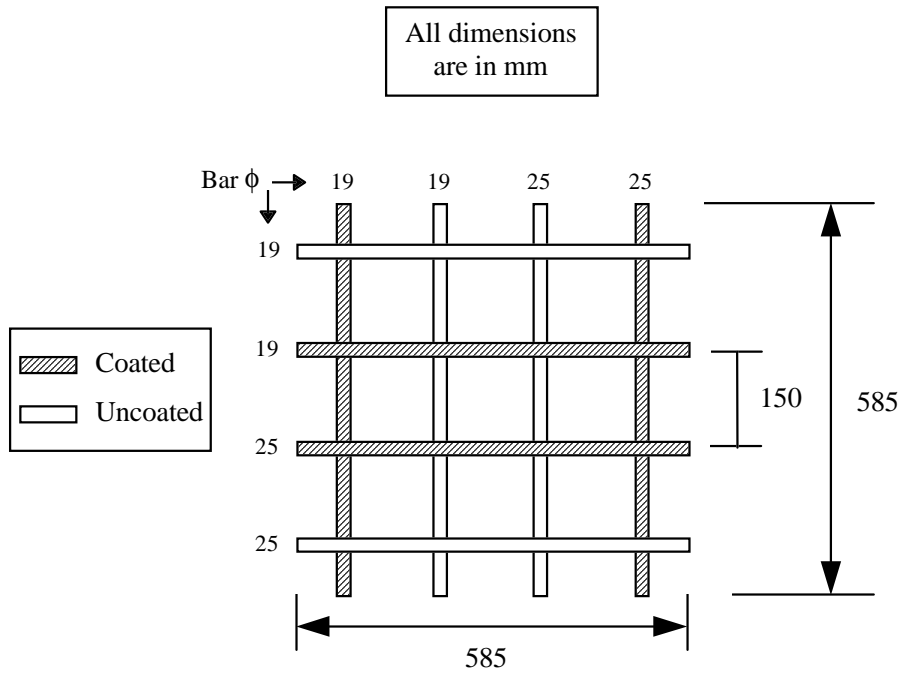
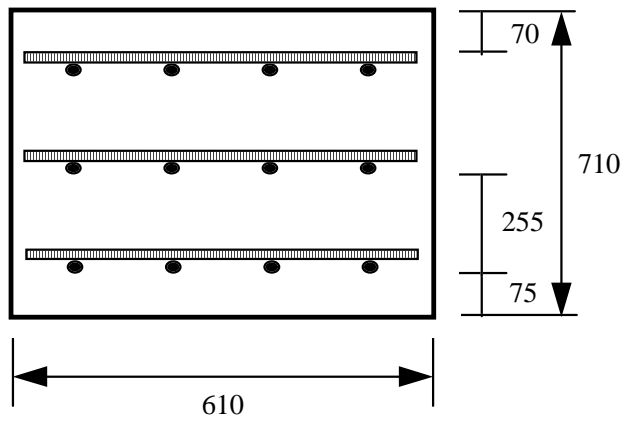

Figure 4. 6 Layout of reinforcement in specimens M17 and R17



a) Reinforcement Mats



b) Side Elevation

Figure 4.7 Layout of reinforcement in Specimens M28 and R28

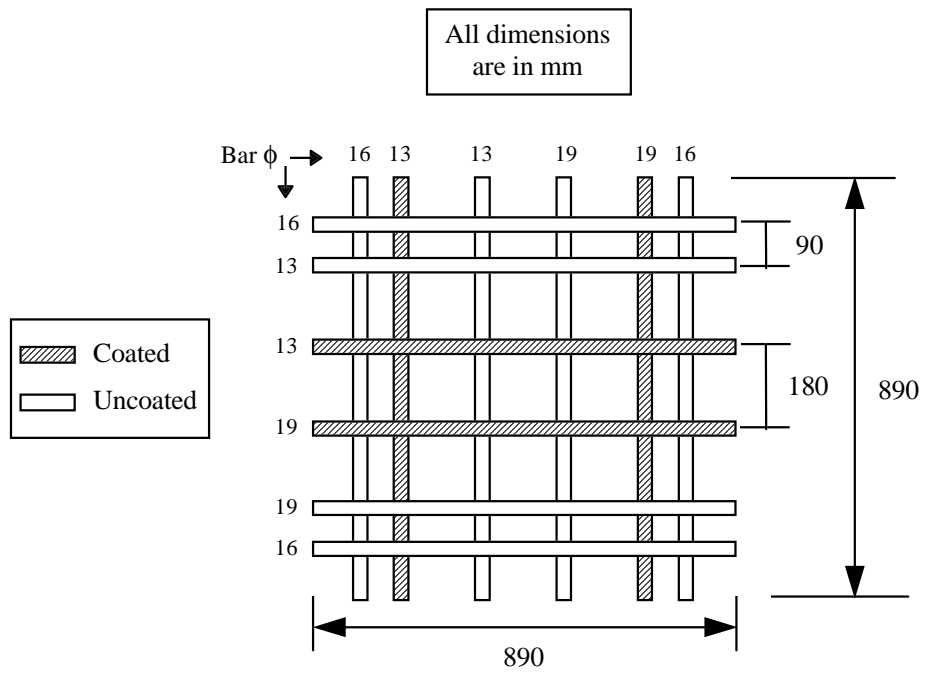

a) Reinforcement Mats

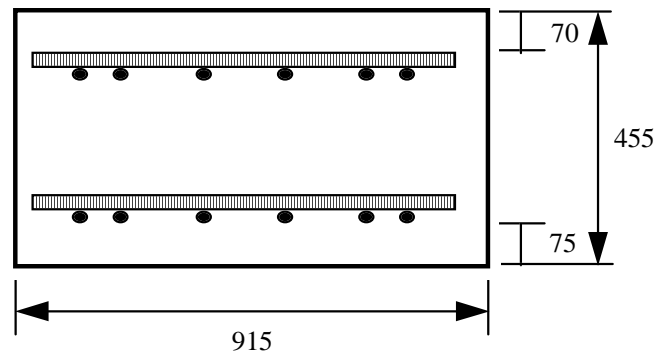

b) Side Elevation

Figure 4. 8 Layout of reinforcement in Specimen R18

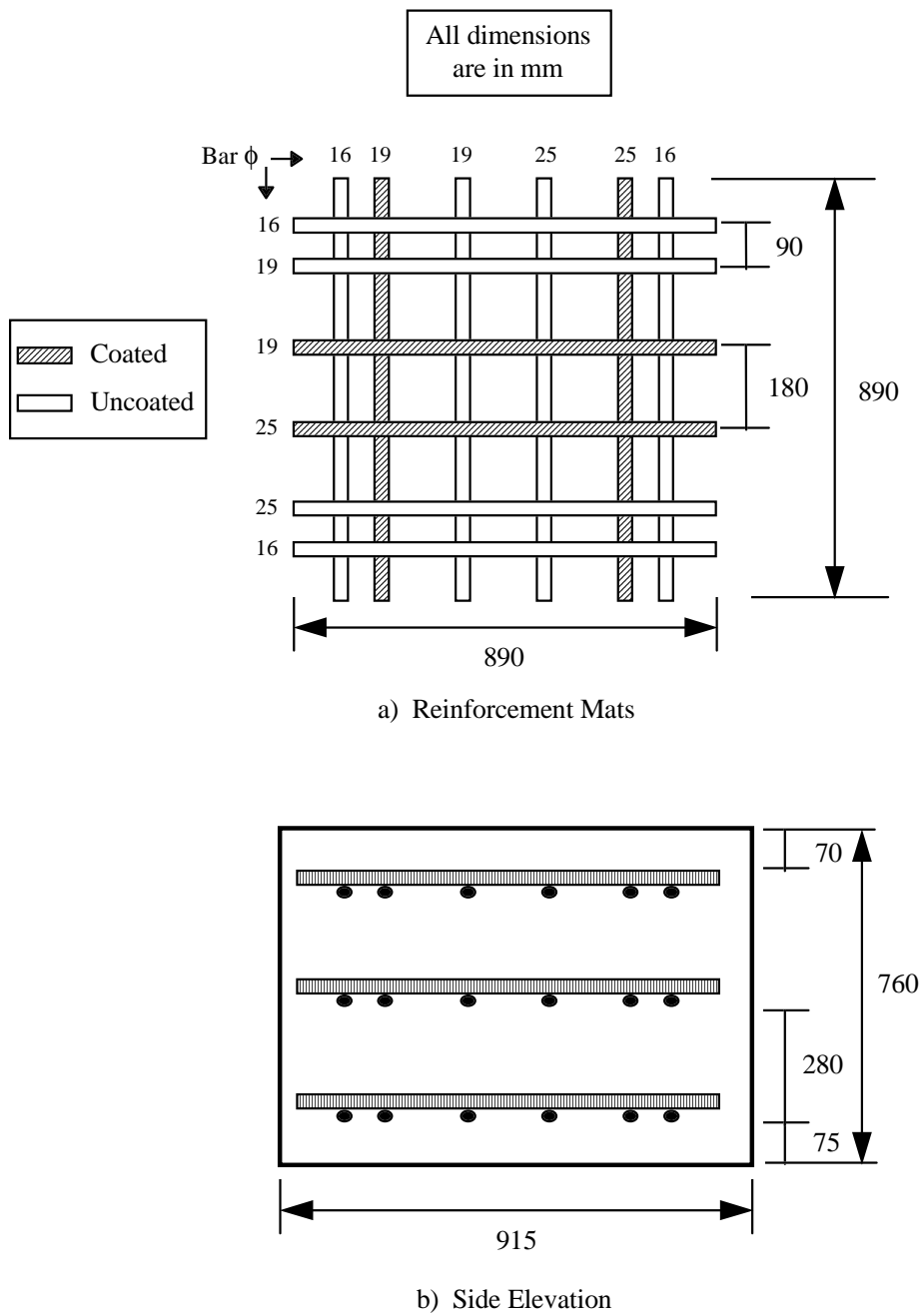

Figure 4. 9 Layout of reinforcement in Specimen R30



Figure 4. 10 Placing concrete in specimen from overhead bucket



Figure 4. 11 Consolidation of Specimen R8

Specimens M8 and R8

The first pair of specimens, 205 mm (8 in) in height, were vibrated with concrete vibrators with slab length heads. A picture of the vibration operation is shown in Figure 4.11. Specimen R8 was vibrated with a rubber head 70 mm (2 3/4 in) in diameter, and M8 was consolidated with a metal head vibrator which was 44 mm (1 3/4 in) in diameter. Both the metal and rubber heads were 230 mm (14 in) in length. The concrete was placed in the test specimens in a single lift, and the blocks were vibrated for eight seconds at the center insertion point.

Specimens M17 and R17

The second pair of specimens, 430 mm (17 in) in height, were consolidated with vibrator heads 360 mm (14 in) in length. The first specimen was consolidated with a rubber head 48 mm (1 7/8 in) in diameter. The second specimen was vibrated with a metal vibrator head 44 mm (1 3/4 in) in diameter. The concrete was placed in each block in two equal lifts. Both lifts were vibrated for eight seconds with the head positioned at the center insertion point. A picture of the vibration operation is shown in Figure 4.12.



Figure 4. 12 Consolidation of Specimen M17

Specimens M28 and R28

The third pair of specimens, 710 mm (28 in) in height, were also consolidated with the 360 mm (14 in) long vibrator heads. The metal head was 44 mm (1 3/4 in) in diameter, and the rubber head had a diameter of 48 mm (1 7/8 in). The concrete was placed in the block in three equal lifts. Each lift was vibrated for eight seconds, with the vibrator head at the center insertion point.

Specimens R18 and R30

The final two specimens, 915 x 915 mm (36 x 36 in) in plan, were both consolidated with a large rubber head vibrator. The rubber head was 70 mm (2 3/4 in) in diameter, and 380 mm (15 in) in length. The concrete in the shorter, 455 mm (18 in) tall block, was placed in two equal lifts. The concrete in the 760 mm (30 in) tall block was placed in three equal lifts. The concrete in each lift was vibrated for 15 seconds with the head at the center insertion point.

4.2.3 Coring Schedule

The concrete specimens were cored with a portable coring machine. A 98 mm (3 7/8 inch) bit was used for all cores. The coring machine is shown in operation in Figure 4.13. A total of thirty-seven cores were taken from the eight consolidation specimens. Figure 4.14 shows several cores after extraction from the concrete. Figure 4.15 is a picture of specimens M8 and R8 after coring. All but two of the cores were taken through specimen reinforcement. Nineteen of the cores were taken from specimens M8 and R8. Maps of the core locations in M8 and R8 are presented in Figure 4.16. A smaller number of core samples were taken from each of the other specimens.

All cores were split at the level of reinforcement so that the surface underneath each bar could be examined. Two cuts were made in the concrete on either side of each bar, and the core was then split as shown in Figure 4.17. The sections of bar were then removed from the core, as shown in Figure 4.18. A detailed evaluation was made of the concrete surface above and below each exposed reinforcing bar. The

number and size of air voids under each rebar section were recorded. The concrete surface above the reinforcing bars was also inspected. Sections were cut from cores of each specimen for density and void analysis. The density and void content of the hardened concrete was determined in accordance with ASTM C642 procedures.



Figure 4. 13 Coring reinforced concrete test specimen

4.3 TEST RESULTS

4.3.1 General Observations

The surface of the concrete surrounding each epoxy-coated bar was shiny and very smooth, as shown in Figure 4.19. There was no evidence of adhesion between the coated bars and the concrete. After removal from the cores, the epoxy-coated bars were clean with no concrete residue attached to them. The only remnant on some of the coated bars that gave an indication of their having been cast in concrete was a thin cement film where an air void was immediately adjacent to the bar. Films of this sort were not found at all junctures between air voids and reinforcing bars, only at certain locations near larger air voids.

Uncoated bars showed evidence of good adhesion with the surrounding concrete. At several locations, there were concrete fragments solidly attached to the black bars. The surface of the concrete surrounding uncoated bars had a dull



Figure 4. 14 Cores from consolidation test specimens

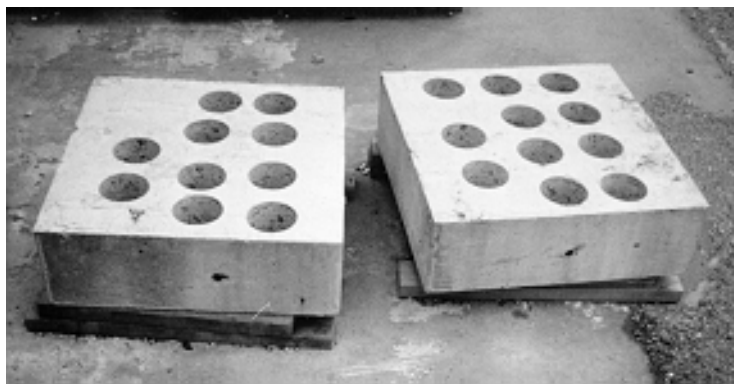
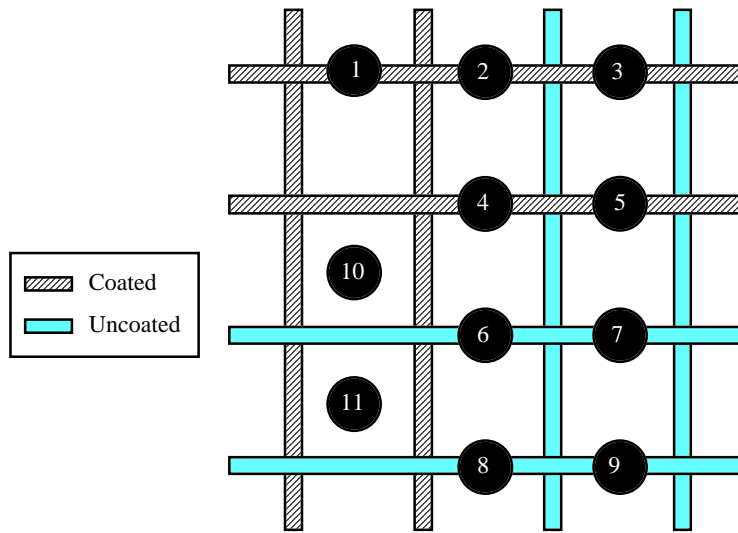
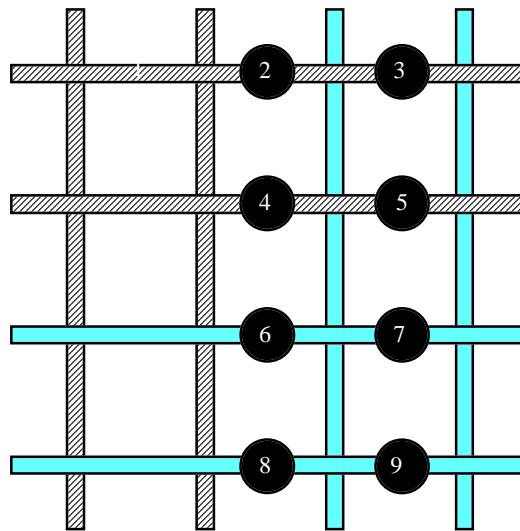

Figure 4. 15 Specimens M8 and R8 after coring



a) Coring Schedule for Specimen R8



a) Coring Schedule for Specimen M8

Figure 4. 16 Core maps for Specimens R8 and M8



Figure 4. 17 Splitting cores at level of reinforcement

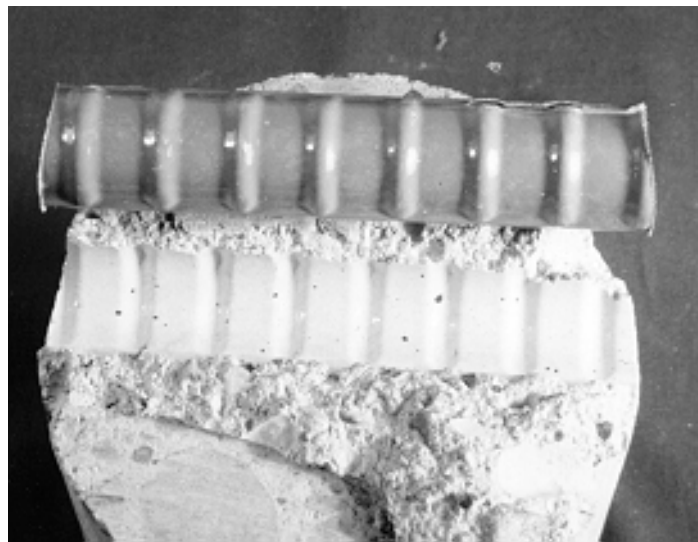

Figure 4. 18 Reinforcing bar extracted from core

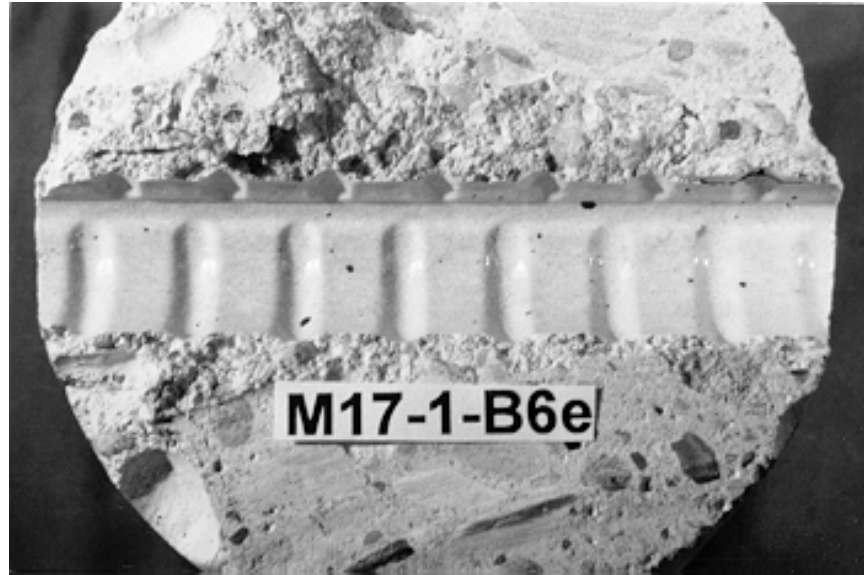

Figure 4. 19 Smooth and shiny surface under epoxy-coated rebar

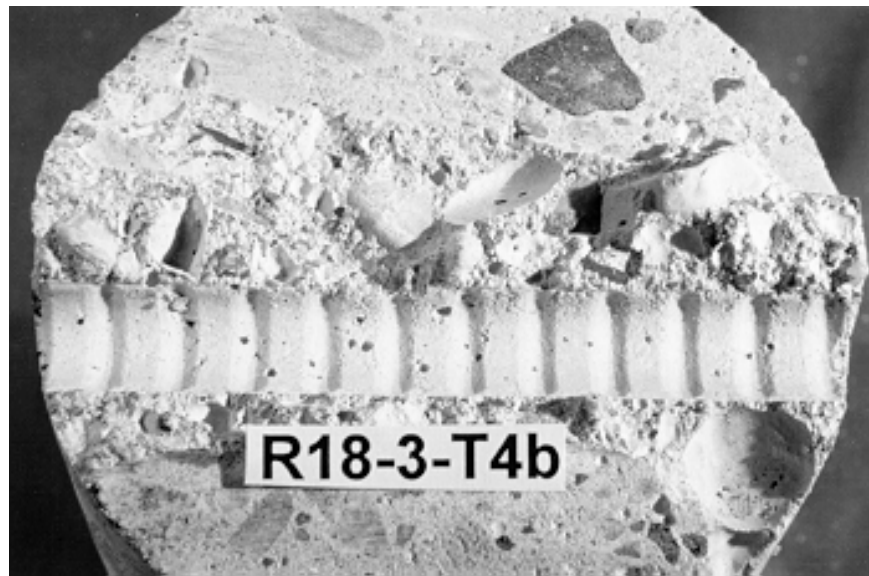

Figure 4. 20 Dull and rough surface under black rebar

appearance and was much rougher than that of concrete bordering epoxy-coated bars, as shown in Figure 4.20. Pieces of mill scale were separated from the black bars and were still in contact with the concrete. It was more difficult to split several of the cores at the level of the reinforcement when they were reinforced with uncoated bars versus coated ones. The increased difficulty of splitting the cores was likely due to the better adhesion between uncoated bars and the concrete.

4.3.2 Air Void Distribution

In almost all cases, there were no air voids adjacent to the top surface of reinforcing bars. There were voids in the concrete located beside and beneath most of the reinforcing bars, especially those farther from the point of vibrator insertion. Figure 4.21 shows typical small to medium sized voids located below a reinforcing bar. Voids were found at locations adjacent to both the side of the bar nearer the vibrator head and the side farther from the head. At locations where a bar rib was turned at an angle to the horizontal, there were often voids located on both sides of the rib. Figure 4.22 pictorially locates areas where voids were often located.



Figure 4. 21 Typical distribution of voids under rebar

Evaluation of the void area under bars in the eight specimens revealed several trends. First, there was more void area located under reinforcing bars in the upper mats of a specimen than in lower mats. The average void area under bars in the top mat varied from 1.6 to 4.8 times the void area under bars in the lower mats. Figure 4.23 shows the distribution of voids under bars in the upper and lower mats, respectively, from specimen R17. Note that the number and size of air voids under the upper bars is greater than that for the lower bars.

The fact that more void areas were observed under upper bars seems reasonable since, as the concrete continues to be vibrated, air voids rise towards the surface of the concrete. When vibration ceases, there are air voids that have risen up towards the top surface of a specimen but have not yet escaped the concrete. Subsequently, a larger amount of void area was located under the upper mat of reinforcement.

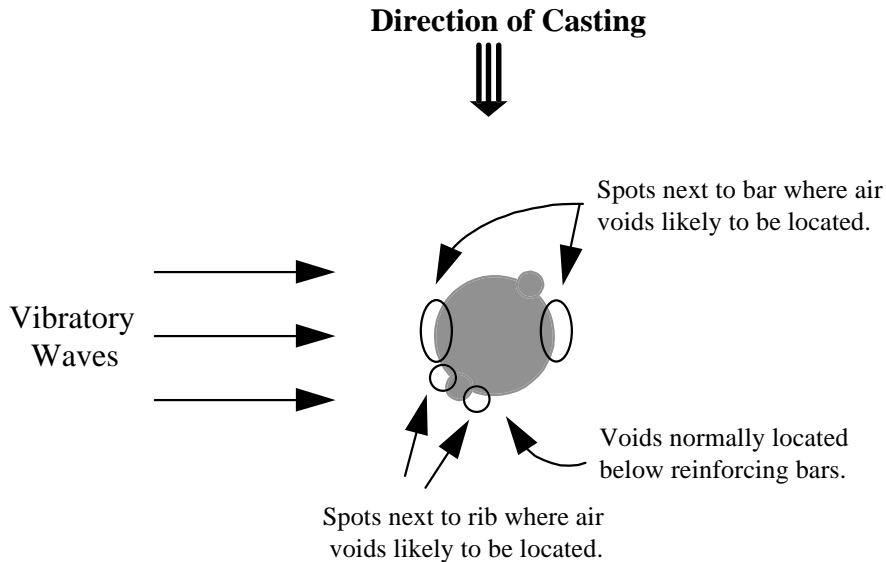

Figure 4. 22 Locations where voids were often located

Analysis of the air void distribution also showed larger void areas were located below bigger bars. Figure 4.24 shows the area of voids under a 25 mm (#8) bar in specimen M28. The occurrence of more void areas under larger bars seems quite logical since larger objects would be expected to interfere with the escape of entrained air bubbles more than smaller objects would. Subsequently, more air bubbles were trapped below bigger reinforcing bars.

Another trend, identified with both vibrator heads, is the variation in void area under reinforcing bars with distance from the point of vibrator insertion. In general, the area of voids under the reinforcement increases with distance from the point of vibrator insertion. This trend was seen with reinforcing bars in both upper and lower mats. The average void area under reinforcing bars close to the point of insertion was at most 70% of and as little as 5% of the void area under rebars farther from the point of insertion. Comparing a single bar close to the insertion point with the smallest number of voids, to a single bar far from the insertion point with a large number of voids, the close bar had only 2 to 17% of the void area of the far reinforcing bar. Figure 4.25 shows the voids under a bar close to and farther from the vibrator in the bottom mat of R8. Figure 4.26 shows close and far pictures for cores from the upper mat of specimen M8.

After cataloguing the void area under reinforcing bars in all of the specimens, no conclusive difference could be identified between the rubber and metal vibrator heads. At certain locations, use of the metal vibrator head resulted in the production of less void area under the reinforcement than did the companion rubber head. But at other locations, there was less void area with the rubber head. The nature of the average void area under reinforcing bars in the metal head specimens was not appreciably different than that of the companion rubber head specimens. Cores of Specimen R30, the 760 mm (30in) tall specimen vibrated with a large rubber head, did reveal very large void areas under reinforcing bars at two locations. However, the bars in question were large (25 mm, #8) bars and further coring of the specimens revealed locations in the specimens where the void area was much less significant. Furthermore, since there was no metal head companion to the large rubber vibrator head, no accurate comparison between specimens could be made. Thus, the large rubber head vibrator appears to consolidate the concrete around reinforcing bars as well as does the metal head.



(a) Air voids under top bar



(b) Air voids under bottom bar

Figure 4. 23 Voids under top and bottom bars from Specimen R17

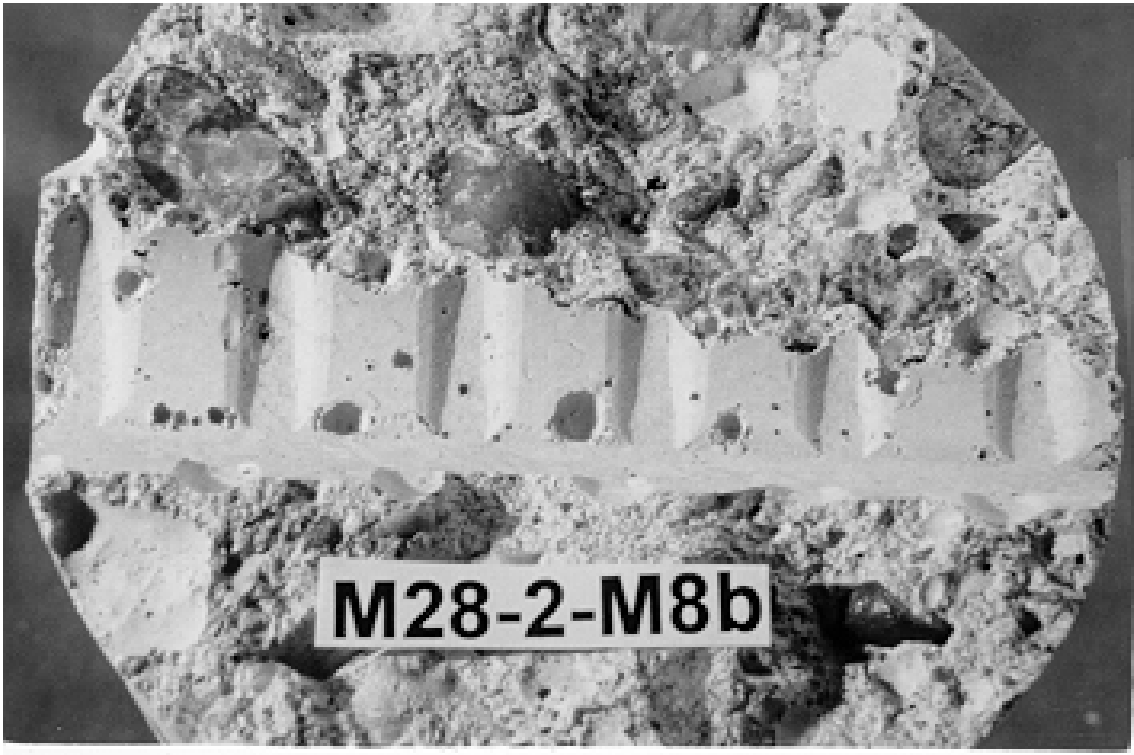
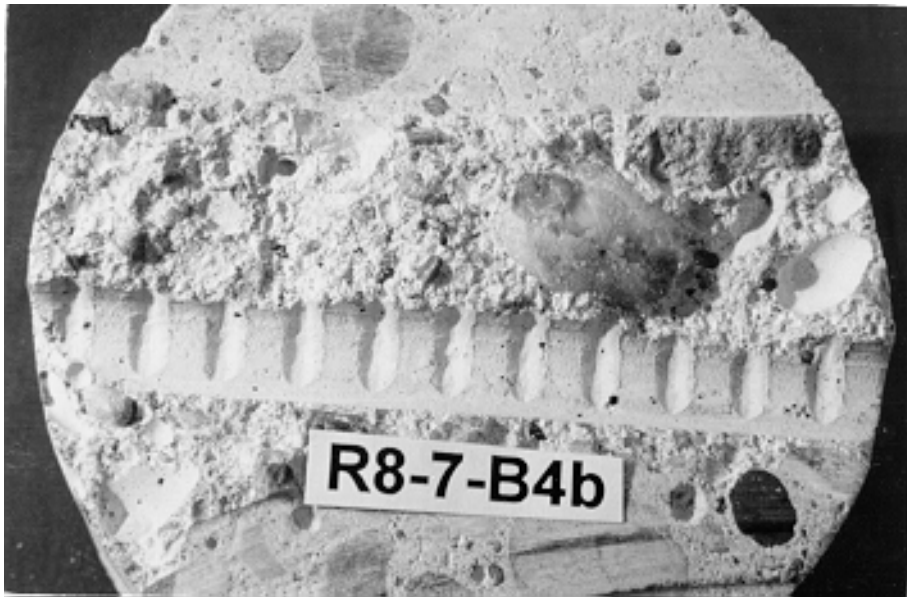
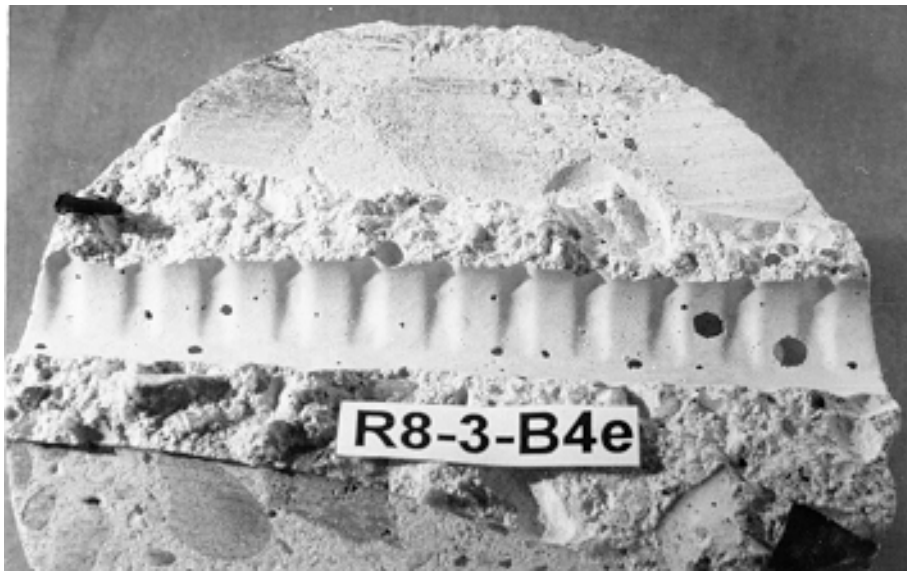

Figure 4. 24 Large voids under #8 rebar



(a) Air voids close to point of vibration insertion



(b) Air voids farther away from point of vibrator insertion

Figure 4. 25 Voids under bars from Specimen R8

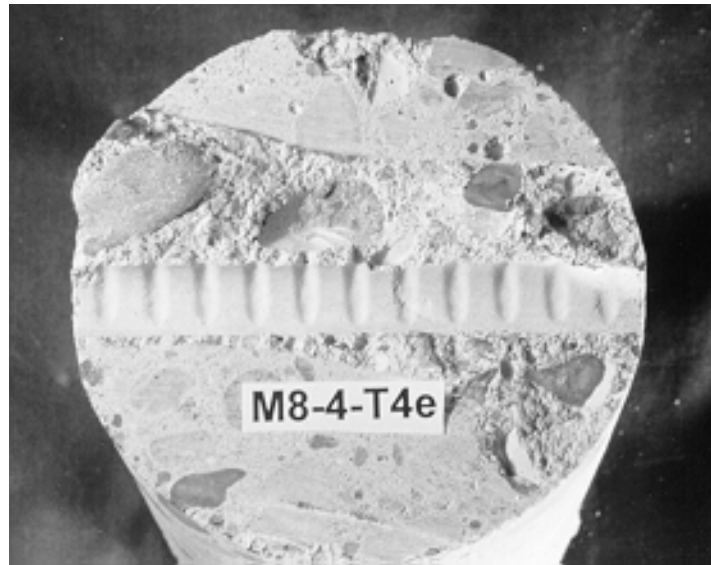

(a) Air voids close to point of vibrator insertion

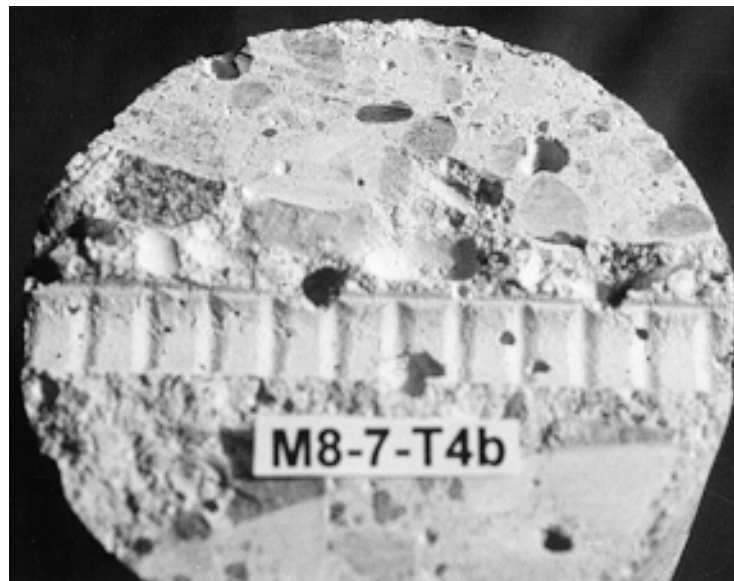

(b) Air voids farther from point of vibrator insertion

Figure 4. 26 Voids under bars from Specimen M8

No difference was seen between the void area beneath uncoated bars versus that beneath coated bars. At certain locations in a specimen, the area of voids beneath a black bar was less than that beneath the epoxy coated bars, but the situation was reversed at other places. Small and large voids were found under both epoxy-coated and uncoated bars from each specimen. Based on the limited database of specimens, no definitive difference in the consolidation of concrete around epoxy-coated bars versus uncoated bars was identified.

4.3.3 Concrete Density and Void Content

Sections were cut from cores of each of the specimens for determination of the concrete's density and permeable pore space. The test sections cut from the cores were at least 80 mm (several inches) from the top surface of the concrete, to ensure that surface finishing did not affect the results. All test sections were about the same distance (about 18 cm (7 in) to 20 cm (8 in)) from the point of insertion, and were from similar depths (8 cm (3 in) to 15 cm (6 in)) within the concrete blocks. The density of the concrete and the volume of permeable pore space were determined in accordance with ASTM C642.

The density and permeable void content of the rubber and metal head specimens were almost identical. There was only 2.3% difference between the largest and smallest test section densities. When the individual test section results were averaged and rounded, the density for all specimens

but Specimen M8 was 2370 kg/m³ (148 pcf). The density for Specimen M8 was 2385 kg/m³ (149 pcf). The similarity of these figures reveals that all of the specimens were consolidated to about the same degree, which was to a well consolidated state.

Table 4.1 Permeable Pore Space

Specimen	Volume of Permeable Pore Space (%)
R8	14.5
M8	13.4
R17	14.3
M17	13.9
R28	14.1
M28	14.3
R17	14.2
R30	14.0

The volume of permeable pore space for each of the specimens is presented in Table 4.1. In two of the three companion specimen pairs, the metal head block had less

permeable pore space. M8 had 7.6% less permeable voids than R8, and M17 had 2.8% less than R17. In the third companion pair, R28 had 1.4% less voids than M28. Overall, vibration with the metal heads seemed to produce less permeable void space than did vibration with the rubber head. Since the difference between the two heads was minimal and the test database is quite limited, results show no conclusive difference.

4.4 DISCUSSION OF RESULTS

No systematic difference was seen in concrete consolidation around epoxy-coated bars versus uncoated bars. It was noted that larger void areas were located beneath bars in the upper mat of reinforcement than were found under bars in lower mats. There will always be entrapped air in concrete when it is placed in the form, and this air will rise to the surface of the concrete as it is vibrated. It is not realistic, however, to attempt to remove all entrapped air, since excessive vibration may cause segregation of the concrete. Thus, air will remain in the concrete after vibration, particularly where it is trapped beneath objects like reinforcing bars.

A factor that seemed to result in more air voids being positioned beneath upper mats in this study is the placement of concrete in lifts. If concrete is placed in two lifts, the bottom lift is traditionally adequately vibrated, and then a second lift is placed on top of it. During the vibration of the second lift, the head of the vibrator should be inserted several centimeters (a few inches) into the preceding lift. Subsequently, the first lift receives additional vibration during the consolidation of the top lift. Entrapped air bubbles in the first lift, near lower reinforcement mats, have a second opportunity to escape. Air bubbles in the top lift, however, do not have this advantage. And since the top mat of reinforcement is often located within several centimeters (a few inches) of the top surface of the concrete, more air bubbles are left trapped in the vicinity of the upper mat.

Since the penetration of chlorides into concrete is often a top down operation, particularly in bridge decks, voids beneath the top mat of reinforcement will be the first ones encountered. Since reinforcing bars with voids located beneath them have been shown to perform poorly, it would be advantageous to ensure the bars in the top mat, as well as those in the other mats, have as few voids beneath them as possible. Since it has been shown that there are generally more voids located beneath the top layer of reinforcement, it would be advisable to vibrate the top lift of the concrete, or the whole depth if the concrete is cast in one lift, for longer periods to ensure air bubbles have sufficient time to escape. Additionally, inserting the vibrator at more points in the concrete, on a closer spaced interval, should help to remove the air bubbles from beneath the top mat.

As noted, the density and permeable void content for specimens vibrated with the two different heads were very similar. The permeable pore space was, on average, less with the metal head than with the rubber head, but only slightly so. Therefore, both heads produced specimens that were consolidated to about the same degree.

4.5 CONCLUSIONS

More void areas are located under reinforcing bars farther from the point of vibration insertion than closer to the insertion point, even when the concrete at both locations is adequately consolidated. A certain schedule of vibration insertions may adequately consolidate the concrete in a given area, but the void area under bars at the edge of the area of influence may be unacceptable. Thus, the radius of influence for adequate consolidation of concrete may be larger than the radius of influence for removal of air voids beneath reinforcing bars. A closer schedule of insertions seems to be required to ensure adequate removal of air voids from beneath reinforcing bars than is required for consolidation of the concrete.

Taking the area of influence for removal of void area beneath bars as 75% of that required for concrete consolidation seems to be adequate. With this reduced area of influence, the schedule of vibrator insertions will be increased. With the closer spacing of insertion points, the average void area under reinforcing bars should be reduced, particularly for those bars on the fringes of the influence area. The reduction of void area under bars means there will be fewer places where water can collect in close proximity to the reinforcement, and as previously discussed, the corrosion performance of the bars should be improved. Though a larger spacing of insertion points may adequately consolidate a concrete specimen, a closer schedule of insertions may be required to ensure that void areas under bars are removed.

The results of this study show that rubber vibrator heads have the ability to produce well consolidated concrete. Concrete specimens were vibrated with rubber heads until the rapid exit of air bubbles had

ceased. Companion specimens were vibrated with metal vibrator heads for equivalent periods of time. Both the rubber and metal heads produced concrete that was adequately consolidated. Both heads removed the large entrapped air bubbles from the concrete and the density and permeable pore space was similar for specimens vibrated with each of the heads. Thus, it has been shown that the rubber vibrator heads can produce adequately consolidated concrete with a density comparable to that produced using a metal head.

An investigation of concrete consolidation as a function of vibration time was not performed in this study, but based on the results of Chapter 3, longer periods of vibration will likely be required to consolidate a specimen with a rubber vibrator head than with a metal head. This study shows, however, that when concrete is sufficiently vibrated with a rubber head, i.e. until good consolidation is observed visually, the rubber vibrator head can produce adequately consolidated concrete. Based on ACI and PCA guidelines for times of vibration required to consolidate concrete specimens, the period of vibration required with the rubber heads was not excessive. Subsequently, the rubber heads are considered satisfactory in their ability to produce well consolidated concrete.

CHAPTER 5

SUMMARY, CONCLUSIONS, AND RECOMMENDATIONS

5.1 SUMMARY

The main objective of this study was to investigate the use of soft, rubber vibrator heads for consolidation of concrete reinforced with epoxy-coated bars. The rubber heads were appraised alongside typical metal vibrator heads and their relative performance was compared. The vibrator heads were evaluated based on 1) the amount of damage done to coated bars during concrete placement, 2) measurements of the vibrator action in fresh concrete during consolidation, and 3) analysis of cores from hardened concrete after consolidation.

5.1.1 Damage to Epoxy Coating

Several test specimens were constructed in this investigation to aid in evaluating vibrator damage to coated reinforcing bars. Companion specimen pairs simulating column, footing, and slab sections were assembled. One specimen was vibrated with the rubber vibrator head, while the metal head was used to consolidate the companion specimen. The amount of vibrator damage to each specimen's reinforcement was assessed in a thorough visual examination procedure. The extent of damage for each vibration test specimen with each of the heads was tabulated and results for the two types of heads were compared.

For each of the specimen types, the rubber vibrator head did less damage than did the metal head. The amount of damage with the metal head was, in some instances, over five times that done with the rubber head. Generally, the average amount of damage with the metal vibrator head was almost three times that done with the rubber head. Additionally, the largest single damaged area on each specimen's reinforcement was greater, in almost every case, with the metal head than with the rubber head. Thus, based on all normal measures of damage, the metal vibrator heads produced significantly more damage than did their rubber head companions.

5.1.2 Measurement of Vibration in Fresh Concrete

In this test, companion specimens were vibrated with a rubber and metal vibrator head, respectively, as accelerometers recorded the vibratory action in the concrete. The measurements taken in this study showed that during the consolidation of the specimens, the metal head produced more significant horizontal waves in the concrete than did the rubber head. Horizontal particle accelerations with the metal head were greater than those with the rubber head, both close to the insertion point of the vibrator, and farther out from this point. More significant differences were noted between the two heads at points farther from the point of insertion.

It was also observed that the frequency in the concrete during vibration was about 10% less with the rubber head than with the metal head, but that vertical particle accelerations were greater with the rubber head than with the metal head. The larger vertical accelerations produced with the rubber head are attributed to the physical characteristics of the rubber head.

5.1.3 Evaluation of Consolidation in Hardened Concrete

Several sets of companion specimens were prepared for consolidation with a variety of metal and rubber vibrator heads. The specimens were allowed to cure and harden after vibration, and then were cored. Cores from both metal and rubber head specimens revealed that more voids are located under reinforcing bars farther from the point of vibration insertion than there are closer to the insertion point, even when the concrete at both locations is adequately consolidated. The cores also showed more voids under the upper mat of reinforcement in each specimen than were located beneath lower mats.

Both the rubber and metal heads produced concrete that was adequately consolidated. Both heads removed the large entrapped air bubbles from the concrete and the density and permeable pore space was similar for specimens vibrated with each of the heads.

5.2 CONCLUSIONS

Rubber vibrator heads did less damage to coated reinforcement than did comparable metal heads. Under similar conditions and with the same period of vibration, metal heads produced more significant percentages of damage on a coated bar and larger damaged spots than a rubber vibrator head. Based on damage to epoxy-coated reinforcement, rubber vibrator heads are highly recommended over typical metal heads.

With both metal and rubber heads, longer periods of vibration and tighter clearances will result in the production of more damage to the coated bars. Direct contact between either head and a coated bar for even very short periods can result in significant damage to the epoxy coating.

Metal vibrator heads produced more significant horizontal accelerations than do companion rubber heads, especially at larger distances from the point of insertion. The area of influence with a metal vibrator head was larger than that of a comparable rubber head, and the concrete was more efficiently, and rapidly, consolidated with the metal head. However, with sufficient periods of vibration and appropriate spacings of insertion points, a rubber vibrator head can sufficiently consolidate concrete.

Based on results of consolidation tests with both metal and rubber heads, it was found that more voids were located under reinforcing bars farther from the point of vibration insertion than there were closer to the insertion point, even when the concrete at both locations was adequately consolidated. The radius of influence for adequate consolidation of concrete thus may be larger than the radius of influence for removal of air voids beneath reinforcing bars. A closer schedule of insertions seems to be required to ensure adequate removal of air voids from beneath reinforcing bars than is required for consolidation of the concrete. A reduction in air voids under bars should correlate with improved corrosion performance, as there will be fewer places for water and corrosive elements to collect in close proximity to the reinforcement.

5.3 RECOMMENDATIONS

Rubber vibrator heads should be specified for consolidation of concrete with epoxy-coated reinforcement. The use of rubber heads will result in the production of less damage to coated reinforcement, while adherence to proper vibration procedures will ensure the concrete is adequately consolidated.

With both metal and rubber vibrator heads, the radius of influence for adequate consolidation may be larger than that for removal of air voids beneath reinforcement. Taking the area of influence for removing air voids as 75% of that required for consolidation seems to be adequate. The subsequent increase in the schedule of vibrator insertions will help to ensure that air voids beneath bars are adequately removed and that the concrete is well consolidated. The reduction in insertion point spacings should not have adverse affects, so long as the operator follows proper procedures and is careful to avoid overvibrating the concrete. With the use of rubber vibrator heads, the level of damage to the coated bars should not be significantly worsened with the increased schedule of insertion points.

Vibrator operators should be well trained in proper consolidation procedures, especially when the concrete is reinforced with epoxy-coated bars. Operators should not deliberately contact coated reinforcement with either metal or rubber heads, and they should avoid cursory contact between the vibrating head and reinforcing bars. The vibrator should not be dragged over coated bars, nor should the head be forced into tight areas between a coated reinforcement cage and formwork. Operators should be instructed on proper spacings of insertion points for concrete vibrators, and special care should be taken to ensure concrete reinforced with epoxy-coated reinforcement is adequately consolidated.

Since concrete placement is the last possible procedure during which the coating on reinforcement can be damaged before it is put into service, and since damage during concrete placement cannot be seen nor repaired, it is important that all possible means be used to limit vibrator induced damage. Furthermore, since the quality of concrete consolidation has substantial impact on the corrosion performance of epoxy-coated reinforcement, it is also important to ensure that the concrete in place is well consolidated. The proper use of rubber vibrator heads, with a sufficient schedule of insertion points, should result in the manufacture of the best possible product of concrete reinforced with epoxy-coated bars.

APPENDIX

CONCRETE MIX SPECIFICATIONS

CONCRETE USED IN COLUMN DAMAGE TEST

COMPONENT	WEIGHT (lb)
Sand	4594
3/4 in Rock	5915
1 1/2 in Rock	2597
Cement	1432
Fly Ash	166
Water	320
Pozzolan	70 oz
Air	8 %

NOTE: Additional 64 oz of superplasticizer added on site.

Cylinder Compressive Strength at 28 days = 1170 psi

CONCRETE USED IN FOOTING DAMAGE TEST

COMPONENT	WEIGHT (lb)
Sand	6520
3/4 in Rock	5760
1 1/2 in Rock	3640
Cement	2050
Fly Ash	660
Water	384
Pozzolan	100

Note : Additional 10 gallons of water added on site.

Cylinder Compressive Strength at 28 days = 5630 psi

CONCRETE USED IN SLAB DAMAGE TEST AND HARDENED CONCRETE CONSOLIDATION TEST

COMPONENT	WEIGHT (lb)
Sand	7461
3/4 in Rock	9422
Cement	1350
Fly Ash	400
Water	459
Pozzolan	53 oz

Note: Additional 10 gallons of water added on site.

Cylinder Compressive Strength at 28 days = 3360 psi

CONCRETE USED IN CONSOLIDATION TEST IN FRESH CONCRETE

COMPONENT	WEIGHT (lb)
Sand	4920
3/8 in Rock	6060
Cement	2145
Water	322
Pozzolan	130

Note: Additional 15 gallons of water added on site.

Cylinder Compressive Strength at 28 days = 6350 psi

BIBLIOGRAPHY

1. Jones, Denny A., *Principles and Prevention of Corrosion*, Macmillan Publishing Company, New York, New York, 1992.
2. Zayed, Abla M., and Sagues, Alberto A., "Corrosion of Epoxy-Coated Reinforcing Steel in Concrete," Paper No. 379, *Corrosion 89*, NACE, New Orleans Convention Center, New Orleans, Louisiana, April 17-21, 1989, 20 p.
3. Sagues, Alberto A., "Corrosion of Epoxy-Coated Rebar in Florida Bridges," Final Report, State Job No. 99700-7556-010, University of South Florida, Tampa, Florida, May 1994, 70 p.
4. Kahhaleh, Khaled Zuhair, *Corrosion Performance of Epoxy-Coated Reinforcement*, doctoral dissertation, The University of Texas at Austin, May 1994.
5. Kahhaleh, K. Z., Chao, H. Y., Jirsa, J. O., Carrasquillo, R. L., and Wheat, H. G., "Studies on Damage and Corrosion Performance of Fabricated Epoxy-Coated Reinforcement," Report No. FHWA/TX-93+1265-1, National Technical Information Service, Springfield, VA, January 1993, 80 p.
6. *OZTEC Damage-Free Epoxy Coated Rebars*, *Oztec Industries Document*.
7. ACI Committee 309, "Guide for Consolidation of Concrete," ACI 309R-87, *ACI Manual of Concrete Practice*.
8. Supernant, Bruce A., "Concrete Vibration: The Why and How of Consolidating Concrete," *Concrete Construction*, June 1988, pp 563-567.
9. Forssblad, Lars, and Sallstrom, Stig, "Concrete Vibration—What's Adequate?," *Concrete International*, September 1995.
10. Kosmatka, Steven H., and Panarese, William C., *Design and Control of Concrete Mixtures*, 13th ed., Portland Cement Association, Skokie, Illinois, 1988.
11. ACI Committee 309, "Behavior of Fresh Concrete During Vibration," ACI 09. 1 R- 8 I, *ACI Manual of Concrete Practice*.
12. Mindess, Sidney, and Young, J. Francis, *Concrete*, Prentice-Hall, New Jersey.
13. Texas Department of Transportation, *Standard Specifications for Construction of Highways, Streets and Bridges*, TXDOT, March 1, 1993.
14. ACI Committee 309, "Identification and Control of Consolidation-Related Surface Defects in Formed Concrete," ACI 309.2R-90, *ACI Manual of Concrete Practice*.
15. *OZTEC Rubber Heads*, Rubber Covered Concrete Vibrators Specification Document.

16. Chao, Heng-Yin, *Determination of Damage to Epoxy Coating of Reinforcement During Construction and Fabrication*, master's thesis, The University of Texas at Austin, August 1992.
17. Korman, Richard, "Agencies Adjust to Rebar Realities," *Engineering News Record*, February 21, 1994.
18. Smith, L. L., Kessler, R. J., and Powers, R. G., "Corrosion of Epoxy-Coated Rebar in a Marine Environment," Transportation Research Circular: Epoxy-Coated Reinforcement in Highway Structures, No. 403, ISSN 0097-8515, National Research Council, Washington, D. C., March 1993, pp 36-45.
19. Mathey, Robert G., and Clifton, James R., "Corrosion Resistant Epoxy-Coated Reinforcing Steel," *Structures Congress MI*, Volume 1, American Society of Civil Engineers, Atlanta, GA, April 24-28, 1994, pp 109-115.
20. Sagues, A. A., and Powers, R. G., Effect of Concrete Environment on the Corrosion Performance of Epoxy-Coated Reinforcing Steel, Paper No. 31 1, *Corrosion 90*, NACE, Bally's Hotel, Las Vegas, Nevada, April 23-27, 1990, 15 p.
21. McKenzie, Malcolm, "The Effect of Defects on the Durability of Epoxy-Coated Reinforcement," Transportation Research Circular: Epoxy-Coated Reinforcement in Highway Structures, No. 403, ISSN 0097-8515, National Research Council, Washington, D.C., March 1993, pp 17-28.
22. Clear, Kenneth C., "Effectiveness of Epoxy-Coated Reinforcing Steel (C-SBRP Report: Executive Summary)," Transportation Research Circular: Epoxy-Coated Reinforcement in Highway Structures, No. 403, ISSN 0097-8515, National Research Council, Washington, D.C., March 1993, pp 66-67.
23. Schiessl, Peter, and Reuter, Carola, "Epoxy-Coated Rebars in Europe: Research Projects, Requirements and Use," Transportation Research Circular: Epoxy-Coated Reinforcement in I-highway Structures, No. 403, ISSN 0097-8515, National Research Council, Washington, D. C., March 1993, pp 29-35.
24. Sagues, Alberto A., "Evaluation of Corrosion Rate by Electrochemical Impedance in a System with Multiple Polarization Effects," Paper No. 25, *Corrosion 89*, NACE, New Orleans Convention Center, New Orleans, Louisiana, April 17-21, 1989 10 p.
25. Erdogdu, Sakir, and Bremner, Theodore W., "Field and Laboratory Testing of Epoxy-Coated Reinforcing Bars in Concrete," Transportation Research Circular: Epoxy-Coated Reinforcement in I-highway Structures, No. 403, ISSN 0097-8515, National Research Council, Washington, D.C., March 1993, pp 5-16.
26. Concrete Reinforcing Steel Institute, "Guidelines for Inspection and Acceptance of Epoxy-Coated Reinforcing Bars at the Job Site," CRSI, Schaumburg, Ill, 1986.

27. Kahhaleh, K. Z., Jirsa, J. O., Carrasquillo, R. L., and Wheat, H. G., "Macrocell Corrosion Study of Fabricated Epoxy-Coated Reinforcement," *International Conference on Corrosion and Corrosion Protection of Steel in Concrete*, University of Sheffield, July 24-29, 1994, 19 p.
28. Sagues, Alberto, Powers, Rodney, and Zayed, Abla, "Marine Environment Corrosion of Epoxy-Coated Reinforcing Steel," *Corrosion of Reinforcement in Concrete*, C. Page, K. Treadway and P. Bamforth, eds., Elsevier Applied Science, London-New York, 1990, pp 539-550.
29. Pfeifer, Donald W., Landgren, Robert, and Krauss, Paul, "Performance of Epoxy-Coated Rebars: A Review of CRSI Research Studies," *Transportation Research Circular: Epoxy-Coated Reinforcement in Highway Structures*, No. 403, ISSN 0097-8515, National Research Council, Washington, D.C., March 1993, pp 57-65.
30. McDonald, D. B., Sherman, M. R., and Pfeifer, D. W., "The Performance of Bendable and Nonbendable Organic Coatings for Reinforcing Bars in Solution and Cathodic Debonding Tests," Publication No. FHWA-RD-94-103, U.S. Department of Transportation, January 1995, 148 pp.
31. Clear, Kenneth C., "Effectiveness of Epoxy-Coated Reinforcing Steel Interim Report," *Canadian Strategic Highway Research Program*, August 1990, 94 pp.
32. Zayed, Abla M., and Sagues, Alberto A., "Corrosion at Surface Damage on an Epoxy-Coated Reinforcing Steel," *Corrosion Science*, Vol. 30, No. 10, pp 1025-1044, 1990.