

<b>1. Report No.</b> FHWA/TX-92+1210-2	<b>2. Government Accession No.</b>	<b>3. Recipient's Catalog No.</b>	
<b>4. Title and Subtitle</b> SHEAR STRENGTHENING OF PRETENSIONED PRESTRESSED CONCRETE COMPOSITE FLEXURAL MEMBERS		<b>5. Report Date</b> March 1991	<b>6. Performing Organization Code</b>
<b>7. Author(s)</b> R. Aboutaha and N. Burns		<b>8. Performing Organization Report No.</b> Research Report 1210-2	
<b>9. Performing Organization Name and Address</b> Center for Transportation Research The University of Texas at Austin Austin, Texas 78712-1075		<b>10. Work Unit No.</b>	<b>11. Contract or Grant No.</b> Research Study 3-5-89/1-1210
<b>12. Sponsoring Agency Name and Address</b> Texas State Department of Highways and Public Transportation; Transportation Planning Division P. O. Box 5051 Austin, Texas 78763-5051		<b>13. Type of Report and Period Covered</b> Interim	
<b>15. Supplementary Notes</b> Study conducted in cooperation with the U. S. Department of Transportation, Federal Highway Administration. Research Study Title: "Influence of Debonding of Strands on the Behavior of Composite Prestressed Beams"		<b>14. Sponsoring Agency Code</b>	
<b>16. Abstract</b> <p>Strengthening is required due to inadequacy which typically results from a poor design, a change in usage, or a change in design loads. Prestressed composite beams require special attention in connection with their behavior in horizontal shear at the composite interface. Beams lacking adequate shear reinforcement experience brittle shear failure unless they have low flexural stiffness. Such beams can be strengthened so that they can develop their flexural capacity and behave in a more ductile manner at failure.</p> <p>External post-tensioning system is often a desirable strengthening solution when a major portion of a member must be strengthened or when the cracks which have formed must be closed. This research work studies the behavior of retrofitted prestressed composite beams that originally lacked shear reinforcement and have a smooth interface bonded with epoxy. Before retrofitting these beams experienced sudden horizontal shear failure. Ductile flexural failure occurred after being retrofitted by external prestressing bars. This research studied how the mode of failure of prestressed composite flexural member could be changed from a sudden shear failure to a ductile flexural failure by utilizing external prestressing bars. It studied the effect of these prestressing bars on the required development length of prestressing strands. The provisions of ACI Code 318-89 for the design of prestressed concrete composite beams were compared with the test results. Recommendations are made for the use of external prestressing systems as an effective strengthening procedure.</p>			
<b>17. Key Words</b> shear, strengthening, prestressed concrete, composite concrete beams, horizontal shear, external post-tensioning, development length		<b>18. Distribution Statement</b> No restrictions. This document is available to the public through the National Technical Information Service, Springfield, Virginia 22161.	
<b>19. Security Classif. (of this report)</b> Unclassified	<b>20. Security Classif. (of this page)</b> Unclassified	<b>21. No. of Pages</b> 98	<b>22. Price</b>

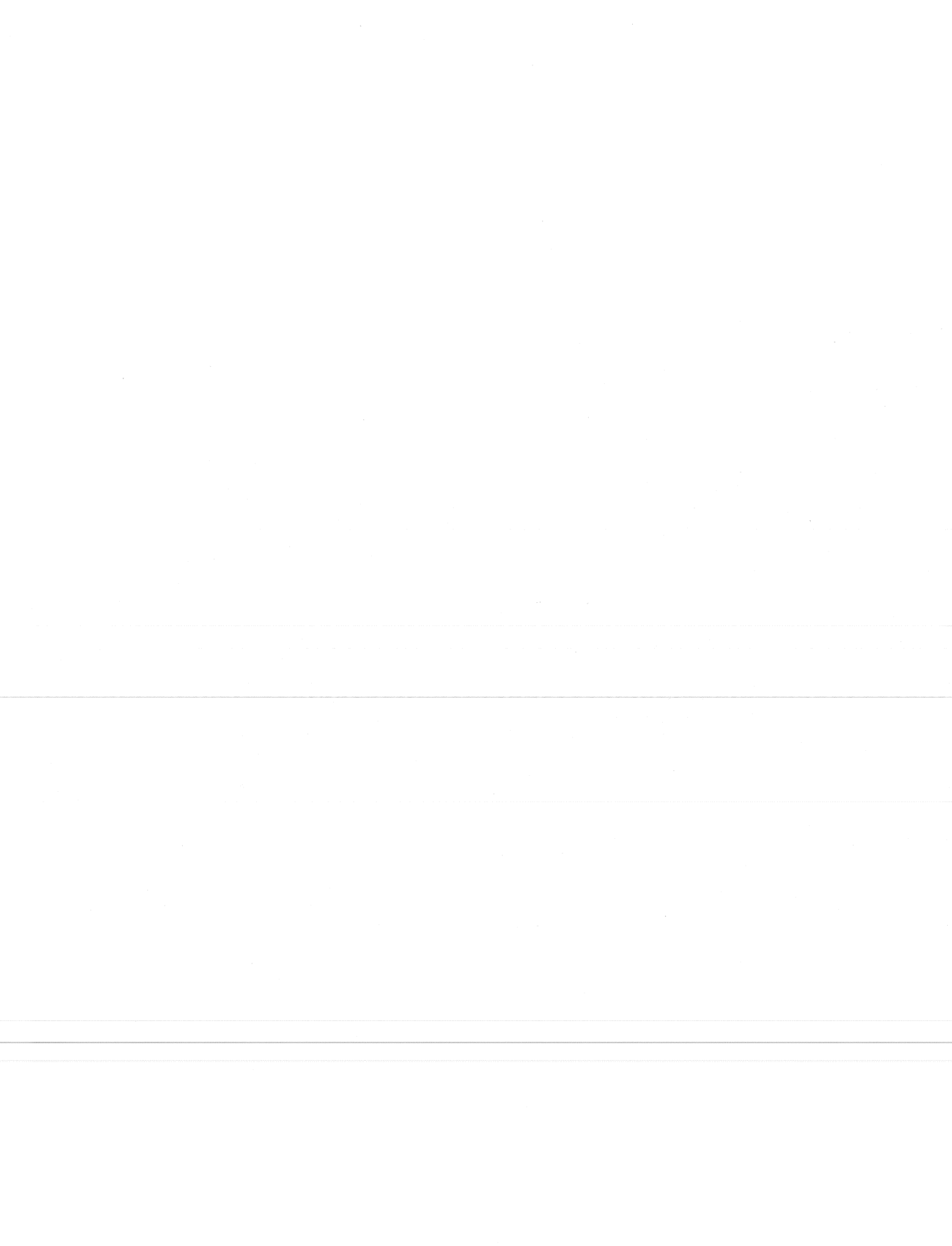

**SHEAR STRENGTHENING OF PRETENSIONED PRESTRESSED  
CONCRETE COMPOSITE FLEXURAL MEMBERS**

by

**R. Aboutaha and N. Burns**

**Research Report 1210-2**

**Research Project 3-5-89-1210**

**"Influence of Debonding of Strands on Behavior of Composite  
Prestressed Beams"**

**Conducted for**

**Texas**

**State Department of Highways and Public Transportation**

**In Cooperation with the**

**U.S. Department of Transportation  
Federal Highway Administration**

by

**CENTER FOR TRANSPORTATION RESEARCH  
BUREAU OF ENGINEERING RESEARCH  
THE UNIVERSITY OF TEXAS AT AUSTIN**

**March 1991**

NOT INTENDED FOR CONSTRUCTION,  
BIDDING OR PERMIT PURPOSES

N. H. Burns, P.E. (Texas No. 20801)  
*Study Supervisor*

The contents of this report reflect the views of the authors, who are responsible for the facts and the accuracy of the data presented herein. The contents do not necessarily reflect the official views or policies of the Federal Highway Administration. This report does not constitute a standard, specification, or regulation.

Bringing in Covers

Monday!  
she noticed a mistake on  
the first 3 bring in On  
Monday

## PREFACE

This report is the second in a series which studies the transfer and development lengths of pretensioned prestressed strands. It studies the development length of pretensioned prestressing strands confined with external active transverse prestressing bars, which to a great extent reduces the required development length.

This report reviews the previous research work on the use of prestressing stirrups and shear strengthening of concrete members. It presents the different types of strengthening techniques used in reinforced concrete structures.

This work is part of Research Project 3-5-89-1210, entitled "*Influence of Debonding of Strands on Behavior of Composite Prestressed Beams*". It presents detailed investigation on the effect of external transverse post-tensioning bars on the behavior of pretensioned prestressed concrete composite flexural members. This research was conducted by the Phil M. Ferguson Structural Engineering Laboratory as part of the overall Research program of the Center for Transportation Research of The University of Texas at Austin. The work was sponsored jointly by the Texas State Department of Highways and Public Transportation and the Federal Highway Administration under an agreement with The University of Texas at Austin and the State Department of Highways and Public Transportation.

This portion of the overall study was directed by Dr. Ned H. Burns who holds the Barrow Centennial Professorship in Civil Engineering, in cooperation with Dr. James O. Jirsa who holds the Janet S. Cockrell Centennial Chair in Engineering, and Dr. Michael E. Kreger, Associate Professor of Civil Engineering. The design, fabrication and installation of the external post-tensioning system was done by Riyadh S. Aboutaha, Graduate Research Assistant. Testing was accomplished with the great assistance of Asit Baxi, Bruce Lutz, Bruce Russell, Ozgur Unay and Les Zumbunnen, Graduate Research Assistants.

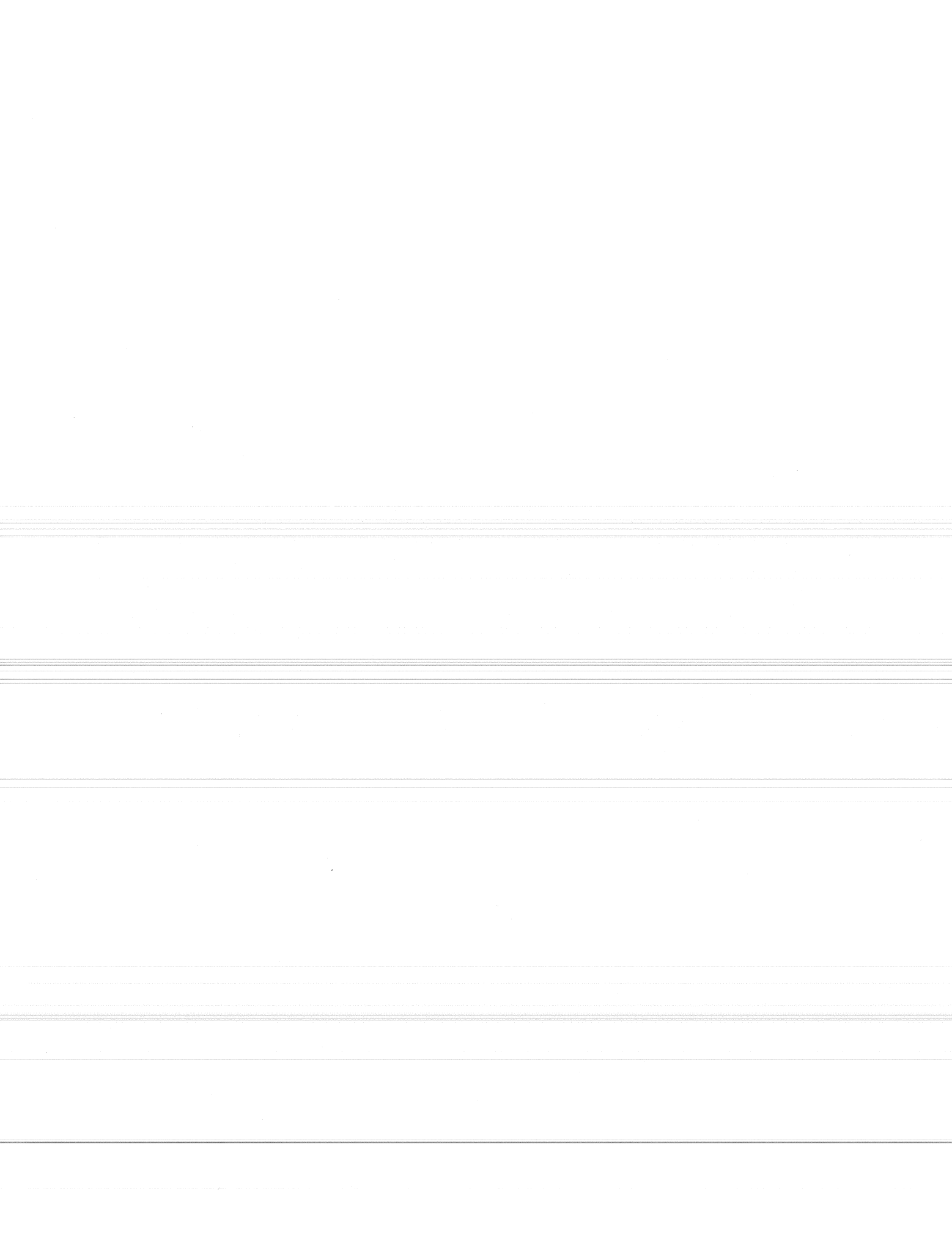

## SUMMARY

Recently, the repair and strengthening of existing structures has grown to occupy a significant share of the concrete construction market. Strengthening is required due to inadequacy which typically results from a poor design, a change in usage, or a change in design loads.

Prestressed composite beams require special attention in connection with their behavior in horizontal shear at the composite interface. Beams lacking adequate shear reinforcement experience brittle shear failure unless they have low flexural stiffness. Such beams can be strengthened, so that they can develop their flexural capacity and behavior in a more ductile manner at failure.

External post-tensioning systems are often a desirable strengthening solution when a major portion of a member must be strengthened or when the cracks which have formed must be closed. This research work studies the behavior of retrofitted prestressed composite beams that originally lacked shear reinforcement and have a smooth interface bonded with epoxy. Before retrofitting these beams experienced sudden horizontal shear failure. Ductile flexural failure occurred after being retrofitted by external prestressing bars. This research studied how the mode of failure of prestressed composite flexural members could be changed from a sudden shear failure to a ductile flexural failure by utilizing external prestressing bars. It studied the effect of these prestressing bars on the required development length of prestressing strands.

One unretrofitted and four retrofitted simply-supported beams were tested under two static stationary concentrated loads until failure. The provisions in the ACI Code 318-89 for the design of prestressed concrete composite beams were compared with the test results. Recommendations are made for the use of external prestressing systems as an effective strengthening system.





## IMPLEMENTATION

This report summarizes the results of test programs involving five pretensioned concrete composite flexural members lacking horizontal shear reinforcement. External post-tensioning bars have been used and proved their effectiveness in strengthening of prestressed concrete flexural members.

This study shows that external prestressing bars can be utilized as external transverse reinforcement to prevent sudden shear failure in beams lacking adequate shear reinforcement. Sudden shear failure, an unfavorable mode of failure, can be changed to a ductile flexural failure, which is a more favorable mode of failure, by using external post-tensioning bars.

Poorly designed girders and existing girders that are incapable of carrying new extra loads, can still be used utilizing external post-tensioning bars. It can be utilized in strengthening of pretensioned prestressed beams reinforced with strands lacking adequate development length. This research work proved that due to the active confinement of prestressing strands by the external prestressing bars, development length for the strands as short as 50% of the recommended values can be used and the beam can still develop its full flexural capacity.



# TABLE OF CONTENTS

		Page
CHAPTER ONE - Introduction .....		1
1.1	General .....	1
1.2	Limit States Design .....	2
1.3	Objective of Report .....	2
1.4	Scope of this Research. ....	3
1.5	Review of Literature .....	3
CHAPTER TWO - Modes of Failure of Prestressed Concrete Composite Flexural Members .....		7
2.1	Mechanics of Prestressed Concrete <sup>13, 14</sup> .....	7
2.2	Limit States Design <sup>13, 15</sup> .....	8
	2.2.1 Ultimate Limit States .....	8
	2.2.2 Serviceability Limit States .....	8
2.3	Modes of Failure of Prestressed Composite Beams .....	9
	2.3.1 Flexural Failure .....	9
	2.3.2 Shear Failure <sup>14</sup> .....	11
	2.3.2.1 Flexure-Shear Failure .....	11
	2.3.2.2 Web-Shear Failure .....	11
	2.3.2.3 Horizontal Shear Failure (Composite Sections) .....	11
	2.3.3 Bond Failure <sup>14, 22</sup> .....	12
CHAPTER THREE - Strengthening Techniques for Prestressed Concrete Flexural Members .....		15
3.1	General .....	15
3.2	Retrofitting Techniques .....	15
	3.2.1 Epoxy Injection <sup>12</sup> .....	15
	3.2.2 Bonding of External Reinforcement .....	16
	3.2.3 Conventional Reinforcement .....	17
	3.2.4 Post-Tensioning .....	17
CHAPTER FOUR - Test Program .....		23
4.1	Introduction .....	23
4.2	Test Specimen .....	23
	4.2.1 Details of Beams .....	23
	4.2.2 Strengthening System and Procedure .....	23
4.3	Materials .....	24
	4.3.1 Concrete .....	24
	4.3.2 Prestressing Strands .....	24
	4.3.3 Ordinary Reinforcement .....	24
	4.3.4 Prestressing Bars .....	25
	4.3.5 Epoxy Adhesive .....	25
4.4	Test Setup .....	26
	4.4.1 Description of Test Setup .....	26
	4.4.2 Loading Pattern and Increment .....	28

CHAPTER FIVE - Beam Test Results .....	33
5.1 General .....	33
5.2 Beam Tests .....	33
5.2.1 Beam B1 (Type Two - Cross Section, Fig. 4.1b) .....	33
5.2.2 Beam R1 (Type One - Cross Section, Fig. 4.1a) .....	35
5.2.3 Beam R2 (Type One - Cross Section, Fig. 4.1a) .....	39
5.2.4 Beam R3 (Type Two - Cross Section, Fig. 4.1b) .....	43
5.2.5 Beam R4 (Type One - Cross Section, Fig. 4.1a) .....	43
CHAPTER SIX - Comparison and Discussion of Test Results .....	49
6.1 General .....	49
6.2 Deflection .....	49
6.3 Cracking .....	50
6.3.1 Development of Cracks .....	50
6.3.2 Horizontal Cracks .....	52
6.4 Development Length <sup>23</sup> .....	54
6.4.1 ACI - Code Provisions .....	54
6.4.2 Effect of Transverse Prestressing on the Required Development Length .....	55
6.4.3 End Slip .....	56
6.4.4 Corrosion of Strands .....	56
6.5 Mode of Failure .....	56
6.6 Stresses in Strands .....	60
6.7 Ultimate Strength .....	61
6.7.1 Evaluation of Ultimate Shear Strength Under Biaxial Compression <sup>41</sup> .....	61
6.7.1.1 Diagonal Shear .....	61
6.7.1.2 Horizontal Shear .....	62
6.7.2 Evaluation of Ultimate Flexural Strength .....	62
CHAPTER SEVEN - Summary and Conclusions .....	65
7.1 Summary .....	65
7.2 Conclusions .....	65
APPENDIX A .....	67
APPENDIX B .....	69
APPENDIX C .....	71
APPENDIX D .....	73
APPENDIX E .....	77
BIBLIOGRAPHY .....	79

## LIST OF FIGURES

Figure		Page
1.1	Prestressed concrete composite sections . . . . .	2
1.2	Retrofitted prestressed composite section . . . . .	3
1.3	Test beam before and after retrofitting. . . . .	4
2.1	Flexural-shear failure . . . . .	12
2.2a	Web-shear failure . . . . .	12
2.2b	Typical analogies for shear failure mechanisms . . . . .	13
2.3a	Prestress transfer at end of pretensioned beams . . . . .	14
2.3b	Flexural bond overlapping with transfer length . . . . .	14
2.3c	Bond failure . . . . .	14
3.1	Epoxy resin injection technique . . . . .	16
3.2a	Shear strengthening using external bar bonding technique . . . . .	17
3.2b	Shear strengthening using external steel plate bonding technique . . . . .	18
3.3	Shear strengthening using conventional reinforcement and shotcrete . . . . .	19
3.4a	Strengthening using external prestressing strands or bars . . . . .	20
3.4b	Strengthening using external prestressing strands or bars . . . . .	20
3.4c	Shear strengthening using post-tensioning technique . . . . .	21
4.1(a)	Prestressed concrete composite beams, Type One (14' long beams) . . . . .	25
4.1(b)	Prestressed concrete composite beam, Type Two (16' long beams) . . . . .	26
4.1(c)	Test beams, level of stresses in the prestressing bars, in ksi . . . . .	27
4.2(a)	Retrofitted prestressed composite section . . . . .	28
4.2(b)	Locations of prestressing bars for Beams R1, R2 and R4 . . . . .	29
4.2(c)	Locations of prestressing bars for Beam R3 . . . . .	30
4.2(d)	Tensioning system . . . . .	31
4.3(a)	Test setup . . . . .	32
4.3(b)	Test specimen under testing frame . . . . .	32
5.1a	Loading pattern, Beam B1 . . . . .	34
5.1b	Load - Midspan deflection curve . . . . .	34
5.1c	Crack pattern, Beam B1 . . . . .	35
5.1d	Load vs. stresses in strands . . . . .	35
5.2a	Loading and cracking pattern, Beam R1 . . . . .	36
5.2b	Detail of horizontal shear insert . . . . .	37
5.2c	Load vs. stresses in strands (south end) . . . . .	38
5.2d	Load - deflection curve . . . . .	38
5.2e	Load vs. end slip (south end) . . . . .	38
5.2f	Load vs. end slip (north end) . . . . .	39
5.3a	Loading pattern . . . . .	39
5.3b	Load - deflection curve . . . . .	40
5.3c	Cracking patterns, Beam R2 . . . . .	40
5.3d	Load vs. end slip (south end) . . . . .	41
5.3e	Load vs. end slip (north end) . . . . .	41
5.3f	Load vs. stresses in strands (north end) . . . . .	42
5.3g	Load vs. stresses in prestressing bars (north end) . . . . .	42
5.4a	Load vs. end slip (south end) . . . . .	43
5.4b	Load vs. end slip (north end) . . . . .	44
5.4c	Load - Deflection curve . . . . .	44
5.4d	Loading and cracking pattern (Beam R3) . . . . .	45

5.5a	Differential movement of the cast-in-situ concrete deck against the prestressed beam due to horizontal shear failure .....	46
5.5b	Load - Deflection curve .....	47
5.5c	Loading and cracking patterns (Beam R4) .....	47
5.5d	Load vs. end slip (south end) .....	48
5.5e	Load vs. end slip (north end) .....	48
5.5f	Load vs. stresses in strands (north 20 ksi end) .....	48
6.1a	Load - Deflection curves, Beams B1 and R3 .....	49
6.1b	Beam R3 under testing frame .....	50
6.1c	Load - Deflection curves, Beams R2 and R4 .....	51
6.1d	Beam R2 under testing frame .....	51
6.2a	North end of Beam R4 at failure .....	52
6.2b	Beam R4 before removal of transverse prestressing bars .....	53
6.2c	Beam R4 after removal of transverse prestressing bars .....	54
6.3	Variation of steel stress with distance from free end of strand .....	55
6.4	Portion of the strands in the transfer zone after removal of concrete .....	58
6.5a	Mode of failure of Beam R1 (flexural failure - crushing of concrete) .....	58
6.5b	Mode of failure of Beam R2 (flexural failure - crushing of concrete) .....	59
6.5c	Mode of failure of Beam R3 (flexural failure - crushing of concrete) .....	59
6.5d	Mode of failure of Beam R4 (horizontal shear failure - differential movement) .....	60
6.6	MOHR's Circle for status of principal tensile stresses equal to zero .....	61
C.1	Ultimate shear force and concrete nominal shear strength (Beams R2 & R4) .....	72

## LIST OF TABLES

Table		Page
4.1	Equivalent Normal Stress on the Interface .....	24
4.2	Concrete Strength .....	24
6.1	End Slip of Prestressing Strands .....	57
6.2	Horizontal Shear Stress and Transverse Prestress at the Interface, Beams B1 and R3 .....	62
6.3	Horizontal Shear Stress and Transverse Prestress at the Interface, Beam R1 .....	63
6.4	Horizontal Shear Stress and Transverse Prestress at the Interface, Beams R2 and R4 .....	63
6.5	Comparison of the Test Cracking and Ultimate Moments with the ACI-Code Provisions .....	64
D.1	Horizontal Shear Stress at Failure (Beam R1) .....	73
D.2	Horizontal Shear Stress at Failure (Beam R2) .....	74
D.3	Horizontal Shear Stress at Failure (Beam R4) .....	74
D.4	Horizontal Shear Stress at Failure (Beam B1) .....	75
D.5	Horizontal Shear Stress at Failure (Beam R3) .....	75





# CHAPTER ONE

## Introduction

### 1.1 General

Recently, the repair and strengthening of existing structures has grown to occupy a significant share of the concrete construction market. Strengthening is required due to inadequacy which typically results from a poor design, a change in usage, or a change in design loads.

Changing the behavior of a structural system might be the principal reason behind strengthening a concrete structure. For example, strengthening techniques might be used to change the mode of failure of a composite beam that lacks adequate shear reinforcement from sudden shear failure to a more ductile flexural failure.

Post-tensioning techniques have been used for strengthening many existing bridges to improve their flexural capacity, and few have been modified to improve their shear capacity. These structures are often bridges which were designed for relatively light loading and have narrow roadways that were inadequate for new traffic.

Prestressed split beams are prestressed composite beams having their interface at the level of the centroidal axis of the cross section, with only the bottom portion of these split beams prestressed. Amirikian<sup>1</sup> proposed this type of beam to reduce the required prestressing force while maintaining their flexural capacity. As the prestressing is limited only to the bottom portion of the beam, this concept should result in a more economical design compared with the conventional design of prestressed concrete beams. Figure 1.1(a) shows a split beam of this type.

Prestressed composite beams require special attention in connection with their behavior in horizontal shear at the composite interface. The interface is subjected to higher horizontal shear stresses the closer it is to the centroidal axis of the cross section. Figure 1.1(b) shows a T-beam the neutral axis in the web where horizontal shear might be critical.

Unless these beams have low flexural stiffness, their probability of failure in horizontal shear is very high. For beams built without web reinforcement strengthening systems could be utilized as shown in this study to increase the shear capacity of such beams so that they can develop their flexural capacity and behavior in a more ductile manner at failure.

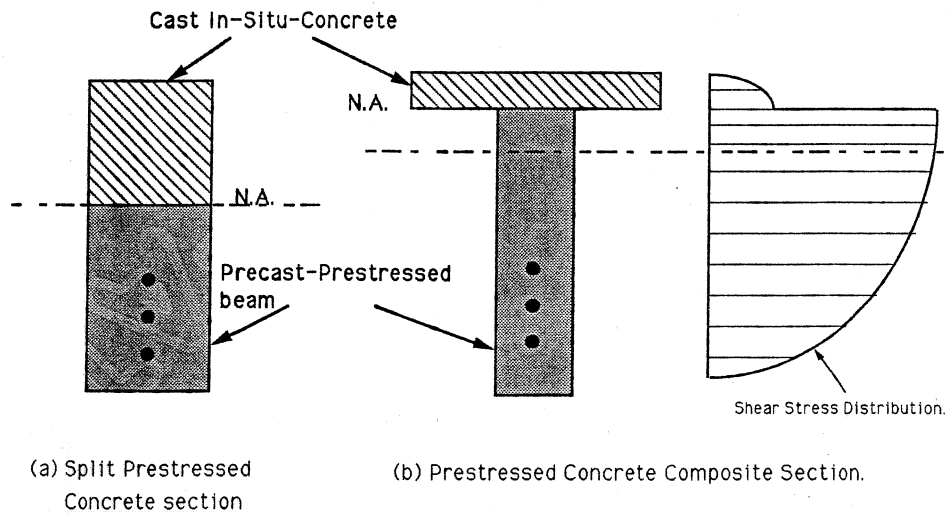

Figure 1.1 Prestressed concrete composite sections.

## 1.2 Limit States Design<sup>2</sup>

Limit state refers to a state at which a structure reaches its limit of usefulness. Limit states fall into two categories: Ultimate limit states corresponding to collapse of the structure, and serviceability limit states such as excessive vibration, deflection and cracking.

The process of ultimate limit state design determines all modes of failure. But one limit state is judged to be more important than the others, and this primary limit state could be the flexural strength, shear strength, or durability. Based on the incidence of shear failure observed in practice, it has been reported<sup>3</sup> that the shear is the most common mode of failure in reinforced concrete buildings. Diagonal tension failures are associated with beam-slab elements and have been responsible for many problems in reinforced concrete.

Composite beams that lack web reinforcement and horizontal shear connectors have the potential for horizontal shear failure as a primary limit state along with diagonal tension failure. In many cases this type of beam would not be able to develop flexural capacity without some type of strengthening system, such as added reinforcement.

## 1.3 Objective of Report

The objective of this report was to study the behavior of retrofitted prestressed composite beams lacking shear reinforcement and having a smooth interface bonded with epoxy. The precast-prestressed beams of the test specimens were a part of a study of transfer length of prestressing strands, sponsored by Texas State Department of Highways

and Public Transportation. After the study of transfer length was done it was decided to make use of these beams in a study of development length of prestressing strands, but since no web reinforcement was protruding at the interface, the prestressed composite beams experienced sudden horizontal shear failure before retrofitting. Ductile flexural failure occurred after being retrofitted by external prestressing bars. This research studied how the mode of failure of prestressed composite flexural member could be changed from sudden shear failure to ductile flexural failure by utilizing external prestressing bars, as well as the effect of those prestressing bars on the required development length of the prestressing strands in the bottom portion of the prestressed composite section. Figure 1.2 shows the retrofitted composite section tested in this study.

#### 1.4 Scope of this Research.

The scope of this thesis included an experimental test program of 5 beams and analytical study of simply supported beams subjected to different static loads. The level of prestressing force in the external prestressing bars (Fig. 1.2) was considered the principal variable in these tests. Actually this added reinforcement was the major factor in preventing horizontal shear failure and allowing flexural strength of the composite section to be developed.

One beam was tested before retrofitting and four retrofitted beams were tested under two concentrated loads as shown in Fig. 1.3. The provisions in ACI Code 318-89<sup>4</sup> for the design of prestressed concrete composite beams were compared with the test results. Recommendations are made for the use of external prestressing systems as an effective strengthening system.

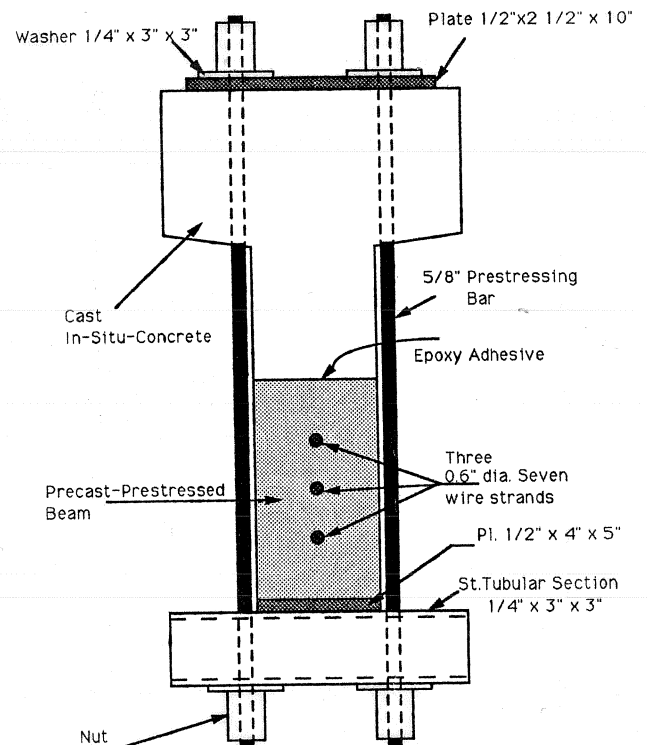

Figure 1.2 Retrofitted prestressed composite section.

#### 1.5 Review of Literature

Composite construction is used to economize over normal prestressed concrete design and yet retain the advantage of that type of construction. The basic economics comes from

two sources (1) the in-situ concrete need not be of the quality necessary for prestressing, and (2) the prestressed units may be used as permanent forms for the in-situ concrete. A composite section beam will work efficiently as one cross section if adequate transfer of horizontal shear exists. If there is a weakness at the interface, the member is considered only partially composite with stiffness between that of the composite and the two piece system.

In a study of composite action between precast girders and an in-situ cast deck slab at the Research and Development Laboratories of The Portland Cement Association<sup>5</sup>, push-off tests on specimens without stirrups showed that the horizontal shear transferred at the contact surface for rough and bonded surfaces is nearly twice that of the smooth bonded surface.

Evans and Parker<sup>6</sup> reported that bond between prestressed and in-situ concrete may be assisted by leaving stirrups protruding from the prestressed concrete. This is only necessary when the jointing surface is not sufficiently rough in itself, and in that case the bond may still fail between the stirrups.

Besides the shear stresses at the contact surface due to loading of composite beams, shrinkage of in-situ concrete, shrinkage of prestressed concrete and the creep in the prestressed portion, may affect the behavior of these beams. Evans and Parker reported that the differential shrinkage between the two elements may affect the cracking load by  $\pm 20$  percent.

Experimental research on the flexural properties of composite concrete beams without web reinforcement or shear connectors was carried out at the National Bureau of Standards<sup>7</sup>. The tests showed that the flexural behavior of these composite beams was similar to that of monolithic beams up to the cracking load but beyond the cracking load they exhibited lesser degree of stiffness. All beams tested in The NBS investigation failed by flexural compression and the average shear stress at maximum load at the interface was 312 psi. Good bond was developed between the cast in-situ concrete and prestressed concrete by roughening the top surface of the prestressed beam to such an extent that the largest size aggregate was exposed. It is important to note here that the maximum shear stress at the interface in these tests (312 psi), was lower than the 350 psi allowable shear stress at ultimate given by ACI 318-89 sub-clause 17.5.2.3.

In an experimental and analytical study on the dynamic behavior and resistance of prestressed concrete split beams at The University of Texas at Austin<sup>8</sup> carried out by Veeraiah and supervised by Dr. N.H. Burns, nine split beams were tested and showed that

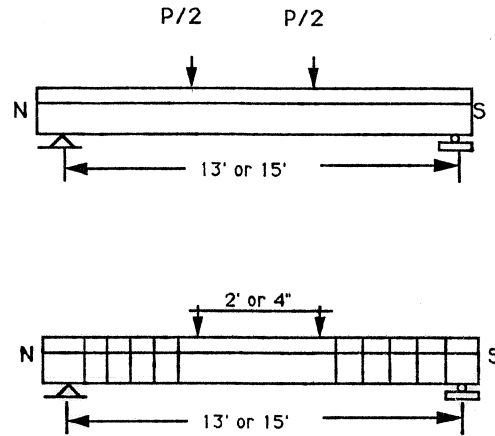

Figure 1.3 Test beam before and after retrofitting.

adequate shear reinforcement must be provided to avoid horizontal shear failure of prestressed split beams under dynamic loading, and that the dynamic horizontal shear capacity of a split beam is less than its static horizontal shear capacity.

Elstner and Hognestad<sup>9</sup> proposed using external prestressed steel straps for retrofitting rigid frames at AMC warehouse, Wilkins Air Force Depot, Ohio<sup>10</sup>, where the failure of some frames took place by a combination of diagonal tension due to dead load and axial tension due to shrinkage and temperature change. Although calculations indicated that the structural design of the warehouses was according to generally accepted American building codes with accepted materials, it was considered highly probable that the type of distress involved could have been avoided by sufficient web reinforcement.

An experimental investigation of a 1/3-scale frame model at the Research and Development Laboratories of the Portland Cement Association showed clearly that externally applied prestressed straps can be used effectively as web reinforcement<sup>9</sup>. Straps placed after diagonal cracking had developed prevented further opening of the cracks, and straps placed before the beams were loaded prevented diagonal cracking. Tests were made on other groups of strengthened beams, in which the strap reinforcement was designed by Elstner and Hognestad to be light enough to result in failure of the straps during beam testing. Diagonal cracks formed in these beams but they were prevented from opening by the straps, and did not cause failure, it was reported as well that the stress in all the straps remained at the prestress level until the haunches next to supports cracked at a load equaled to 55% of the ultimate load. Afterwards the stresses in the straps were increasing with the load until the beams developed their ultimate flexural capacities.

Bruce<sup>11</sup> carried out a study on the contribution of web reinforcement to the shear strength of prestressed concrete I-beams. Tests on prestressed concrete beams having unbonded stirrups showed that the inclined cracking load and failure load increased with increasing prestress, even though the increased prestress was provided by equal amounts of web reinforcement for all the beams. For the load condition just prior to failure, it was obvious that the stirrups having the lowest initial prestress showed the largest force increase.

In a recent laboratory investigation of the shear repair of reinforced concrete beams loaded in flexure at The University of Sydney, Australia, Collins and Roper<sup>12</sup> studied the structural rehabilitation of reinforced concrete beams in shear. Four methods of strengthening reinforced concrete members unreinforced in shear were selected: post-tensioning, bar bonding, stitching and resin injection. In the post-tensioning method five mm prestressing tendons were tensioned using a hydraulic jack in a vertical position parallel to the line of load. Each tendon was loaded to nearly 80 percent of its yield load. In this investigation, the post-tensioning repair technique proved to be the best method when a major portion of a member must be strengthened or when the cracks which have formed must be closed. Their tests showed as well that the mode of final failure was a ductile flexural failure, while it could have been sudden shear failure without the prestressing tendons.

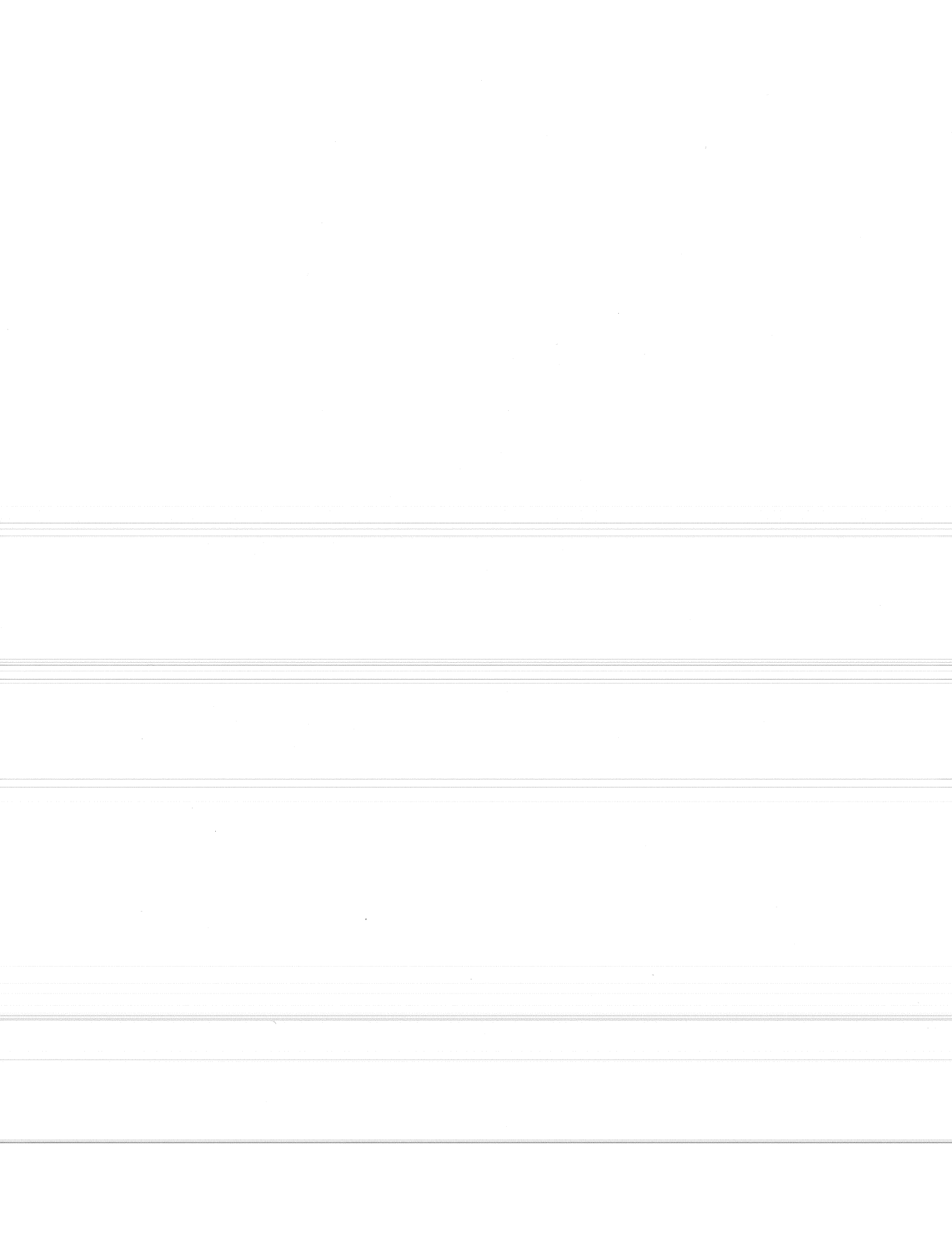

## CHAPTER TWO

### Modes of Failure of Prestressed Concrete Composite Flexural Members

#### 2.1 Mechanics of Prestressed Concrete<sup>13, 14</sup>

Concrete is strong in compression but weak in tension. As a result, cracks develop whenever external loads of any type give rise to tensile stresses in excess of the tensile strength of the concrete. A plain concrete beam fails very suddenly and completely when the first crack forms. In a reinforced concrete beam, steel bars are embedded in the concrete in such a way that the tension forces needed for moment equilibrium after the concrete cracks can be developed in the bars.

Prestressed concrete is usually made of high-strength concrete with high-strength steel which participates in an "active" way in the behavior of beams. This is achieved by tensioning the prestressing tendon and holding it against the concrete, thus putting the concrete, which is weak in tension and strong in compression, into compression. Consequently, cracking is delayed and the entire section of the concrete cross section is effective. Thus it is possible to use a smaller section in prestressed concrete to carry the same amount of external load.

In prestressed concrete, the term composite construction usually refers to construction in which a precast concrete member (either by pretensioning or by post-tensioning) acts in combination with concrete cast-in-place, poured at a later time. The behavior of prestressed concrete composite beams can be essentially reduced to that of noncomposite beams. The main differences to consider are:

1. The loading stage and their relation to whether the beam responds as a composite or noncomposite beam;
2. The transformed effective flange width and corresponding transformed section properties;
3. The horizontal shear at the interface between the precast beam and the cast-in-place concrete.

Before we study the modes of failure of prestressed concrete composite beams, let us review the advantages of these beams. Composite construction can result in appreciable savings in construction cost and reduction in construction time when precast concrete elements are used. Some of the advantages are:

1. Factory prefabrication of standardized sections;
2. Reuse of forms;



3. Long-line tensioning of strands;
4. Excellent quality control of prestressed concrete elements;
5. On site, formwork and scaffolding are largely eliminated.

One of the few limitations of composite construction is the size, overall dimensions and weight, of precast prestressed units that can be transported and erected. Of course, equipments for handling the precast-prestressed units must be available.

## 2.2 Limit State Design<sup>13, 15</sup>

The limit state concept involves identification of the various factors that affect the suitability of a structure to fulfill the purpose for which it is designed. Each of these factors is termed a limit state. The structure is deemed to have "failed" if it reaches any of the limit states. The limit states for prestressed concrete structures can be divided into two basic groups.

**2.2.1 Ultimate Limit States.** The ultimate limit states involve a structural collapse of part or all of the structure. Such collapse can occur in several ways, including fracture of an individual member, or instability of the structure as a whole. The major ultimate states are:

1. Loss of equilibrium of part or all of the structure when considered as a rigid body.
2. Progressive collapse. In some cases minor collapse might lead to progressive collapse due to overload. This can be prevented by proper detailing and considering alternate load paths.
3. Fatigue. Fracture of members due to repeated stress cycles may cause collapse of part or all of a structure. This could be important, especially in the case of prestressed concrete structures where the stress level in the prestressing steel is very high.
4. Instability, due to deformations of the structure, e.g. buckling.
5. Rupture of critical parts of the structure, leading to partial or complete collapse, this limit state includes the flexural failure and shear failure, which are discussed in detail in Section 2.3.

**2.2.2 Serviceability Limit States.** The serviceability limit states affect the functional use of the structure, but no collapse. The major serviceability limit states include:

1. Excessive deflection<sup>14</sup>. Deflection of prestressed flexural members under their own weight is small, owing to the cambering effect of prestress. Even under live load, deflection is smaller because of the effectiveness of the entire uncracked concrete section. But when the beam is loaded beyond its working load, and when the cracks have developed to an appreciable degree at high overloads, portions of the steel may be stressed beyond the elastic limit in the cracking region of the beam. In such cases there will be permanent loss of prestress upon the removal of load, and the prestress can be entirely lost depending on the degree of overload.
2. Cracking. Excessive cracking may not only be unsightly, but may lead to excessive ingress of water into the concrete, leading to corrosion of the steel. This is considered more serious in prestressed concrete than in reinforced concrete due to high level of stress in the prestressing steel with smaller steel are due to the use of high-strength material.
3. Durability. If the concrete is too permeable, then the risk of corrosion of the steel is increased. This is of particular importance in unbonded members.

### 2.3 Modes of Failure of Prestressed Composite Beams

Prestressed concrete beams may fail initially by excessive elongation of prestressing tendons, by crushing of concrete in the compression zone, by fracture of longitudinal prestressing tendons, by shear or diagonal tension, or by bond.

*2.3.1 Flexural Failure.* Under-reinforced beams fail initially by excessive elongation of prestressing tendons, while over-reinforced beams fail initially by crushing of concrete with the prestressing tendons still in the elastic range.

Billet and Appleton<sup>16</sup> carried out analytical and experimental studies on the behavior and ultimate flexural strength of post-tensioned, end-anchored, bonded, prestressed concrete beams. They reported that the final failure of both under-reinforced and over-reinforced prestressed beams appeared somewhat similar, and both reached the same maximum load when concrete in the compression zone crushed. However, appearance and behavior of these two types of beams were different in many respects at loads below the ultimate.

At loads approaching failure of an *under-reinforced* beam, the reinforcement is stressed into the inelastic range, and there is only a slight increase in load as the beam is deflected further. As a result of excessive elongation of the steel, cracks rise so that the compression zone is reduced until the internal compressive force can no longer be resisted by the concrete under the high strain gradient. Concrete generally crushes when extreme fiber strain reaches some limiting value ranging from about 0.003 to 0.0045. Since an under-

reinforced beam fails after steel enters the inelastic range, beam strength depends primarily on strength of the steel.

At loads approaching failure of an *over-reinforced* beam, cracks are lower than in an under-reinforced beam. As steel stress increases with further load, the resulting steel elongation allows cracks to progress higher. Near ultimate capacity of the beam, cracks cease to rise and in some cases the neutral axis drops slightly. Finally, a load is reached at which the capacity of the compression zone can no longer increase to balance increasing tensile force in the steel. At this stage flexural capacity is reached, the compression zone crushes when concrete reaches its limiting fiber strain. Since concrete crushes where stress in the steel is below yield stress, strength of an over-reinforced beam does not mainly depend on tensile or yield strength of prestressing tendons, but primarily on the amount of prestressing tendons and strength of concrete.

Zwoyer and Siess<sup>17</sup>, carried out tests on 34 simply-supported prestressed concrete beams without web reinforcement, in a study of the ultimate strength in shear of simply-supported prestressed concrete beams without web reinforcement. Their tests showed that before cracking of the concrete, all of the beams showed essentially "elastic" behavior. Deformations were linearly proportional to load, and the load could be released and reapplied without changing the behavior of the beams. Four of the beams failed initially in flexure. As the load was increased, cracks formed and the deformation of the beam began to increase more rapidly than the load. These cracks were vertical in the region of pure flexure between the loads but were inclined in the typical manner in the regions subjected to shear as well as flexure. Final failure occurred in all cases by crushing of the concrete in the compression zone of the beam. The four beams that failed in flexure, crushing of concrete occurred in the central portion of the beam over fully-developed flexure cracks and was preceded by yielding of the reinforcement.

The behavior of a prestressed concrete beam at the load causing failure depends basically on whether the section is under-reinforced or over-reinforced, but may be modified by the degree of bond between the steel and the concrete. In an under-reinforced member with *bonded tendons* the steel is the weaker part and failure is primarily due to the steel reaching its ultimate resistance. In an over-reinforced member the concrete is the weaker part, and failure will occur when the resistance of the concrete in the compressive zone is reached.

Since the steel in an *unbonded member* is free to elongate over its entire length it will rarely reach its ultimate resistance before the concrete fails in compression, and there is a tendency for unbonded beams to develop large cracks before rupture. These large cracks tend to concentrate strains at some localized sections in the concrete.

The considerations governing the conditions at ultimate load for *prestressed composite concrete members* are the same as those for ordinary prestressed concrete members. Particular care must be taken to ensure that adequate resistance to the ultimate shearing

forces is provided, and that the different strengths of the concrete in the slab and beam regions of the compression zone are taken into account.

**2.3.2 Shear Failure<sup>14</sup>.** Prestressed concrete beams possess greater reliability in shear resistance than reinforced concrete, because prestressing will usually prevent the occurrence of shrinkage cracks which reduce the shear resistance of reinforced concrete beams. Shear resistance at the ultimate limit state is very much dependent on whether or not the section in the region of greatest shear force has cracked. The presence of a prestressing force has an important influence in the development of cracking.

An extensive number of investigations<sup>18, 19, 20</sup>, have shown or confirmed that two types of shear related cracks can develop in prestressed concrete beams: flexure-shear cracks and web-shear cracks. The manner in which these cracks develop and grow strongly depends on the relative magnitude of shearing and flexural stresses.

**2.3.2.1 FLEXURE-SHEAR FAILURE.** Flexure-shear cracking is due to a combined effect of flexure and shear. The corresponding cracks started as flexural cracks. Then, due to the increased effect of diagonal tension at the tip of the crack, they deviate and propagate at an inclined direction corresponding essentially to the inclination of the diagonal tension plane. Typical flexure-shear cracks are shown in Fig. 2.1(a).

Flexural-shear cracking can lead to several types of failures, schematically illustrated in Fig. 2.1(b) and (c). Very slender beams generally fail in flexure either by their tensile reinforcement or by the concrete compressive zone. However, in beams with smaller shear span-to-depth ratio, failure may occur by flexure-shear cracking before the flexural capacity is developed. In moderately slender beams one of the cracks may continue to propagate until it becomes unstable, reaching throughout the depth of the beam and leading to diagonal tension failure.

**2.3.2.2 WEB-SHEAR FAILURE.** Web-shear cracking occurs when the magnitude of principal tension is relatively high in comparison to flexural stresses. It is characteristic of beams with narrow webs, such as I beams, where cracking due to diagonal tension develops before flexural cracking. The presence of these principal tension cracks tends to reduce the compressive depth of concrete, and the beam fails at a load lower than its capacity under pure flexure, Fig. 2.2(a).

In an attempt to better understand shear failure mechanisms, several models have been proposed and include limit analysis mechanisms or analogies with arches, trusses, or frames. The arch and truss analogies are illustrated in Fig. 2.2(b). The truss analogy is being given serious attention in current discussions of ultimate shear strength of reinforced and prestressed concrete members.

**2.3.2.3 HORIZONTAL SHEAR FAILURE (COMPOSITE SECTIONS).** The composite behavior of the precast beam and in-situ slab is only effective if the horizontal shear stresses

at the interface between the two concrete regions can be resisted. These shear stresses at the interface are a result of:

1. The differential shrinkage between the two, due to the difference between the age and quality of the two concretes;
2. The creep of the prestressed precast concrete;
3. The shearing forces due to the added load.

For wide shallow members, no mechanical key is usually required between the two types of concrete, and reliance is made on the friction developed between the contact surfaces. For deeper sections, mechanical shear connectors in the form of steel projecting from the precast beam into the cast-in-place slab are used to provide the necessary horizontal shear connection to develop composite flexural action. Horizontal shear failure is sudden, and is accompanied by differential movement between the precast and cast-in-situ concretes.

It is preferable to avoid shear failure as it is substantially more brittle than flexural failure. To supplement the shear resistance of concrete members and to ensure flexural failure prior to shear failure, shear reinforcement in the form of stirrups extended as composite connectors is generally provided.

**2.3.3 Bond Failure<sup>14, 22</sup>** Bond in pretensioned prestressed beams is of two types: *transfer bond* which exists near beam ends after the load in the tensioned strand has been transferred to the concrete member, and *flexural bond* which exists after the concrete beam has been loaded to cracking. Three factors which contribute to bond performance are:

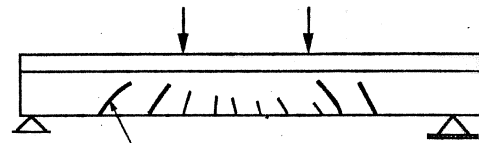

(a) Flexural - Shear Cracks

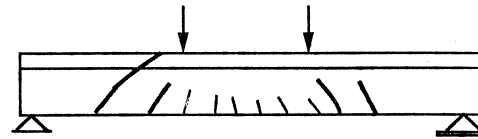

(b) Diagonal Tension Failure

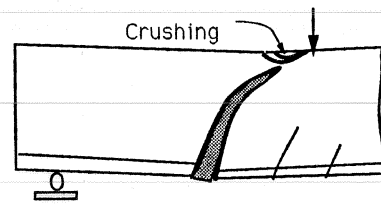

(c) Shear Compression Failure.

Figure 2.1 Flexural-shear failure.

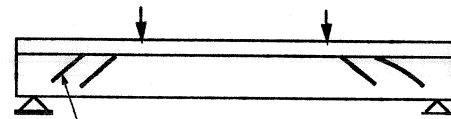

(a.1) Web - Shear Crack

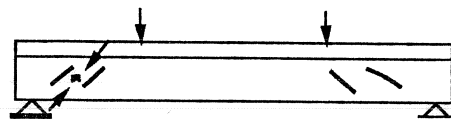

(a.2) Web - Crushing Failure

Figure 2.2a Web-shear failure

1. Adhesion between concrete and steel;
2. Friction between concrete and steel;
3. Mechanical resistance between concrete and steel.

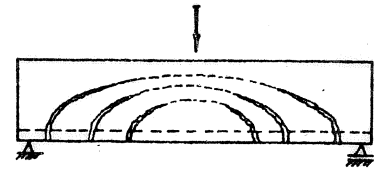

(b.1) Arch Analogy

Friction is considered to be the principal stress transfer mechanism for prestensioning steel to concrete. As the tension in the strand is released, the strand diameter tends to increase, thus producing high radial pressure against the concrete, Fig. 2.3(a). Repeated loading, outside of the transfer zone has no significant effect on the transfer length. However, if applied within the transfer zone, repeated loading could cause early bond failure if a crack developed within or near the transfer length<sup>23</sup>. The use of reinforcement to resist the bursting stress near the end of prestressing steel reduce slightly the transfer length, although the effect is not significant.

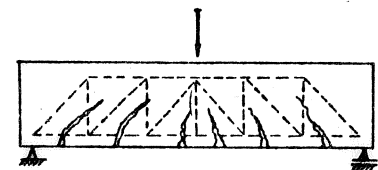

(b.2) Truss Analogy

Figure 2.2b Typical analogies for shear failure mechanisms.

When the concrete cracks, the bond stress in the immediate vicinity of the cracks reaches some limiting stress, slip occurs over a small portion of the strand length adjacent to the cracks, and the bond stress near the cracks is then reduced to a low value<sup>14</sup>. With continued increase in load, the high bond stress progresses as a wave from the original cracks toward the beam ends. The bond stress remaining behind the wave is always lower than the maximum value at the peak of the bond stress wave, Fig. 2.3(b). If the peak of the high bond stress wave reaches the prestress transfer zone, the increase in steel stress results in bond slip due to decrease in the strand diameter which reduces the frictional bond resistance, and precipitates general bond slip, as shown in Fig. 2.3(c).

Development length, which is the sum of transfer length and flexural bond length, affects the bending and shear strengths of all pretensioned members, particularly for shallow, short beams and cantilevers. In recent years there have been reports of bond failures of such members. According to Hanson and Kaar<sup>22</sup>, if the ultimate strength of the strand is to be developed by beam flexure before general bond slip occurs, the minimum required embedment lengths are approximately 70, 106, and 134 in., for 1/4, 3/8 and 1/2-in. diameter strands, respectively. A close examination of Hanson and Kaar's test data by Zia and Mostafa reveals that the actual embedment lengths for the strands which developed the ultimate strength before a general bond slip were considerably shorter than indicated above. A bond failure is highly probable if the development length is shorter than required to develop the yielding strength of the prestressing strand at the ultimate moment section.

Testing in the current research effort at the University of Texas at Austin with which this study is associated, is directly concerned with development length. The present study reported herein for five test beams is a special part of that study involving retrofitting to strengthen beams as discussed in the following chapter (Chapter 3).

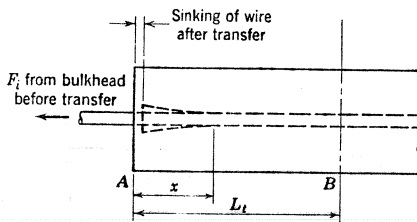

Figure 2.3a Prestress transfer at end of pretensioned beams.

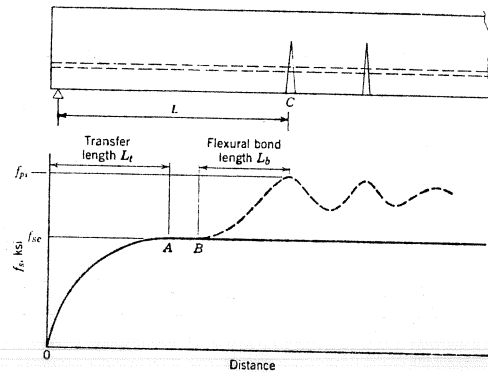

Figure 2.3b Flexural bond overlapping with transfer length, Ref. 14.

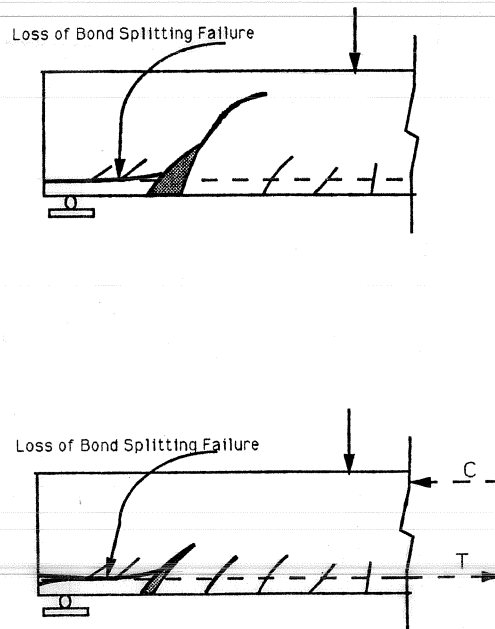

Figure 2.3c Bond failure.

## CHAPTER THREE

### Strengthening Techniques for Prestressed Concrete Flexural Members

#### 3.1 General

The proper strengthening technique depends greatly on the type and level of damage or weakness of a member. Cracks in concrete may develop due to many causes. They may affect appearance only, or they may indicate significant structural distress or a lack of durability. Their significance depends on their type and on the type of the structure.

Based on the careful evaluation of the extent and cause of damage/weakness<sup>24</sup>, procedures can be selected to accomplish one or more of the following objectives:

1. Restore or increase strength;
2. Restore or increase stiffness;
3. Improve functional performance;
4. Provide water tightness;
5. Prevent access of corrosive materials to reinforcement;
6. Improve durability.

#### 3.2 Retrofitting Techniques

Based on the nature of the damage/weakness, one or more retrofitting methods may be selected. For example, tensile strength can be restored across a crack by injecting it with epoxy. However, it may be necessary to provide additional strength by adding reinforcement or using post-tensioning. Epoxy injection alone can be used to restore flexural stiffness if further cracking is not anticipated.

Following the evaluation of the damaged/weak member, a suitable repair procedure can be selected. Successful strengthening procedures take into account the cause of the damage/weakness of that member. Four methods of strengthening prestressed concrete flexural members are described in Sections 3.2.1 through 3.2.4.

*3.2.1 Epoxy Injection*<sup>12</sup>. This repair method involves the process by which epoxy resins are injected in a controllable manner to fill or treat a crack or void, thereby restoring the structure to its original design capability and/or preventing further downgrading of the structure.

Resin properties are paramount to the successful application of this technique. Such properties as viscosity, curing, dimensional stability, elastic modulus, and adherence to a wet or damp highly alkaline interface require careful consideration. Two-component, non-solvented epoxy resins are almost exclusively used for injection in practice. Ideally, the resin



material should possess a low viscosity, depending on ambient temperature. This low viscosity allows adequate penetration into the finest of cracks. Cracks should be sealed on the surface and around the injection ports before injection of epoxy resin to prevent flow of epoxy resin during injection as shown in Fig. 3.1.

Shear repair of reinforced concrete members by resin injection has been the focus of laboratory studies by Chung and Liu<sup>25</sup>, Hewlett and Morgan<sup>26</sup>, and Brondum-Nielsen<sup>27</sup>. Chung and Lui's work focused on eight concrete pushoff specimens. The limited test results indicated a complete restoration of shear resistance within repaired joints<sup>25</sup>. Hewlett and Morgan<sup>26</sup> studied shear repair of reinforced concrete beams subjected to unidirectional static loading. Test results indicated structural reinstatement of beams with diagonal tension cracks. Repaired beams were found to be stiffer and stronger than the original beams. Brondum-Nielsen<sup>27</sup> recorded strength increases with laboratory-scale models of field-size reinforced concrete beams with circular web openings. Specimens were few and results widely scattered.

Resin injection as a means of restoring shear cracks has been used successfully on numerous reinforced concrete structures. Restoration of highway bridges subject to shear cracking has been documented by Stratton, Alexander, and Nolting<sup>28</sup>. Success of the resin injection technique for shear repair has been observed for beams as reported, by Brondum-Nielsen.

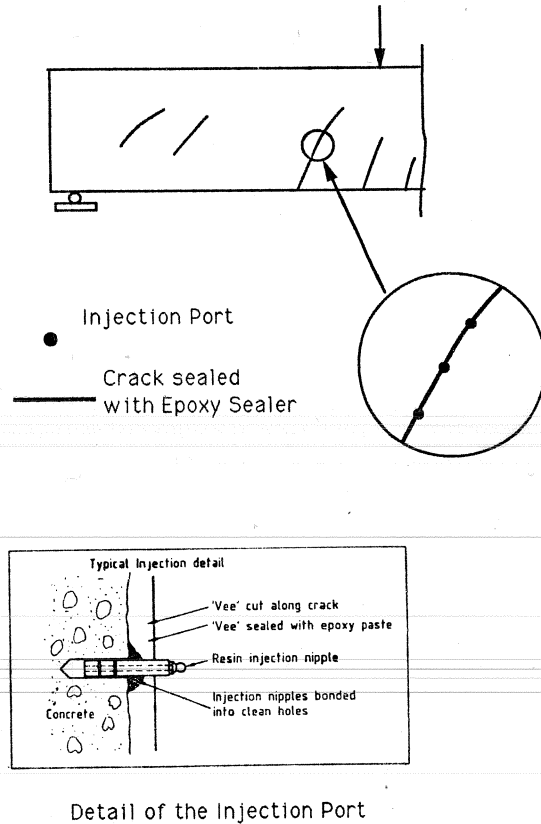

Figure 3.1 Epoxy resin injection technique.

**3.2.2 Bonding of External Reinforcement.** Epoxy adhesives have the distinct advantage of being able to bond dissimilar materials. Additional reinforcing bars or steel plates may be bonded externally to the concrete in areas of high shear stress. The main objective in strengthening structures by external reinforcement is to achieve a high shear strength between the steel - resin adhesive interface, and concrete-resin interface. Previous studies have shown that when a thin layer of epoxy resin is used to bond concrete to steel, failure almost always occurs in the concrete adjacent to the concrete-resin interface and, thus, significant increases in live load-bearing capacities of structures can be achieved<sup>29, 30, 31</sup>. Extensive field applications of this method have been documented<sup>32, 33, 34</sup> with external reinforcement bonded as shown in Fig. 3.2a and b.

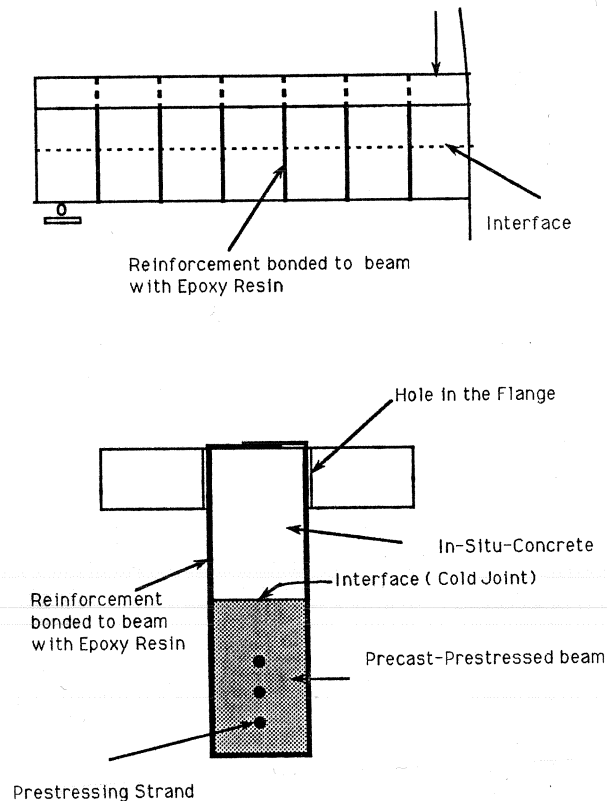

Figure 3.2a Shear strengthening using external bar bonding technique.

**3.2.3 Conventional Reinforcement.** Cracked reinforced concrete bridge girders have been successfully repaired using epoxy injection and reinforcing bar insertion<sup>28</sup>. This technique consists of sealing the crack, drilling the holes at 45 degrees to the deck surface and crossing the crack plane at approximately 90 degrees, filling the hole and crack plane with epoxy pumped under low pressure (50 to 80 psi), and placing a reinforcing bar into the drilled holes, as shown in Figure 3.3a. Epoxy bonds the bar to the walls of the hole, fills the crack plane, bonds the cracked concrete surfaces back together in one monolithic form, and thus reinforces the section.

Figure 3.3b shows a similar technique applied to strengthening the web of cracked beams<sup>35</sup>, using additional web reinforcement and new shotcrete encasement. The new and existing concrete section must be adequately bonded so that no slippage at the interface can occur as the new reinforcement picks up load.

**3.2.4 Post-Tensioning.** Post-tensioning is often a desirable solution when a major portion of a member must be strengthened or when the cracks which have formed must be closed. This technique uses prestressing strands or bars to apply a compressive force across

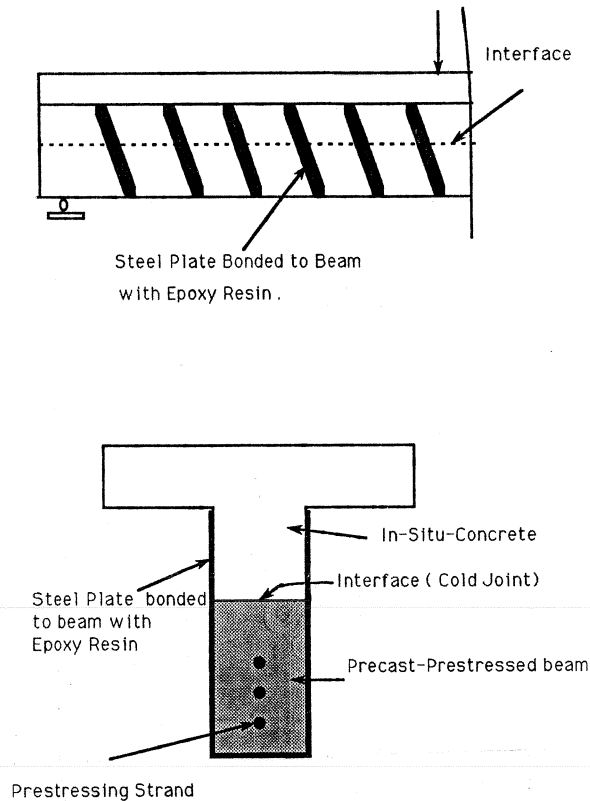

Figure 3.2b Shear strengthening using external steel plate bonding technique.

the crack plane, or to prevent the further development of a crack. Adequate anchorage must be provided for the prestressing steel, and care is needed so that the problem will not merely migrate to another part of the structure. Figure 3.4a shows post-tensioned bars or strands along the face of the concrete, or the tendons can be passed through an anchor bolted to the member in connecting framing, as shown in Fig. 3.4b. For indeterminate structures, the effects of secondary moments and induced reactions due to post-tensioning should be considered. The method of providing additional strength by external prestressing tendons has been adopted for many concrete, as well as steel, structures<sup>33, 36, 37</sup>.

In a laboratory investigation of shear repair of reinforced beams loaded in flexure<sup>12</sup>, concrete beams having shear cracks were strengthened by external post-tensioning wires as shown in Fig. 3.4c. The test results showed that post-tensioning in shear of model beams produced considerable strength increases, and the final mechanism was characterized by a ductile flexural failure.

Prestressed concrete composite members that lack adequate horizontal shear connectors or web shear reinforcement could be retrofitted using external prestressing tendons. By inducing a compression force on the interface between the precast beam and

the cast in-situ concrete, the horizontal shear failure can be prevented. Application of the external tendons of the type shown in Fig. 3.4c was used in this study to provide both shear strength and horizontal shear strength at a composite interface as described in the following chapter.

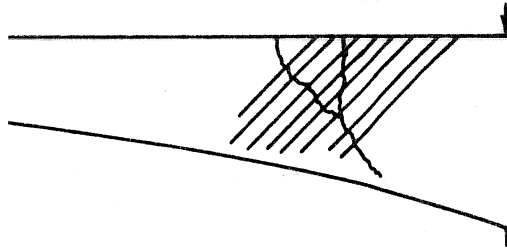

(a) Shear Strengthening using Conventional Reinforcement (Ref. 28)

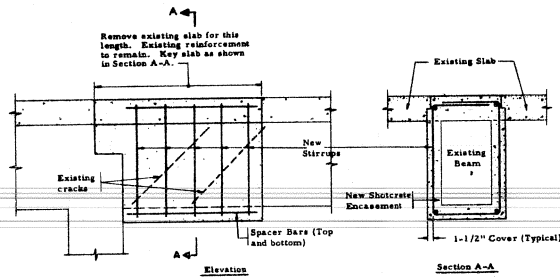

(b) Shear Strengthening using Conventional Reinforcement and Shotcrete

Figure 3.3 Shear strengthening using conventional reinforcement and shotcrete.

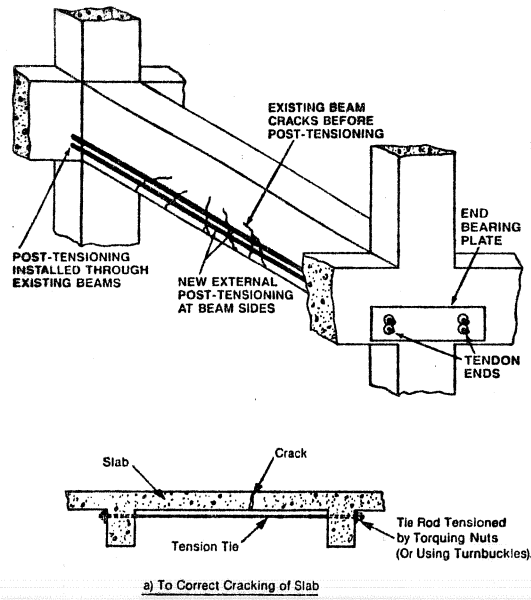

Figure 3.4a Strengthening using external prestressing strands or bars.

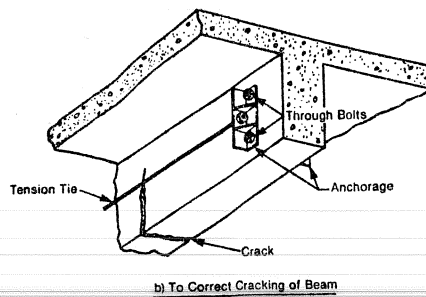

Figure 3.4b Strengthening using external prestressing strands or bars.

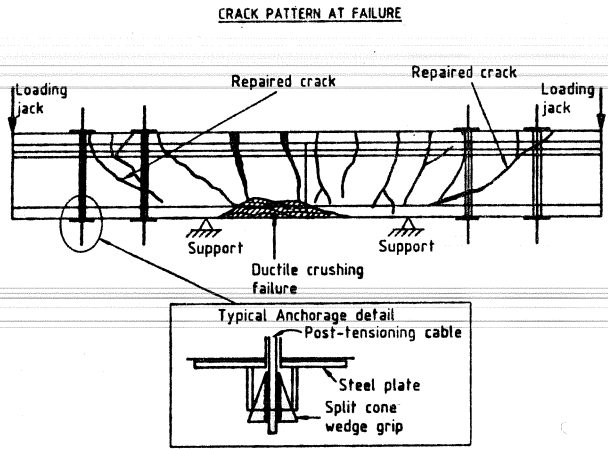
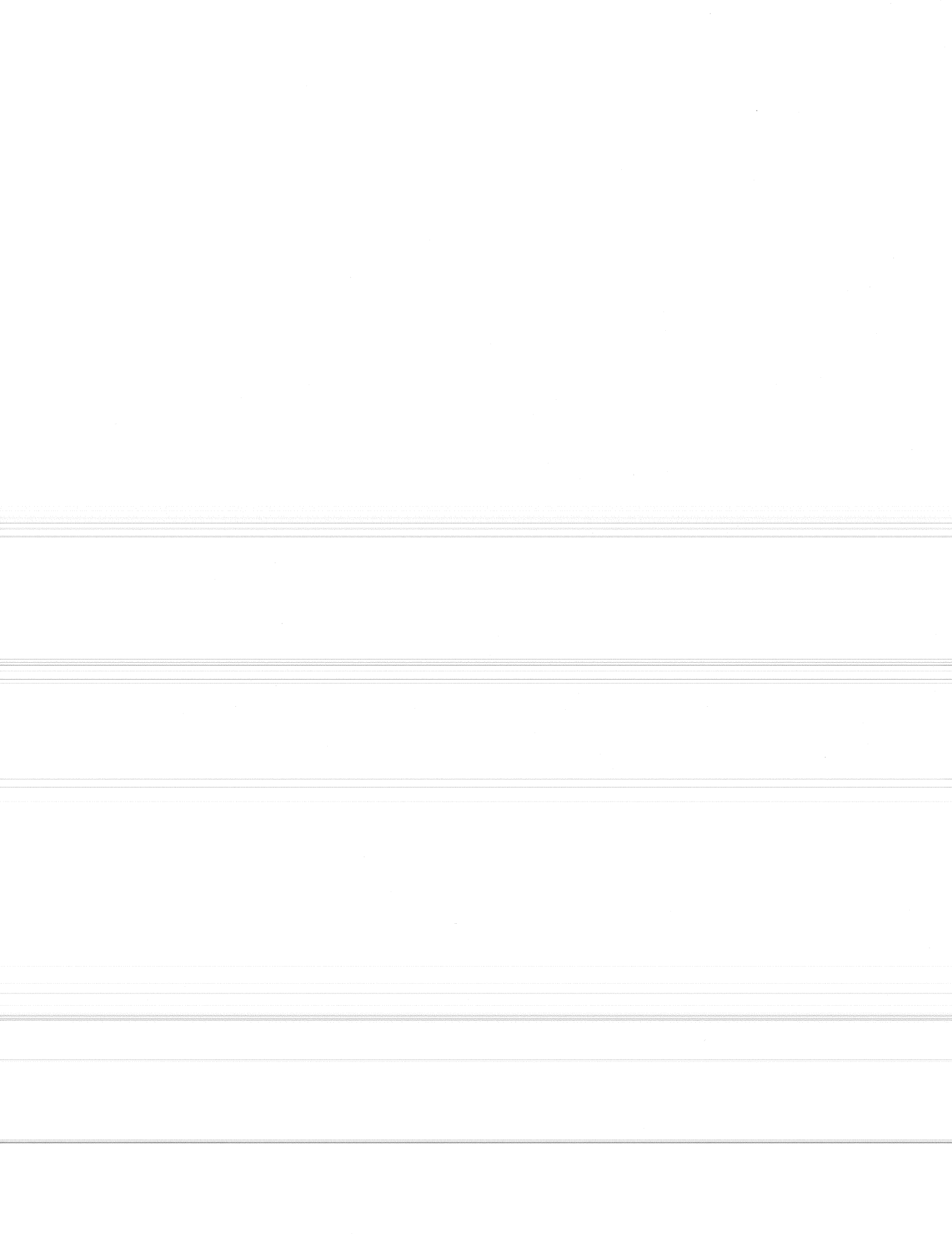

Figure 3.4c Shear strengthening using post-tensioning technique.



## CHAPTER FOUR

### Test Program

#### 4.1 Introduction

The purpose of the tests reported in this thesis was to improve the shear capacity of prestressed concrete composite beams that lacked shear reinforcement. The objective was to change the mode of failure from sudden shear failure to ductile flexural failure by utilizing external prestressing bars.

This chapter discusses the set up of the test hardware, the types of instrumentation used for measurement of end slip, and the description of the materials used.

#### 4.2 Test Specimen

*4.2.1 Details of Beams.* Five T-shaped prestressed concrete composite beams were tested in flexure. The precast-prestressed beams were used for a study of transfer length of pretensioning strand as part of a project sponsored by Texas State Department of Highways and Public Transportation. Beams were of two types and lengths. Figure 4.1 (a) and (b) shows the sections of these beams. The shaded areas show the precast-prestressed beams which were reinforced with three 0.6 in. diameter straight strands. Appendix A shows the properties of areas of these sections.

All beams were simply-supported, and subjected to two stationary concentrated loads as shown in Figure 4.1(c). As shown in the previous figures, no web shear reinforcement nor horizontal shear connectors were provided across the interface between the precast-prestressed beams and the cast-in-situ concrete. Epoxy adhesive was applied on the top of the precast-prestressed beam before placing the in-situ concrete portion of the cross sections shown. The prestressing strands were tensioned to 70% of their actual ultimate strength, (in a range 195-205 ksi), with an average of 200 ksi initial prestress.

Figure 4.1(c) shows the load patterns and the level of prestress in the external post-tensioning bars for the retrofitted beams. Table 4.1 shows the equivalent normal stress on the composite interface due to the external prestressing bars.

*4.2.2 Strengthening System and Procedure.* Post-tensioning was applied to each shear span using 5/8-inch diameter prestressing bars. The post-tensioning was applied vertically, i.e., in a line normal to the beam and parallel to the line of load application. Pairs of holes were drilled vertically in the flange as shown in Fig. 4.2(a). Specified locations are shown in Figure 4.2(b) and (c) for the external post-tensioned pairs of bars. The levels of stress in the bars are given later in section 5 for each of the beams.



A 60-kip hydraulic jack applied tension to the prestressing bars. The prestressing bars were anchored to the beam flange by a steel plate and nuts for use with threaded bars. On the beams tension face (the bottom of the web), the prestressing bars were anchored by a set of steel plates to reduce bearing stresses on the concrete. A structural tubular transferred load from the bolts to the plate. Figure 4.2(d) shows the prestressing bars during tensioning.

### 4.3 Materials

**4.3.1 Concrete.** The normal weight concrete was ready-mixed concrete with Type-1 Portland cement. The maximum aggregate size was 3/8-inch in order to accommodate the small dimension of the specimens, although 3/4-inch aggregate would be allowed by the Code. Concrete cylinder tests showed a compressive strength between 6000 and 7500 psi at 28 days as shown in Table 4.2. No superplasticizers or other water reducing admixtures were used.

**4.3.2 Prestressing Strands.** The prestressing strand used for this series of tests was uncoated seven-wire strand. Low relaxation strand with an ultimate strength of 270 ksi was used because this material is becoming the industry standard. The strand was not treated in any special manner such as wiping or cleaning with acid before casting, and the surface condition was that of brilliant mill condition.

**4.3.3 Ordinary Reinforcement.** Deformed #3 bars grade 60 were used as flexural reinforcement, in the cast-in-situ concrete portion, to prevent flexural cracks in that portion during handling.

Beam	Stress in the Prestressing Bars in (ksi)	Normal Stresses at the Interface in (psi)
B1	0.0	0.0
R1	80.0	829.6
R2	60.0	509.0
R3	50.0 (N)	407.3
	40.0 (S)	339.4
R4	40.0 (S)	339.4
	20.0 (N)	169.7

	Type-1 Beams	Type-2 Beams
Prestressed Beam	6250 psi at 28 days	7525 psi at 28 days
Cast-in-Place Concrete	7970 psi at 5 months	8125 psi at 5 months

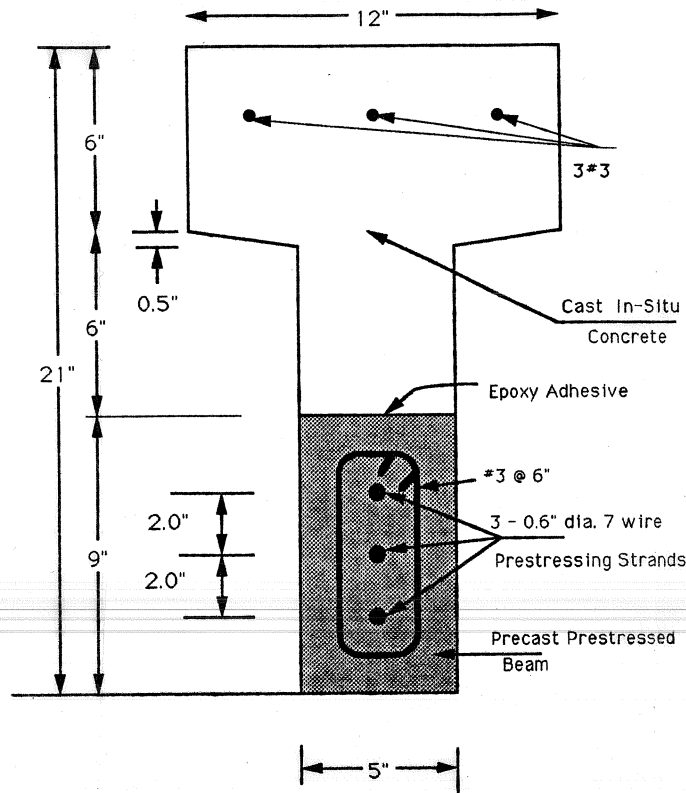

Figure 4.1(a) Prestressed concrete composite beams, Type One (14' long beams).

Deformed #3 grade 60 hoops were used in the precast-prestressed beams as shown in Fig. 4.2(a), but they were not extended into the cast-in-situ concrete.

**4.3.4 Prestressing Bars.** High-strength Dywidag 5/8-inch diameter prestressing bars were used for strengthening the beams. The ultimate strength of the post-tensioned bars was about 145,000 psi. The deformations on the bars served as threads to fit the anchorage hardware, which consisted of a nut with outside diameter about twice that of the bar and length about twice its diameter.

**4.3.5 Epoxy Adhesive.** A multi-purpose structural epoxy adhesive was used at the interface between the precast-prestressed beam and the cast-in-situ concrete. It was made of two components, which were mixed just prior to application. Its mechanical properties are: (furnished by the epoxy supplier)

Bond strength, (ASTM C-882) at 14 days	= 1900 psi
Shear strength, (ASTM D-732) at 14 days	= 5900 psi
Tensile properties (ASTM D-638)	
Tensile strength at 14 days	= 4800 psi
Modulus of elasticity	= $3.2 \times 10^5$ psi

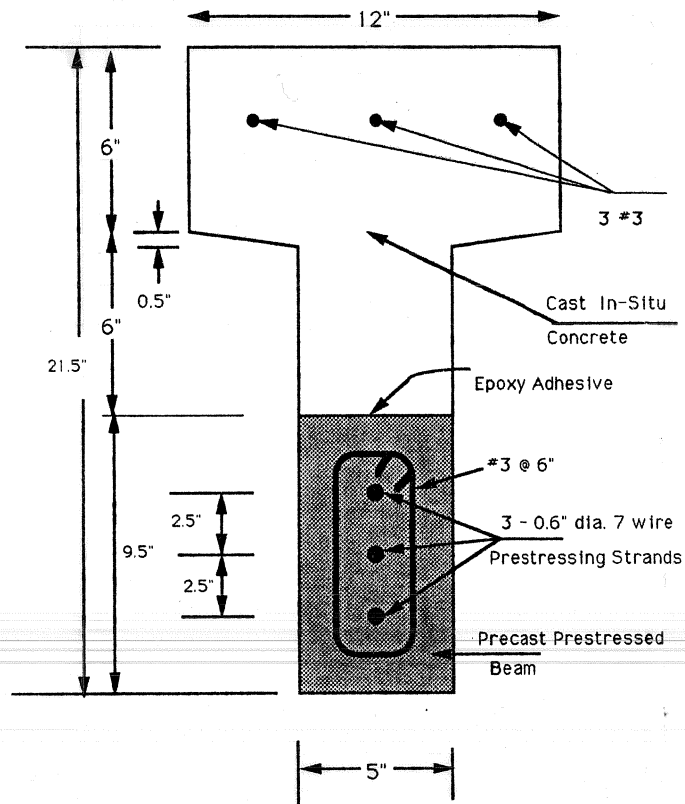
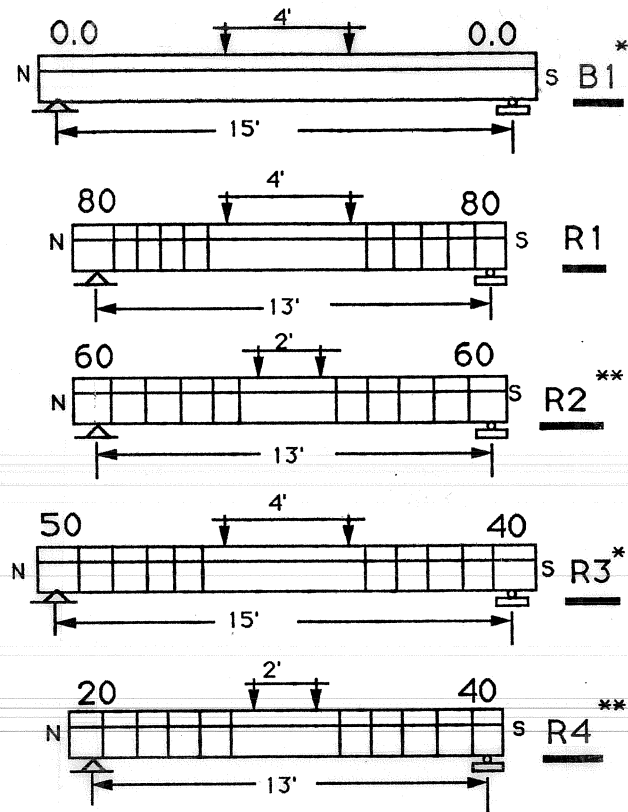

Figure 4.1(b) Prestressed concrete composite beam, Type Two (16' long beams).

Compressive properties, (ASTM D-695)	
Compressive strength at 28 days	= approx. 8500 psi
Modulus of elasticity	= $4.4 \times 10^5$ psi
Flexural properties (ASTM D-790) at 14 days	
Flexural strength (modulus of rupture)	= 7400 psi
Tangent modulus of elasticity in bending	= $4.7 \times 10^5$ psi

#### 4.4 Test Setup

*4.4.1 Description of Test Setup.* Beams were tested in flexure under two concentrated stationary loads applied to the beam using one hydraulic ram (capacity 200 kips and stroke 10 inches) and a spreader beam. The load was applied against a structural steel frame connected to the floor as shown in Figure 4.3(a). The beam was supported by two structural steel W-shaped beams, to allow testing beams of different lengths and to distribute the reaction load to the test floor. A ball-bearing unit was used under the ram to ensure the transfer of pure axial load to the spreader beam. A pin support was used under the test specimen. Figure 4.3(b) shows a test specimen under load in the testing frame.



\* 16' long companion beams, \*\* 14' long companion beams.  
 same span and loading                      same span and loading

Figure 4.1(c) Test beams, level of stresses in the prestressing bars, in ksi.

- (a) Load: The applied load was measured with a load cell provided between the testing frame and the hydraulic ram. Two load cells were also provided under the reactions at the ends of test specimen.
- (b) Deflection: Deflections at midspan were measured using a potentiometer of 6-inch stroke with accuracy of 1/1000 of an inch.
- (c) End slip of strands: End slips of all the strands at both ends of the test specimen were measured using potentiometers of 2-inch stroke with accuracy of 1/1000 of an inch. Potentiometers were clamped to strands and reacted against the concrete surface at the beam ends.
- (d) Strain of strand: Strain gages were placed on an individual wire of the seven-wire strand to measure the strains in the strand at all levels of loading. All gages were

bonded with M-bond 200 adhesive in a direction parallel to the wire. Then they were protected by mastic sealant and covered with water-proofing liquid sealant.

Strain gages were placed on the external prestressing bars added to beam R2, to measure the level of strains in these bars at different levels of loading.

**4.4.2 Loading Pattern and Increment.** As cited in the previous sections, the load pattern was two concentrated load, two or four feet apart, depending on the length of the beam to maintain the same levels of maximum shear and moment in the test specimen. The load increment during testing was initially five kips, but was reduced to two and a half kips as the cracking load was approached and until the ultimate load was reached.

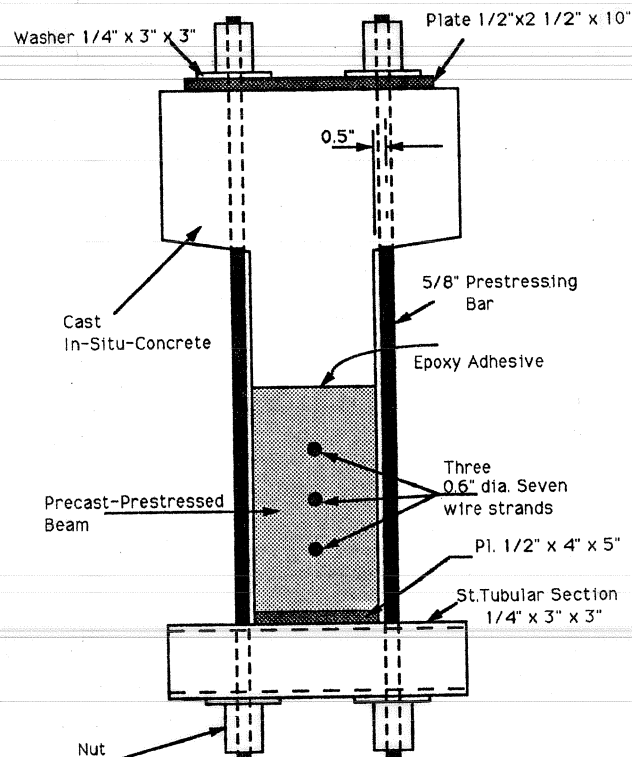

Figure 4.2(a) Retrofitted prestressed composite section.

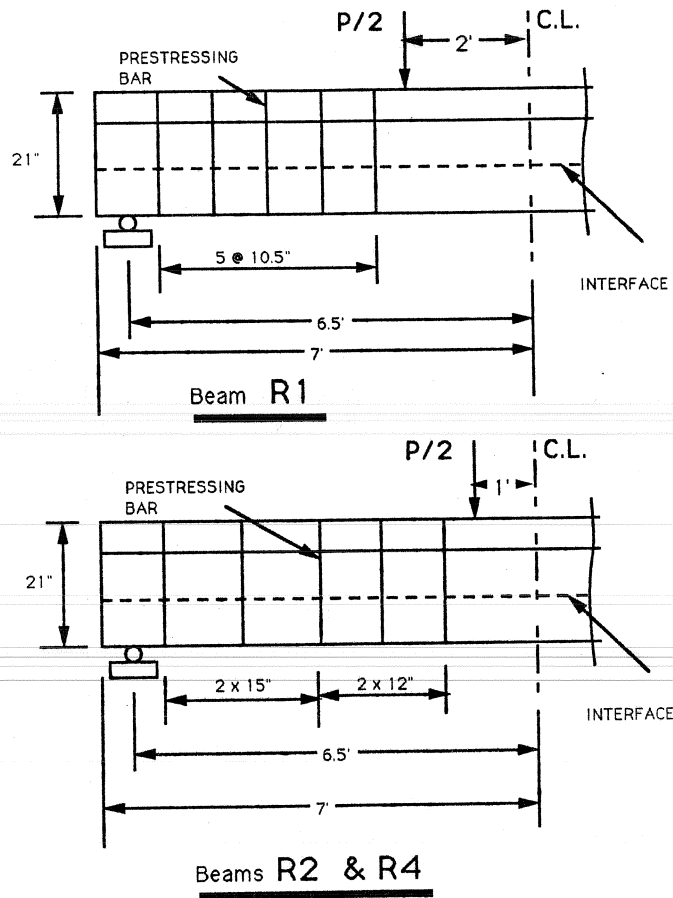

Figure 4.2(b) Locations of prestressing bars for Beams R1, R2 and R4.

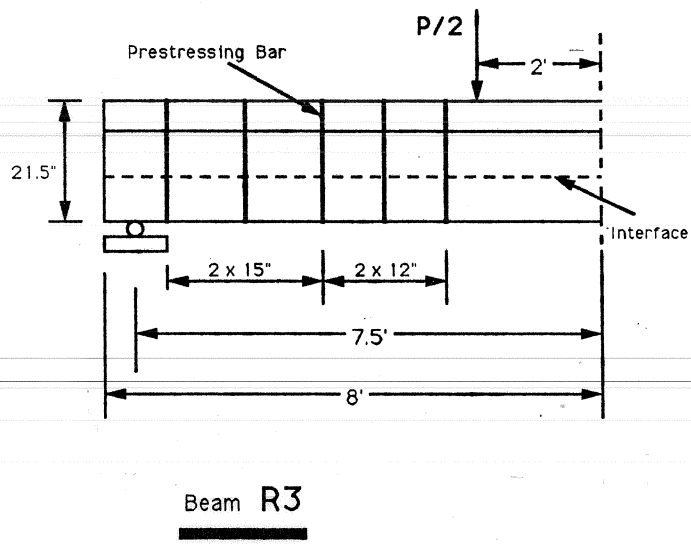

Figure 4.2(c) Locations of prestressing bars for Beam R3.

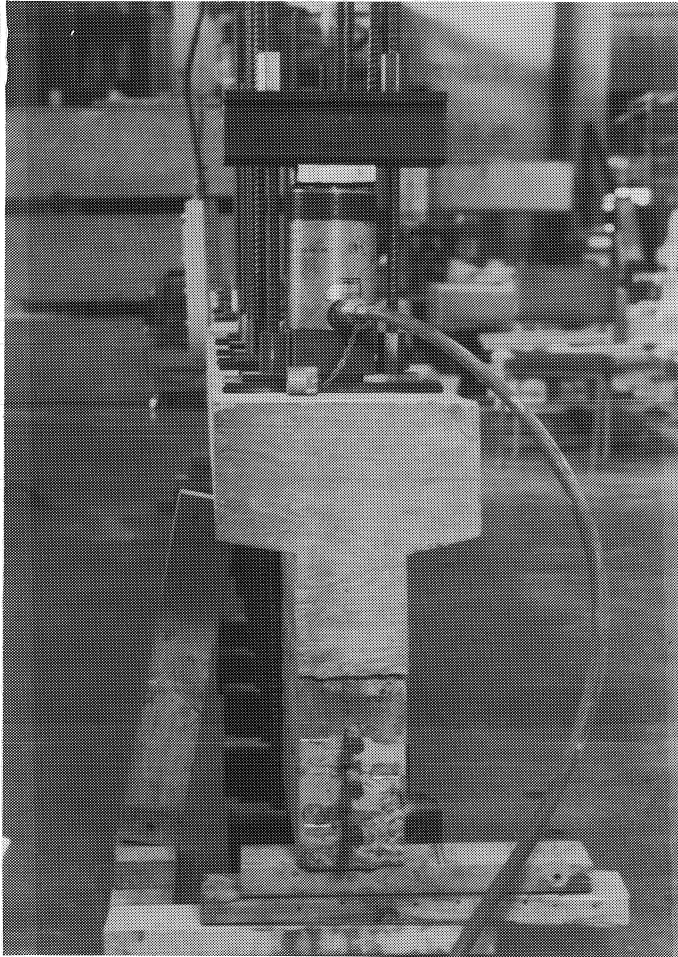

Figure 4.2(d) Tensioning system.



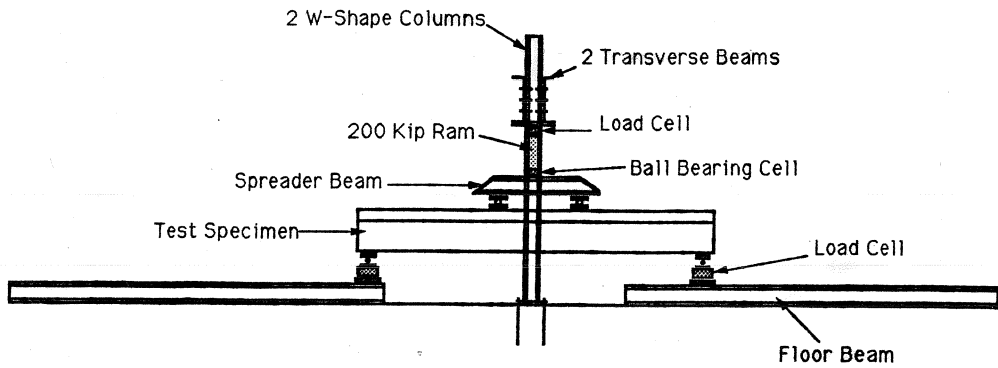

Figure 4.3(a) Test setup.

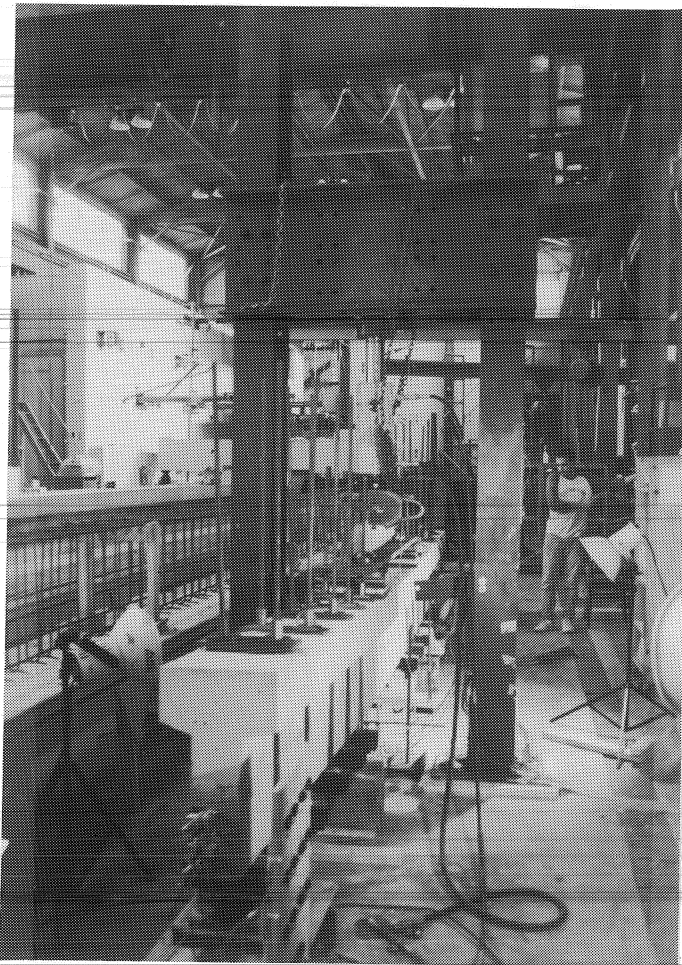

Figure 4.3(b) Test specimen under testing frame.

## CHAPTER FIVE

### Beam Test Results

#### 5.1 General

This chapter presents the results of the test of each of the five beams. The principal variable was the level of stress in the prestressing bars used for retrofit strengthening. Horizontal shear failure was observed at zero and low prestressing levels, and a flexural failure at higher levels as described below.

As cited in the previous chapter these beams were a part of research project studying the transfer and development length of pretensioned strands. For convenience these beams have been renamed as follows:

Names as Cited in this Report	Previous Name
B1	FCT 16212
R1	FC 360 1A
R2	FC 360 3A
R3	FC 360 211A
R4	FC 360 2A

#### 5.2 Beam Tests

*5.2.1 Beam B1 (Type Two - Cross Section, Fig. 4.1b).* Beam B1 was 16 feet long, with a clear span between supports of 15 feet. The precast-prestressed beam was provided with #3 transverse reinforcement at 6.0 inches as shown in Figure 4.1b. No web reinforcement was left protruding from the prestressed beam, across the interface with the cast-in-situ concrete. The beam was loaded with two concentrated loads four feet apart, as shown in Figure 5.1a. Load was applied in five-kip increments. The beam showed elastic behavior before cracking, and deformations were linearly proportional to load. Flexural cracks were first noted at 40 kips applied load. As the load was increased, deformation of the beam began to increase more rapidly than the load, but at a low rate as shown in Fig. 5.1b. After the flexural cracks had formed in the prestressed beam, some cracks started developing in the cast-in-situ portion in addition to the cracks that were extending from the prestressed beam.

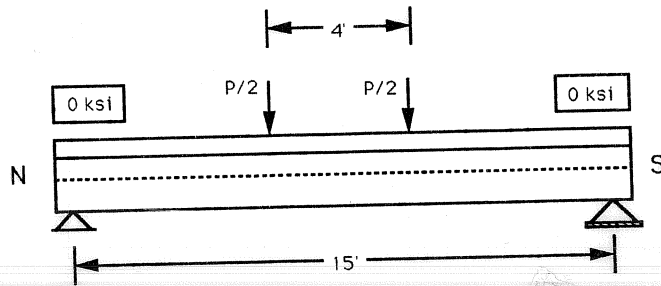

Figure 5.1a Loading pattern, Beam B1.

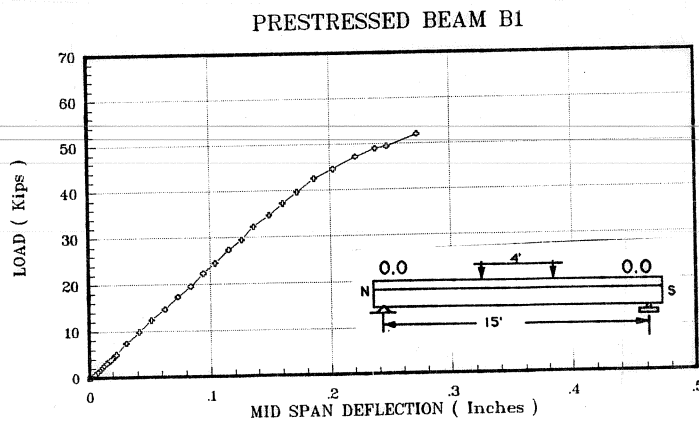

Figure 5.1b Load - Midspan deflection curve.

At a load of 53 kips the beam suddenly failed in shear, the major crack starting from the south load point at an angle of about 45 degrees with the interface as shown in Fig. 5.1c. The bond between the precast-prestressed and the cast-in-situ portion failed from the intercept point of the diagonal crack to the south end. One diagonal crack formed at the

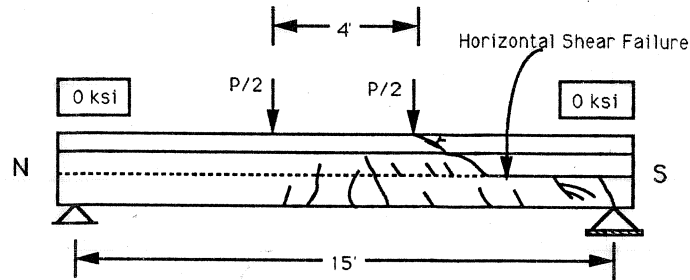

Figure 5.1c Crack pattern, Beam B1.

south support, but at a steeper slope since the prestressed beam was provided with web reinforcement.

No web shear cracks were observed before failure. Figure 5.1c shows the crack patterns. Since the beam did not develop its flexural capacity, the stresses in the prestressing strands were very low and far from yielding. Figure 5.1d shows load versus additional stress in the strands due to external applied load. Zero additional stress in the strand represents the prestressing stress of the strand. End slips of prestressing strands were almost zero at the time Beam B1 failed in horizontal shear at the north end.

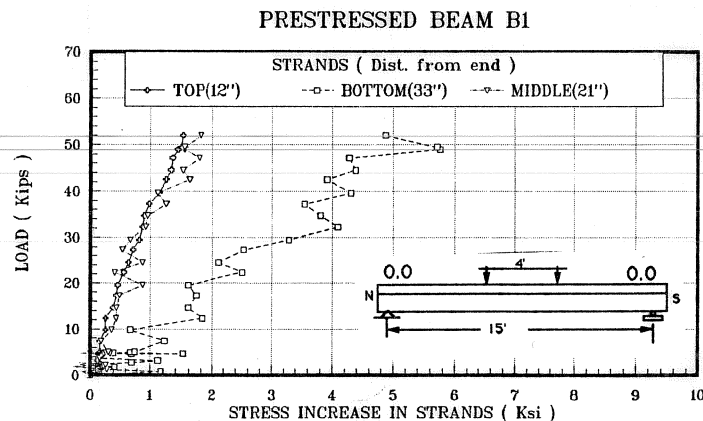

Figure 5.1d Load vs. stresses in strands.

**5.2.2 Beam R1 (Type One - Cross Section, Figure 4.1a).** Beam R1 was 14 feet long, with a clear span between supports of 13 feet. This was the first retrofitted beam, and was strengthened by pairs of 5/8-inch external prestressing bars as shown in Figure 5.2a. Ten pairs of prestressing bars were stressed to 80 ksi, to produce a normal pressure at the horizontal shear interface, and distributed along the shear spans as shown in Fig. 5.2a.

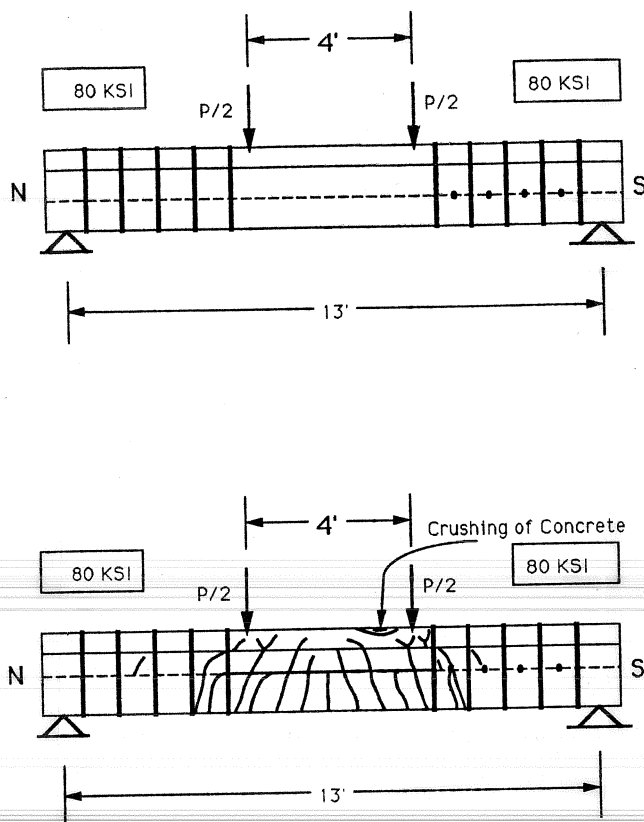

Figure 5.2a Loading and cracking pattern, Beam R1.

Since the beam is prismatic, symmetrical, and symmetrically loaded, it was provided with two different strengthening systems at either ends. At the north end the beam was strengthened with only prestressing bars. At the south end a one-inch diameter hole was drilled into the web at the interface at four points between the external prestressing bars and a 3/4-inch diameter, five-inch long steel bar was inserted into each hole. The gap around the rod was filled with two component epoxy adhesive. Figure 5.2b shows the detail of this horizontal shear insert.

The beam was loaded in the same way as Beam B1. It behaved very well in the elastic range and the first cracking was at a load of 54 kips. Five flexural cracks at the same time were formed at spacing which varied from 9 to 12 inches. These cracks were only in the prestressed beam in the pure flexure region. At 59 kips load cracks developed in the shear spans close to the loads, and at 61 kips load flexural cracks extended into the cast-in-situ concrete portion, along with a new crack which developed in that portion only. Figure 5.2a shows the cracking for Beam B1.

Major cracks were concentrated at two locations between the load point and the first prestressing bar, and between the first two bars. Those cracks were similar at both ends

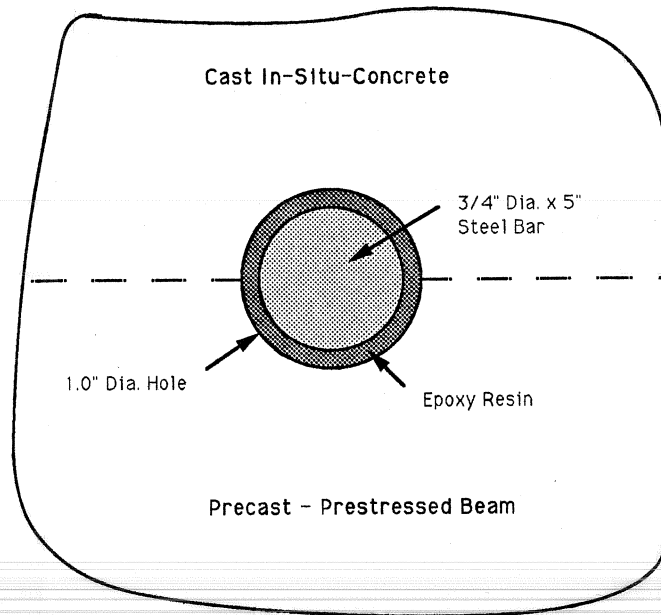

Figure 5.2b Detail of horizontal shear insert.

(but wider at the south end which was provided with horizontal shear steel inserts) which might be due to loss of some concrete at the shear inserts during drilling of holes.

As the flexural cracks started extending into the upper portion of the composite beam, the deflection of the beam increased more rapidly than the load. When the load reached 77 kips, cracks extended into the flange and the beam started deforming more rapidly. Until 80-kip load, no end slip was observed. The major cracks were becoming wider and wider, and at that level of load the strands started yielding, as shown in Fig. 5.2c. At a load of 83 kips, the bond at the interface between the two portions failed within the pure flexure span. This bond failure was arrested by the external prestressing bars and did not extend into the shear span.

As the load was increased, the cracks continued to extend into the flange until the beam failed in flexure and crushing of concrete occurred next to the south load point within the pure flexure span. Midspan deflection at failure was 1.85 inches. Figure 5.2d shows the load versus deflection of the beam. The flexural failure was accompanied by end slip of the prestressing strands as the load exceeded 80 kips. At the south end the slip was about 0.25 inch and at the north end it was about 0.12 inch, as shown in Figs. 5.2e and f. This end slip at both ends is due to loss of bond between strands and concrete in the shear spans at loads above 80 kips. Damage to the concrete in providing the shear inserts would account for the south end being slightly weaker in resistance to end slip as shown in Figure 5.2e.

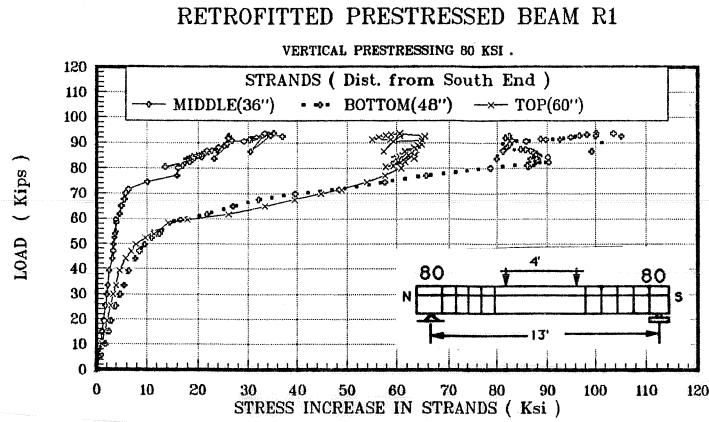

Figure 5.2c Load vs. stresses in strands (south end).

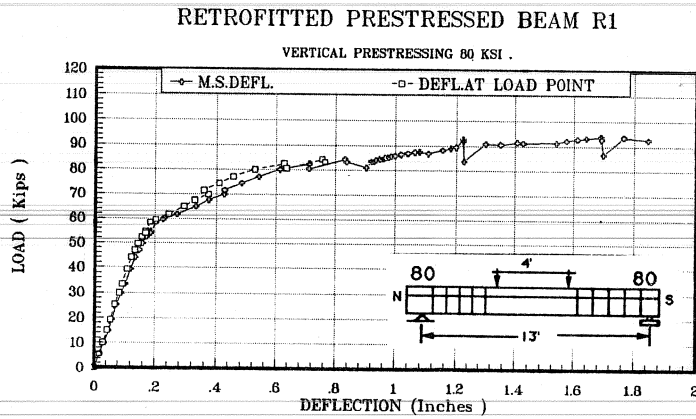

Figure 5.2d Load - deflection curve.

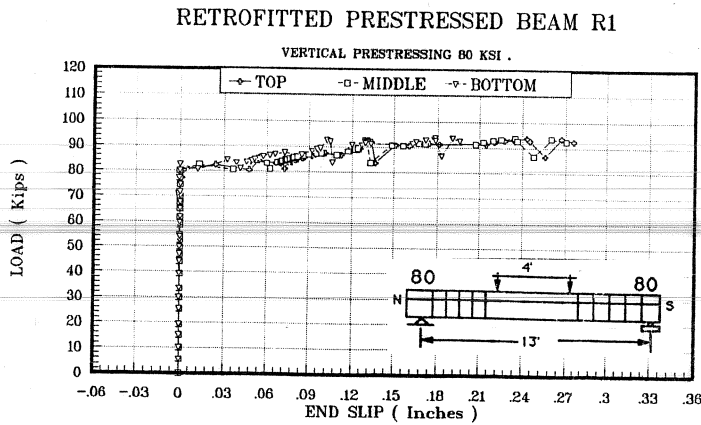

Figure 5.2e Load vs. end slip (south end).

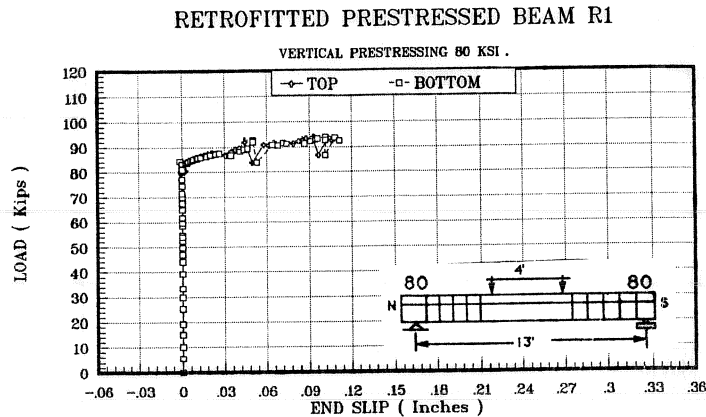

Figure 5.2f Load vs. end slip (north end).

Both ends of this beam were sound until the beam developed its flexural capacity with only 60 inches embedment length for 0.6-inch diameter seven-wire strand, which is usually not enough even for 0.5-inch diameter strands in ordinary prestressed beams. The north end, which was not provided with horizontal shear inserts, behaved better than the other end with horizontal shear inserts. The vertical prestressing of 80 ksi was enough to prevent horizontal shear failure in the beam until the beam developed its flexural capacity at a load of 93.61 kips, although the equivalent average horizontal shear stress at the interface due to this load was about 614.21 psi.

5.2.3 *Beam R2 (Type One - Cross Section, Fig. 4.1a).* Beam R2 was 14 feet long, with a clear span between supports of 13 feet. This beam was retrofitting in the same way as Beam R1. Level of stress in the prestressing bars was reduced to 60 ksi and the spacings between these bars were changed, as shown in Fig. 5.3a, 12 inches between the bars close to the load points and 15 inches for those close to the support. Since the retrofit prestressing bars alone could prevent horizontal shear failure in Beam R1 (80 ksi), no horizontal shear inserts were provided for this beam, nor for the other two beams tested.

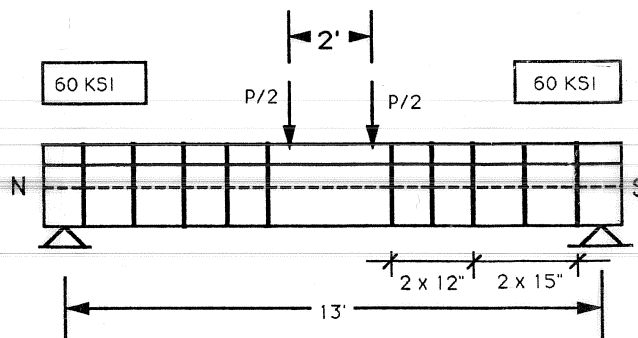

Figure 5.3a Loading pattern.



The beam was loaded with two concentrated loads (Fig. 5.3a) until failure. The spacing between these loads was reduced to two feet, allowing a longer shear span and a larger M/V ratio. The beam showed elastic behavior before cracking, and deformations were linearly proportional to load, as shown in Fig. 5.3b. First cracking developed at a load of 48 kips, and was in the prestressed portion of the beam within the pure flexure span. Five flexural cracks were formed at a spacing of 6 to 8 inches. As the load was increased,

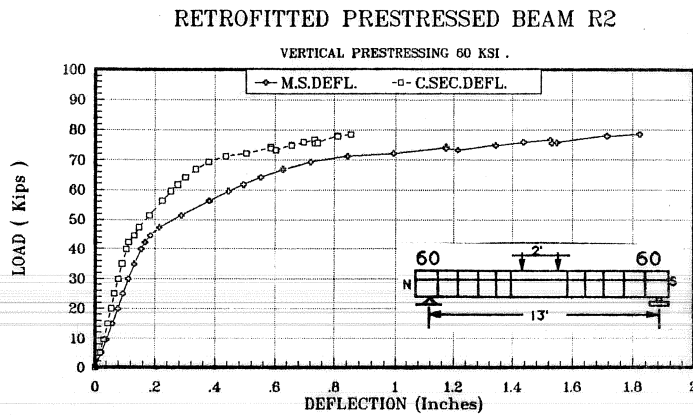

Figure 5.3b Load - deflection curve.

deflection of the beam began to increase more rapidly. At a load of 53 kips, the cracks extended into the upper cast-in-situ concrete portion.

Bond failure was observed at the interface at a load of 61 kips within the pure flexure region. At a load of 70 ksi, the cracks extended into the flange and deflection started increasing at higher rates until failure. Figure 5.3b shows the complete load versus deflection response for Beam R2.

The principal cracks were between the point loads and the first two prestressing bars, as shown in Fig. 5.3c. The mode of failure was flexural failure at a load of 78.57 kips. The

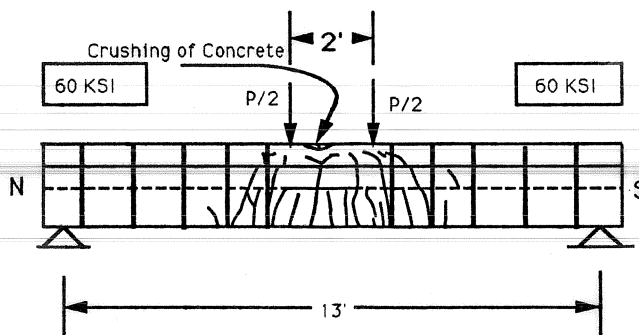

Figure 5.3c Cracking patterns, Beam R2.

equivalent average horizontal shear stress at the interface due to this load was about 515 psi.

End slips of the prestressing strands at both ends were about 0.15 inches, with exception of the end slip of the south-end bottom strand, whose reading was eliminated due to connection error. Figures 5.3d and e show the end slip of strands at both ends of the beam. These figures show that the end slips start at a load of 70 kips; end slips were almost zero below this load.

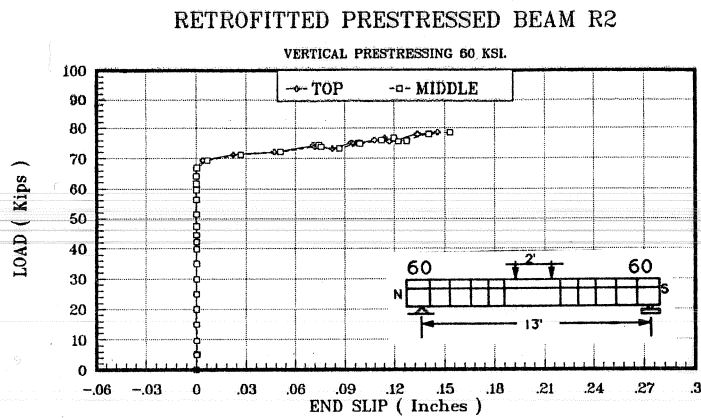

Figure 5.3d Load vs. end slip (south end).

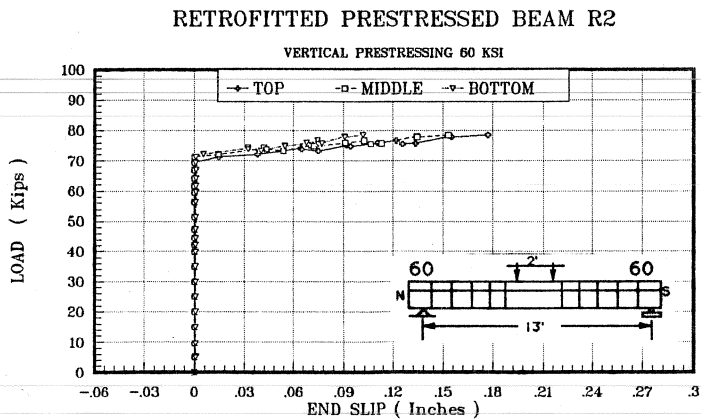

Figure 5.3e Load vs. end slip (north end).

Although Figure 5.3f shows that the measured increase in stress of the strands did not all show yield, the stresses were approaching yield of the strands by the time the beam developed flexural capacity. In this beam strain gages were placed on three prestressing bars to measure the stresses in the bars during the test. The strain gages showed no

Fig.

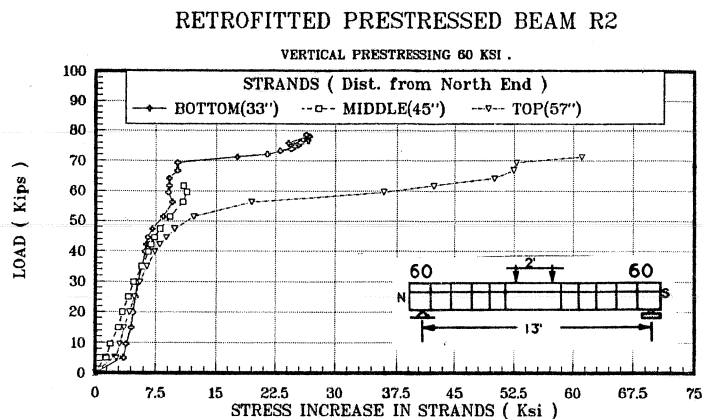

Figure 5.3f Load vs. stresses in strands (north end).

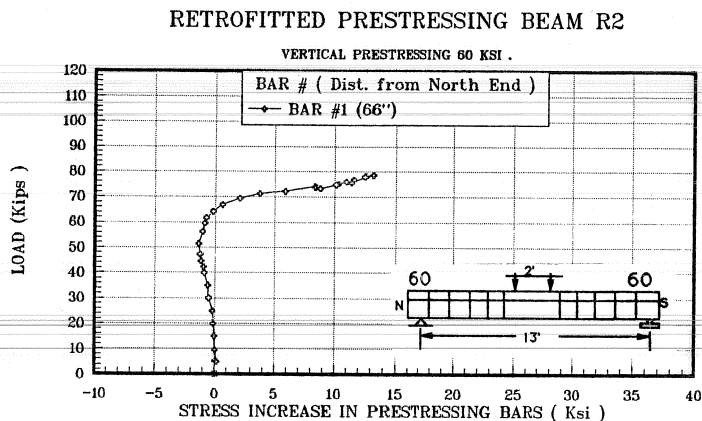

Figure 5.3g Load vs. stresses in prestressing bars (north end).

increase in stresses in the prestressing bars close to the support, but an increase in stresses in the first prestressing bar next to the load point was observed at a load of 66 kips. Measured stresses continued increasing until the member developed its flexural capacity, as shown in Fig. 5.3g.

These results are consistent with the behavior of the beam and the cracking pattern. The major cracks were observed next to the prestressing bar that showed increase in its stresses. On the other hand, the other prestressing bars which are close to support showed no increase in their stresses, and the beam itself was sound until failure, showing no sign of distress.

Development length of the strands in this test was 72 inches. The 60 ksi stress in the transverse prestressing bars, applied external stressing across the interface, developed flexural failure with this short development length.

5.2.4 *Beam R3 (Type Two - Cross Section, Fig. 4.1b).* Beam R3 was 16 feet long, with a clear span between supports of 15 feet. This beam was retrofitted in the same way as the other beams, but since this beam is symmetrical, prismatic, and symmetrically loaded, the prestressing bars on the north shear span were stressed to a different level from those on the south shear span of the same beam. Prestressing bars on the north end were prestressed to 50 ksi and those on the south end to 40 ksi. In this way the behavior of the beam under two different levels of prestressing could be studied in one test. Since this beam is longer than beam R2, the intent was to keep the level of prestressing as a principal variable. The two concentrated loads were set four feet apart to maintain the same level of moments and shear forces in the beam, as well as on embedment length 72 inches. The retrofit prestressing bars were placed in the same pattern and the same spacings as Beam R2.

This beam showed very similar behavior to that of Beam R2 with the exception that the end slips at each end approached 0.3 inches, which is nearly twice the end slip of the strands in Beam R2. Figure 5.4a and b show the end slips of the strands at different load levels.

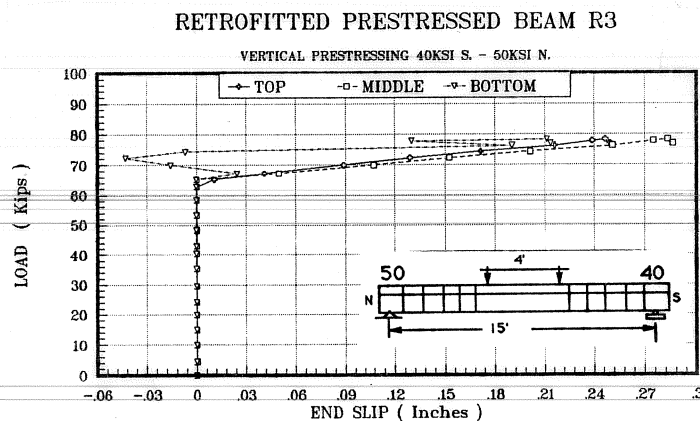

Figure 5.4a Load vs. end slip (south end).

Figure 5.4c shows the load deflection response for Beam R3. It can be seen clearly that the rate of deflection increased after the formation of first cracking at a load of 48 kips. At a load of 59 kips web shear cracks developed in the web in both portions, the prestressed beam and the cast-in-situ concrete. Although the flexural shear cracks were slightly wider than those of Beam R2, the ultimate load was almost the same (78.6 kips), and the mode of failure was a ductile flexural failure. Figure 5.4d shows the cracking pattern of Beam R3.

5.2.5 *Beam R4 (Type One - Cross Section, Fig. 4.1a).* Beam R4 was 14 feet long, with a clear span between supports of 13 feet. the beam was retrofitting with the same post-tensioning technique as the other beams. Prestressing bars were placed in the pattern and the spacings as shown in Fig 4.2b. Prestressing bars on the north shear span were prestressed to 20 ksi and on the south shear span to 40 ksi. The two concentrated loads

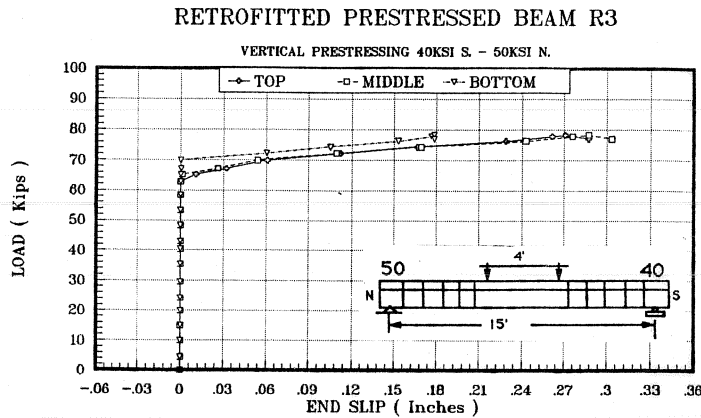

Figure 5.4b Load vs. end slip (north end).

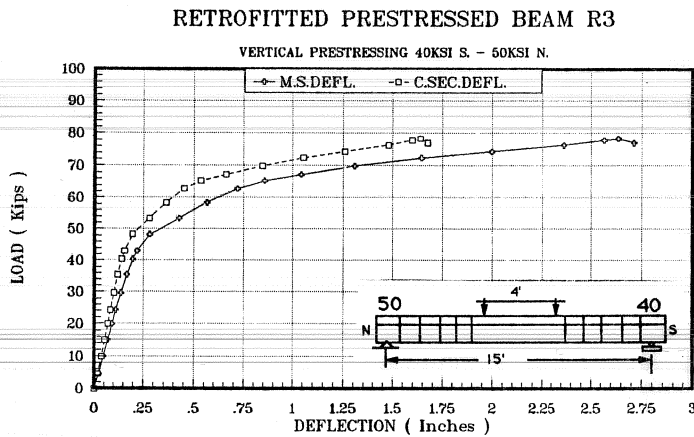

Figure 5.4c Load - Deflection curve.

were kept two feet apart to maintain the same level of moments and shear forces as the previous two beams.

**Mode of Failure.** This beam experienced a horizontal shear failure at the north end, where the prestressing bars were prestressed to only 20 ksi, while the other end stressed to 40 ksi showed no horizontal shear distress. The top cast-in-situ concrete moved horizontally against the precast-prestressed beam by half an inch, at a load of 66 kips, some 11 kips below the estimated flexural ultimate load; Fig. 5.5a shows the displacement at ultimate from horizontal shear failure.

The deflections were linearly proportional to loads before cracking. At a load of 45 kips, three flexural cracks developed in the pure flexure region of the precast-prestressed portion at a spacing of 8 and 10 inches. Afterwards, as the load was increased, the deflection increased more rapidly, as shown in Figure 5.5b. At a load of 50 kips, the cracks extended into the web of the cast-in-situ concrete and then into the flange at 64 kips. Diagonal shear cracks were observed in the middle of the north shear span of the

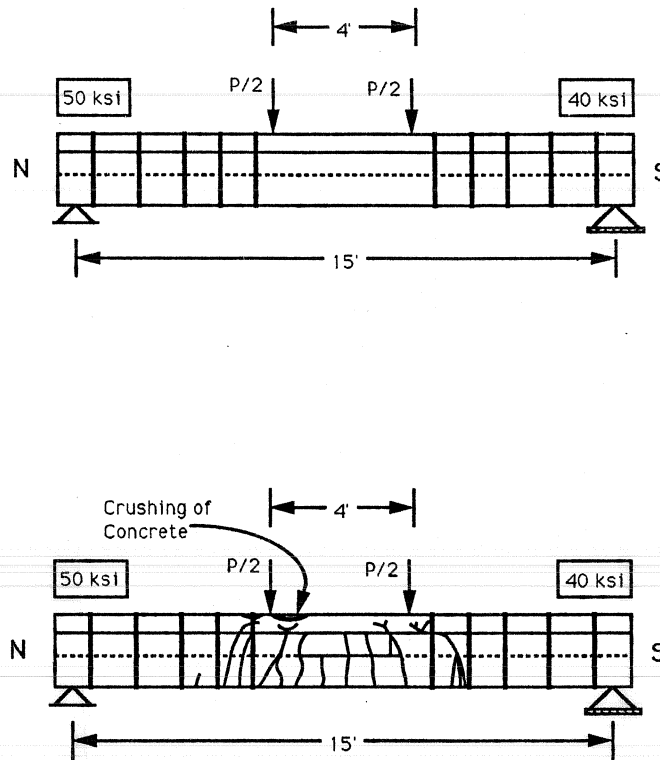

Figure 5.4d Loading and cracking pattern (Beam R3).

prestressed beam at 64 kips when the maximum deflection was less than 0.6 inch. A sudden horizontal shear failure was obtained at 66 kips. Although the equivalent average horizontal shear stress at the interface due to this load was 440 psi, lower than that of any other retrofitted beams. The cast-in-situ concrete portion moved half an inch horizontally against the prestressed beam leaving major diagonal cracks in the beam in both the upper and lower portions, Fig. 5.5c. The beam showed low ductility as compared to the other retrofitted beams, but still it showed a better ductility than that of Beam B1 which had no retrofit reinforcement.

No major cracks were observed in the south shear span where the prestressing bars were tensioned to 40 ksi, although typical flexural shear cracks formed between the first two bars next to the load point, and two fine diagonal cracks in the web of the upper portion. At the south end, the end slip of the strands were almost zero at failure. At the north end, an average end slip of 0.11 inch was measured, Figures 5.5d and e.

From Figure 5.5f, which shows load versus the increase in stresses in the prestressing strand, it is obvious that the stresses were increasing very slowly until the cracks extended into the cast-in-situ concrete. At this stage the stresses started increasing very rapidly. Although the beam failed in horizontal shear, the strands showed a considerable stress increase. The transverse prestressing bars were stressed to only 20 ksi in the north shear



Figure 5.5a Differential movement of the cast-in-situ concrete deck against the prestressed beam due to horizontal shear failure.

span. This was not enough to let the beam develop its full flexural capacity. The south shear span, with 40 ksi transverse stress in the retrofit bars, was undamaged in horizontal shear at this load (88% of ultimate flexural load). Development length in this test beam was 72 inches.

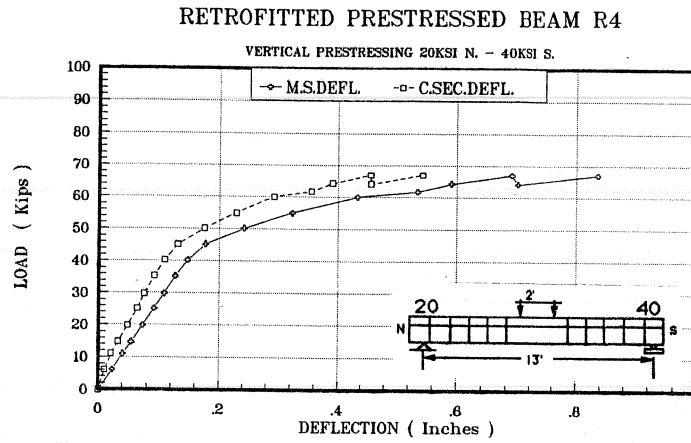

Figure 5.5b Load - Deflection curve.

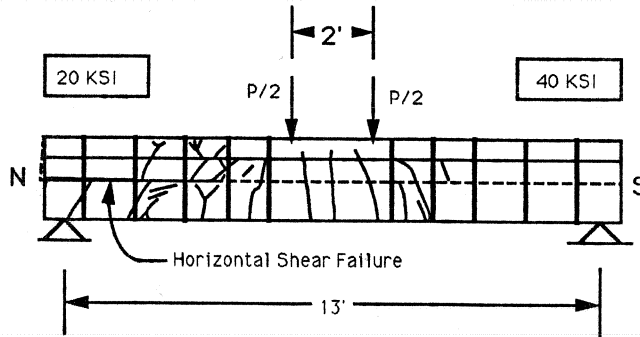
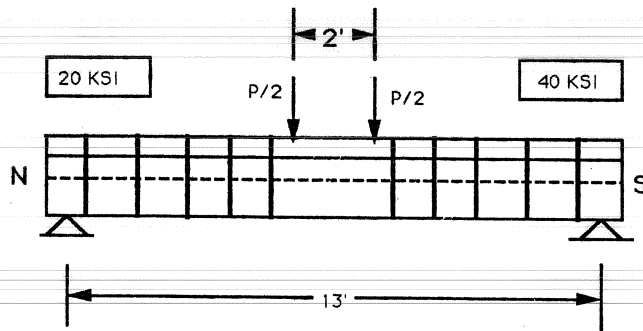

Figure 5.5c Loading and cracking patterns (Beam R4).



RETROFITTED PRESTRESSED BEAM R4

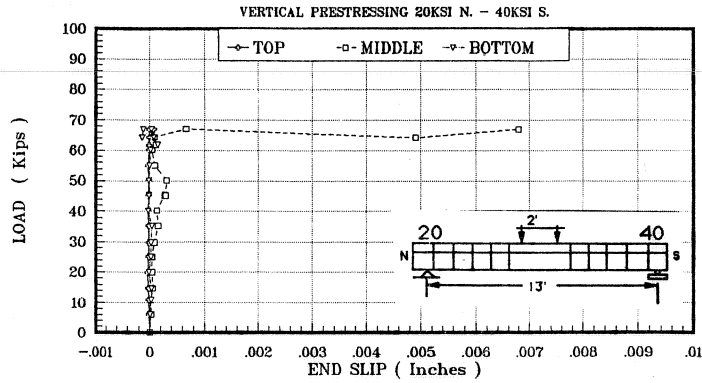

Figure 5.5d Load vs. end slip (south end).

RETROFITTED PRESTRESSED BEAM R4

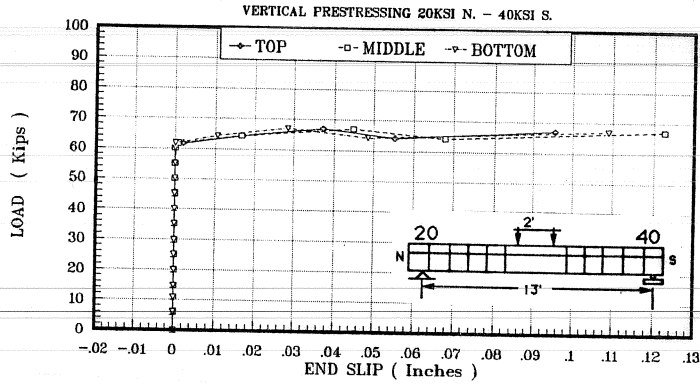

Figure 5.5e Load vs. end slip (north end).

RETROFITTED PRESTRESSED BEAM R4

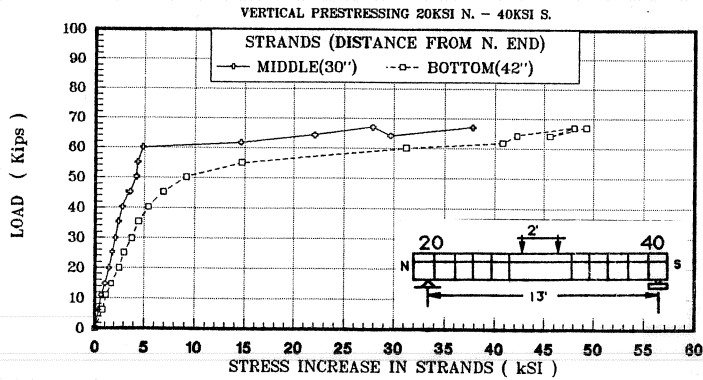

Figure 5.5f Load vs. stresses in strands (north 20 ksi end).

# CHAPTER SIX

## Comparison and Discussion of Test Results

### 6.1 General

In Chapter Five, results of test data for each beam were reviewed. Deflection, cracking, end slip of strands, and stress increase in strands were reported at different levels of loads for each beam. This chapter discusses the results of these beams taking into account the different stress levels in the prestressing bars. Effect of the transverse prestressing bars on the cracking load, required development length and shear strength are also presented. Comparison of the results with previous research and the provisions in ACI 318-89 for the design of prestressed concrete are presented as well.

### 6.2 Deflection

Before cracking of the concrete, all of the beams showed essentially "elastic behavior," including Beam B1 which had no retrofit transverse prestressing system. Deflections were linearly proportional to load, but the presence of transverse prestressing bars increased the cracking load and thus extended the range of elastic action. This increase was nearly 8% for the 14-foot long beams and 22% for the 16-foot long beams.

PRESTRESSED BEAMS B1 & R3

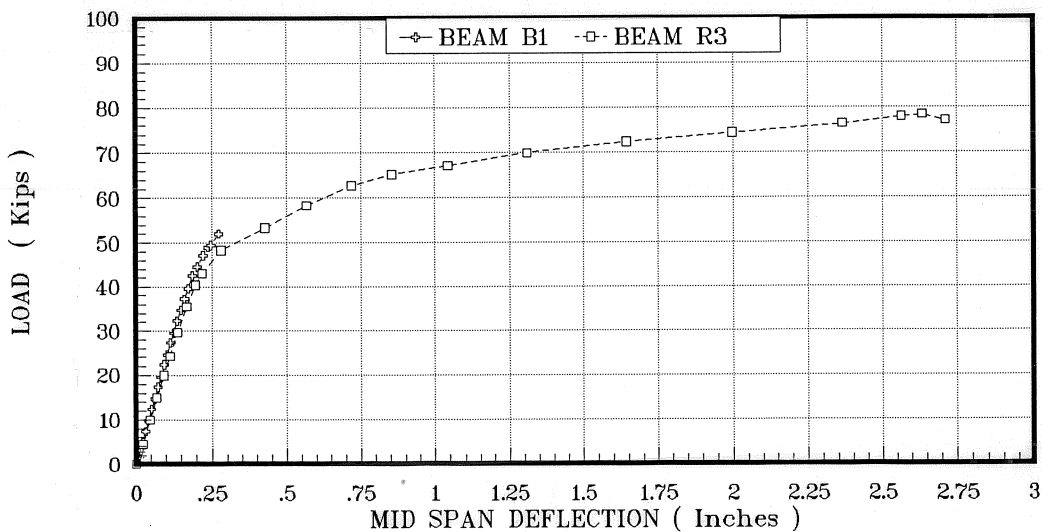

Figure 6.1a Load - Deflection curves, Beams B1 and R3.

Figure 6.1a shows load-midspan deflection curves for the Beams B1 and R3. Both beams are of the same cross section and span. It is quite obvious that the transverse prestressing bars increased the ultimate load and allowed very large deformations before

failure. Both beams behaved similarly before cracking. Figure 6.1b shows Beam R3 under testing frame at ultimate load.

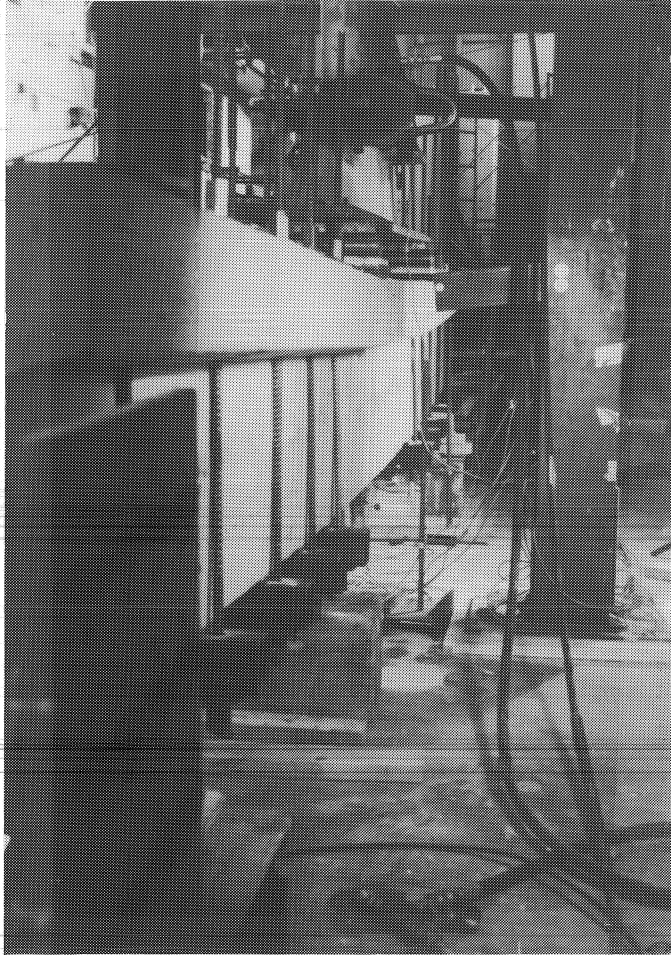

Figure 6.1b Beam R3 under testing frame.

Beams R2 and R4 were similar in cross section, span and pattern of loading. One end of Beam R4 that was transversely prestressed to only 20 ksi failed in horizontal shear at a load equaled to 88% of the ultimate load. Both beams behaved similarly before cracking, but Beam R2 showed high ductility and large deformations before failure. Figure 6.1c shows the load-midspan deflection curves for both beams, and Figure 6.1d shows Beam R2 under testing frame at ultimate load.

### 6.3 Cracking

**6.3.1 Development of Cracks.** In all beams the first cracking was in the pure flexure region, including the beams that failed in horizontal shear. These cracks started in the bottom portion of the precast-prestressed beam and were almost vertical. As the load was

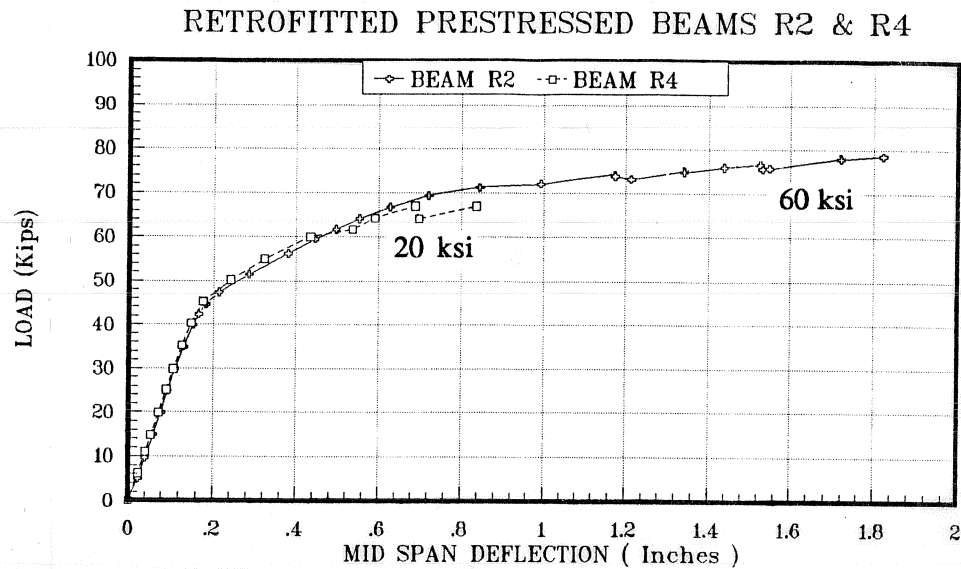

Figure 6.1c Load - Deflection curves, Beams R2 and R4.

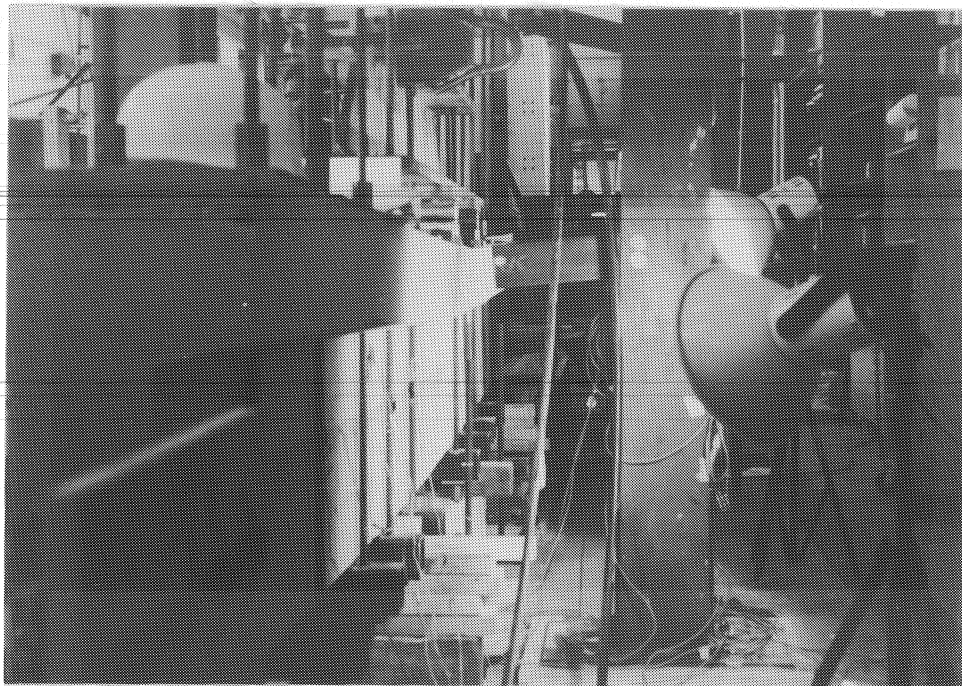

Figure 6.1d Beam R2 under testing frame.

increased, the cracked formed in the shear span region, but they were inclined in the typical manner in the regions subjected to combined shear and flexure. These inclined cracks were at a steep slip in the retrofitted beams and they formed just between the load point and the first two prestressing bars. No inclined cracks were observed in Beam B1 before the sudden horizontal shear failure. As the load was increased, the retrofitted beams showed some fine cracks which developed in the top portion starting from the interface. These cracks were

not lined up with the cracks in the precast-prestressed beam, and could be a first sign of bond failure at the interface.

**6.3.2 Horizontal Cracks.** Horizontal cracks, resulting from bond failure at the interface, occurred in all beams but at different locations and stages. Some of these horizontal cracks affected the behavior of the beam, and others did not. In the case of Beam B1, (without prestressing bars) the horizontal crack occurred at the failure load. In other words, once horizontal shear crack formed, the beam could not take any further load.

Beam R4 was retrofitted with a low level of stress (20 ksi) in the prestressing bars; bond at the interface failed. A differential movement of 0.5 inch was observed at the north

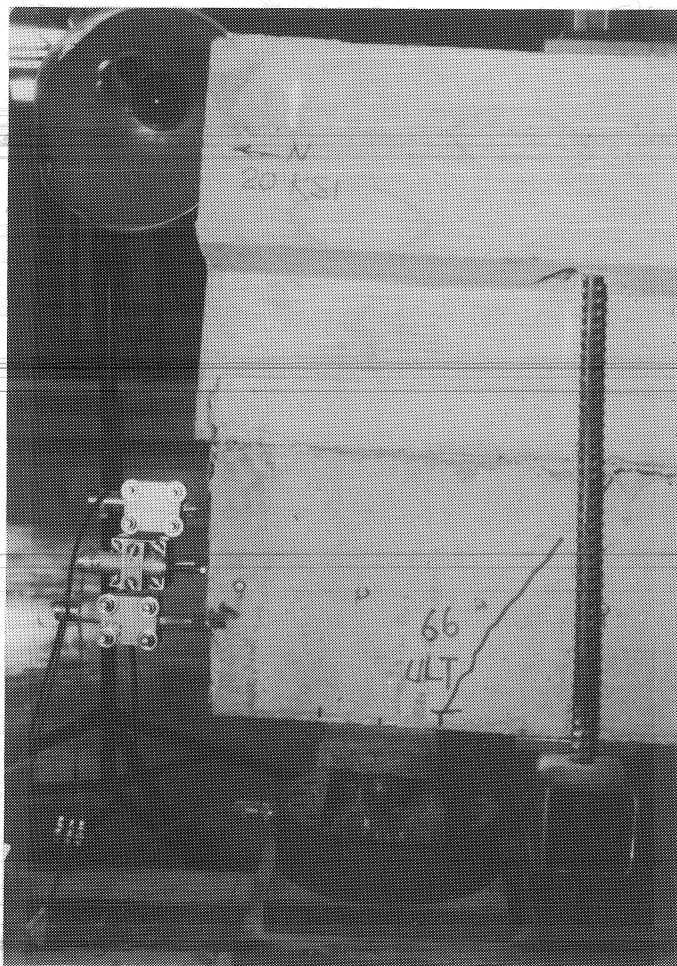

Figure 6.2a North end of Beam R4 at failure.

end, Fig. 6.2a. Beams R1, R2 and R3 failed in flexure; the horizontal crack was observed in every beam within the pure flexure region at a load which varied between 80 to 85% of the ultimate load but it did not cause total failure of the beam. Rather, a local bond failure

occured at the interface, and the prestressing bars were able to prevent it from extending into the shear span region. It is of importance here to mention again that the interface was smooth, and the two surfaces were bonded with epoxy adhesive.

In their study on the behavior of prestressed concrete composite beams, Evans and Parker<sup>6</sup> reported that bonding may be assisted by leaving stirrups protruding from the prestressed concrete, but this is only necessary when the jointing surface is not sufficiently rough in itself, and in that case the bond may still fail in between the stirrups.

The tests conducted here support the conclusion of Evans and Parker. Since the stirrups are "passive," but the prestressing bars are "active", these tests have shown that the retrofit prestressing bar could prevent horizontal shear failure in the shear span region. If prestressing bars had been provided in the pure flexure region, bond failure at the interface would not have occurred there.

Other than the two major cracks between the point load and the first two prestressing bars, the shear span region in all the retrofitted beams were sound, with exception of the north end of Beam R4 (20 ksi) that failed in horizontal shear. As can be seen in Figure

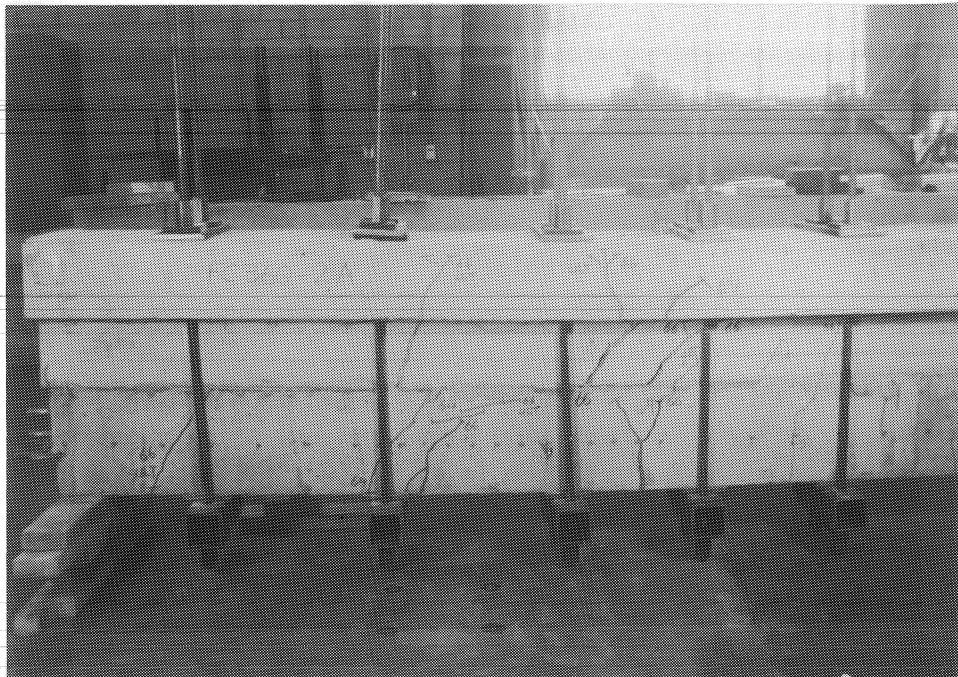

Figure 6.2b Beam R4 before removal of transverse prestressing bars.

6.2b, most of the cracks occurred at the failure load of 66 kips for Beam R4. Although this end failed in horizontal shear, the crack at the interface could not open due to the presence of the prestressing bar. But it opened immediately after the transverse prestressing was released. Widening of this crack after the removal of prestressing bars is due to the

presence of the prestressing strands, which straighten the precast-prestressed portion of Beam R4. Figures 6.2b and c show the north end of Beam R4 before and after the removal of the prestressing bars.



Figure 6.2c Beam R4 after removal of transverse prestressing bars.

## 6.4 Development Length<sup>23</sup>

The distance over which the effective prestress  $f_{se}$  is developed in the strand is called transfer length. An additional bond length is required so that a stress  $f_{ps}$  may be developed in the strand at ultimate flexural strength of the member. This additional length is called flexural bond length. The sum of these two lengths is referred to as the development length of the strand. The development length for prestressing strands is intended to provide bond integrity for developing the strength of the member in flexure.

**6.4.1 AASHTO/ACI - Code Provisions.** The AASHTO/ACI-Code provisions are based on tests performed on normal weight concrete members with a minimum cover of 2 inches. The expression for development length  $l_d$ ,

$$l_d = \left( f_{ps} - \frac{2}{3} f_{se} \right) d_b$$

where  $l_d$  and  $d_b$  are in inches, and  $f_{ps}$  and  $f_{se}$  are in kips per sq. inch. This expression for  $l_d$  may be rewritten as:

$$l_d = \frac{f_{se}}{3} d_b + (f_{ps} - f_{se}) d_b$$

The first term represents the transfer length of the strand, and the second term represents the flexural bond strength. The variation of strand stress along the development length of the strand is shown in Figure 6.3.

The expression for transfer length, and for the additional bonded length necessary to develop an increase in stress of  $(f_{ps} - f_{se})$  are based on tests of members prestressed with clean 1/4-, 3/8-, and 1/2-inch diameter strands for which the maximum value of  $f_{ps}$  was 275 ksi<sup>4</sup>. No tests on 0.6-inch strand were carried out by those investigators; thus the AASHTO/ACI-expression cannot be considered applicable to 0.6-inch diameter strand. It has been shown that transfer length and development length increase almost linearly with strand diameter. Hanson and Kaar<sup>22</sup> explain that larger diameter strands can develop more axial force when stressed to allowable capacity. To prevent average bond stress from reaching a limiting bond stress, a longer development length is required for 0.6 in. than for 0.5 in. diameter strands. The term "limiting bond stress" refers to the minimum average bond stress required to cause failure of bond between concrete and steel.

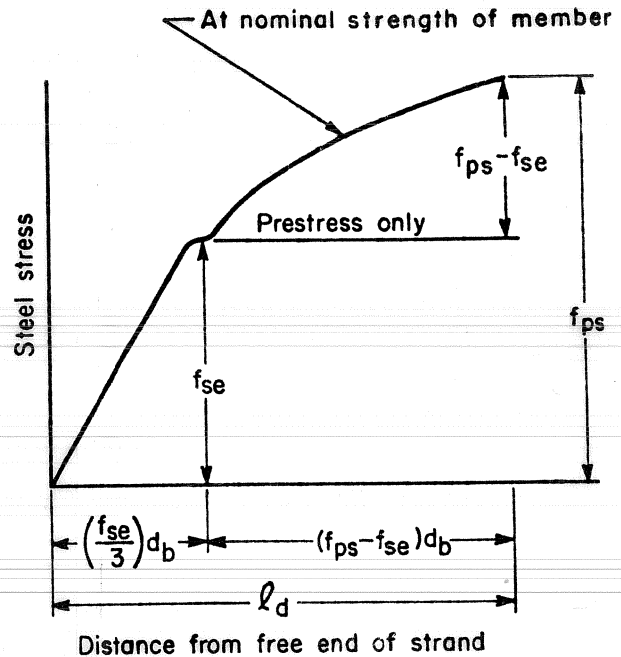

Figure 6.3a Variation of steel stress with distance from free end of strand (Ref. 4.)

According to AASHTO/ACI code requirement, the transfer length would be 51 strand diameters and the flexural bond length would be 119 strand diameters for 270 ksi grade strand, assuming an initial prestress of  $0.7 f_{pu}$  and a 20 percent loss of prestress. Martin and Scott<sup>39</sup> proposed a transfer length of 80 diameters for strands of all sizes, and a flexural bond length of 160, 187, and 200 diameters for the 1/4-, 3/8-, and 1/2-inch diameter strands, respectively. Similarly, the equation for development length proposed by Zia and Mostafa<sup>23</sup> leads to a transfer length of nearly 68 strand diameters, and flexural bond length of 135 strand diameters for a 0.6-inch diameter strand.

**6.4.2 Effect of Transverse Prestressing on the Required Development Length.** As summarized in the previous section, the required development length according to many



investigators varies between 170 and 280 strand diameter for 0.5 strand diameter. These figures are supposed to be higher for 0.6 inch strand diameter, since a longer development length is required for larger strand diameter.

Test results of Beam R1 showed that the flexural capacity of the beam could be developed with a development length of only 60 inches (100 strand diameter), when applying a transverse prestressing of 829.6 psi. Beam R3 was loaded until it developed its flexural capacity with a development length of only 72 inches (120 strand diameters), and transverse prestressing of 339.4 psi. This considerable reduction in the required development length is due to the precompression of the concrete confining the strands which could be assumed uniformly distributed along the shear span since bearing plates were used to distribute the transverse prestressing force on the concrete surface without exceeding its allowable bearing stresses.

**6.4.3 End Slip.** End slip test results show that the end slip decreases with the increase of the transverse prestressing force. Although the end slips are larger than usual for prestressing strands with development lengths according to ACI-Code, still the test beams developed their flexural capacities.

Larger end slips were observed at the north end of Beam R4 (20 ksi) than the south end (40 ksi) due to the smaller transverse prestressing force at the north end. Although the south ends of Beam R3 and R4 were prestressed to the same level of transverse force, the south end of beam R3 showed much larger end slips since the beam was loaded to a higher load and developed its flexural capacity, while Beam R4 failed in horizontal shear at a lower load. It has been observed that for Beams R1, R2, and R3, the end slip of strands started at a load equal to 85-90 percent of the ultimate load. In the case of Beam R4, some end slip was recorded at the north end, but wasn't appreciable since the beam failed in shear at lower load than flexural capacity. Table 6.1 shows the maximum end slip recorded just before failure for all of the five beams tested in this series.

**6.4.4 Corrosion of Strands.** Strand with a slightly rusted surface can have an appreciably shorter transfer length than clean strand, and consequently a shorter required development length. Concrete was removed from the transfer zone at the end of the beams to check whether the strands showed any sign of rust that might have contributed to reduction in the required development length. Figure 6.4 shows that the portion of the strand that is embedded in the concrete is clean and shows no sign of rust, while the exposed portion of the strands shows some sign of rust. The extension of strands beyond the end of the beam has no effect on the development.

## 6.5 Mode of Failure

Ductile flexural failure is a more favorable mode of failure since it gives an obvious warning and sign of distress before failure, while on the other hand shear failure is a violent

Beam	Transverse Prestressing (ksi)		$L_d$ (in.)	Strand	End Slip (in.)		Average End Slip (in.)		Mode of Failure
	North	South			North	South	North	South	
B1	0.0	0.0	72	Top	0.0	0.0	0.0	0.0	Horizontal Shear Failure (south)
				Middle	0.0	0.0			
				Bottom	0.0	0.0			
R1	80	80	60	Top	0.106	0.277	0.173	0.248	Flexural Failure
				Middle	0.300	0.270			
				Bottom	0.112	0.196			
R2	60	60	72	Top	0.177	0.145	0.197	0.197	Flexural Failure
				Middle	0.153	0.153			
				Bottom	0.101	0.292			
R3	50	40	72	Top	0.287	0.249	0.256	0.250	Flexural Failure
				Middle	0.303	0.286			
				Bottom	0.178	0.214			
R4	20	40	72	Top	0.954	0.0008	1.089	0.023	Horizontal Shear Failure (north)
				Middle	1.225	0.0680			
				Bottom	1.089	-0.0012			

and sudden failure. This research work has shown that using transverse prestressing, a sudden shear failure can be changed to a ductile flexural failure associated with reasonable deformations before failure. All shear failures obtained were in the form of horizontal shear failure, through sliding of the cast-in-place concrete against the precast-prestressed concrete beam. All the flexural failures occurred by crushing of concrete in the pure flexure region. Flexural cracks continued to widen with the increase of load and penetrated the compression zone until the stresses in the concrete were sufficiently high to crush the concrete.

Beams which failed in shear showed essentially the same initial pattern of cracking as those which failed in flexure. Before the concrete in the compression zone crushed or the prestressing strand failed (before the beam reached its full flexural capacity), horizontal shear cracking formed suddenly at the interface without exhibiting any warning.



Figure 6.4 Portion of the strands in the transfer zone after removal of concrete.

Figures 6.5a-d show Beams R1 through R4 at failure. Although R4 was retrofitted with external prestressing bars, it failed in horizontal shear as shown in Fig. 6.5d. The level of transverse prestressing force should be high enough to prevent horizontal shear failure.

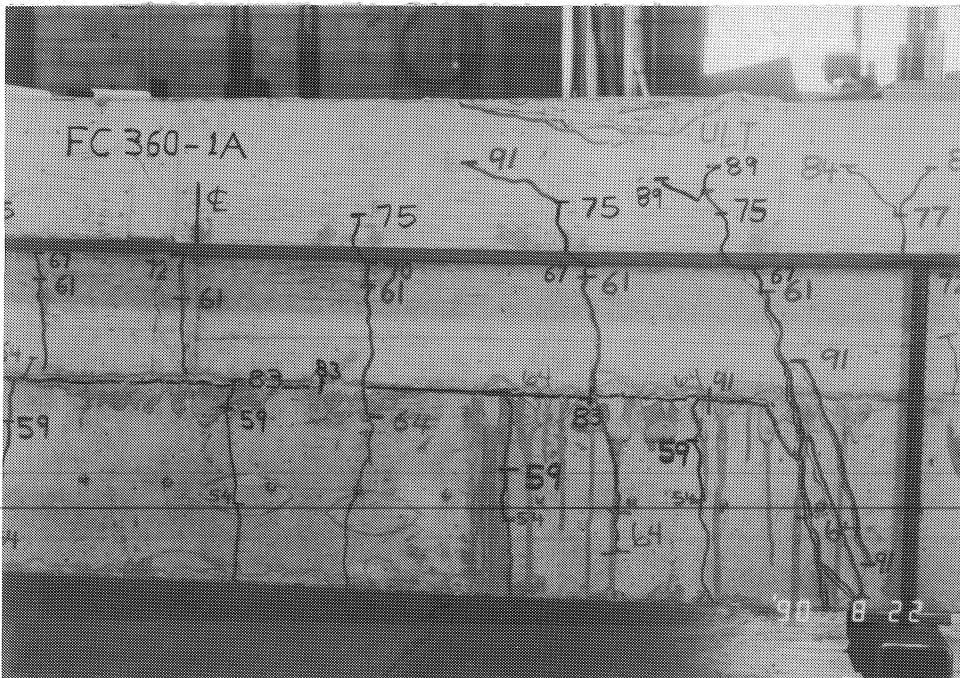

Figure 6.5a Mode of failure of beam R1 (flexural failure - crushing of concrete).

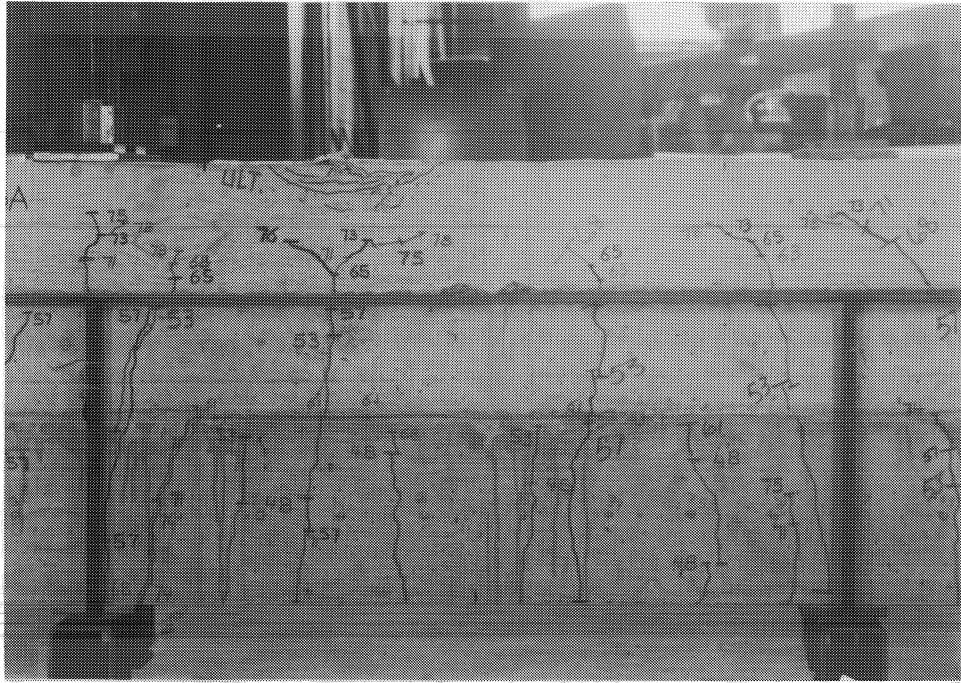

Figure 6.5b Mode of failure of Beam R2 (flexural failure - crushing of concrete).

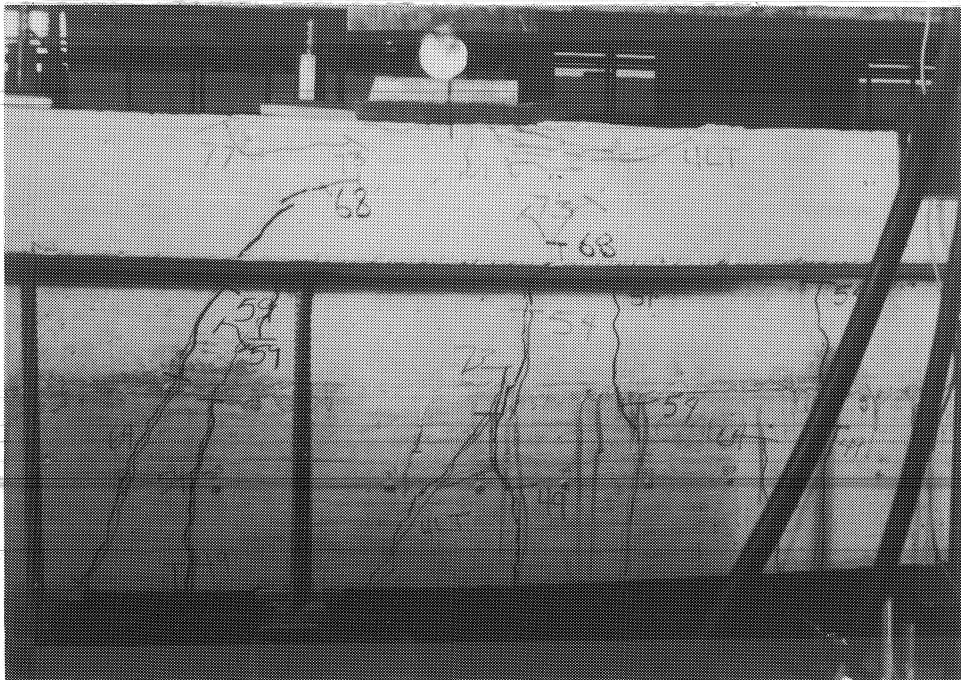

Figure 6.5c Mode of failure of Beam R3 (flexural failure - crushing of concrete).

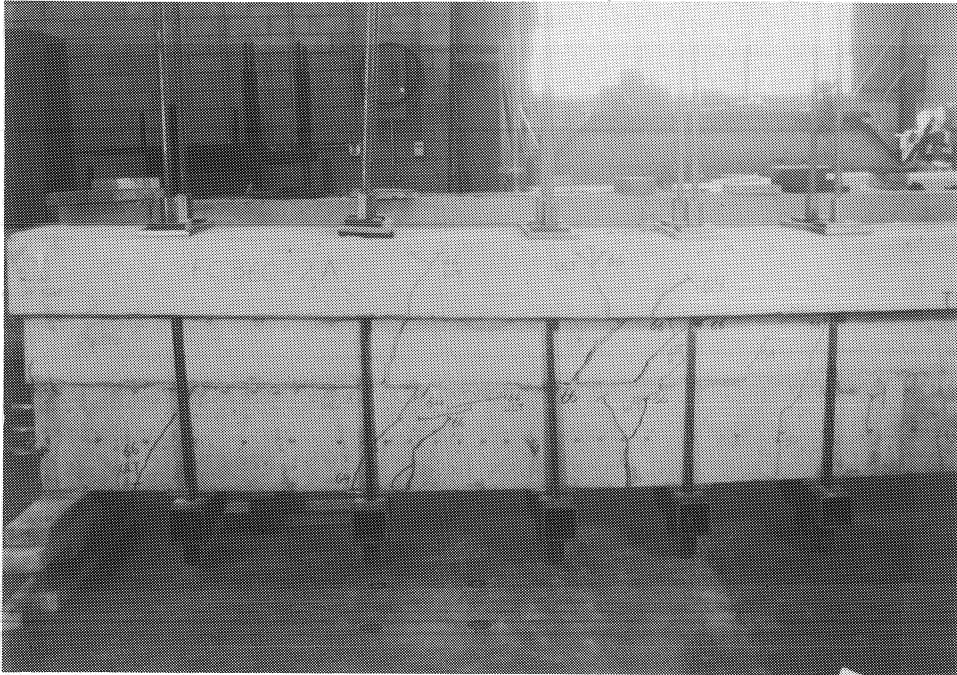

Figure 6.5d Mode of failure of Beam R4 (horizontal shear failure - differential movement).

The stresses normal to the interface plane due to external prestressing force, multiplied by the coefficient of friction between the two surfaces, should be higher than the horizontal shear stresses due to external loading to avoid horizontal shear failure. Appendix D shows calculations of the horizontal shear stresses.

## 6.6 Stresses in Strands

Test results showed that stress increases in strands of beams which failed in flexure were higher than those which failed in shear. Since Beam B1 failed in shear at a load much lower than the load at flexural failure, the stresses in Beam B1 strands were much lower than for other beams. Although Beam R4 failed in shear, it showed much higher stress increases in strands than Beam B1 due to the external transverse prestressing bars.

Beam R1 showed a very high stress increase in the strands. Strain gages were placed on the strand on the south end of the beam, which experienced serious cracks, some local bond failure, and more end slip than the north end.

## 6.7 Ultimate Strength

### 6.7.1 Evaluation of Ultimate Shear Strength Under Biaxial Compression<sup>41</sup>.

**6.7.1.1 Diagonal Shear.** When tensioned stirrups are used, stresses  $f_n$  are applied normal to the horizontal faces, and these either reduce or eliminate the tensile stress. The stresses  $f_n$  to be applied are usually small. In effect, the principal tensile stress is given by:

$$f_t = \frac{f_x + f_n}{2} - \left[ \left( \frac{f_x - f_n}{2} \right)^2 + v^2 \right]^{\frac{1}{2}}$$

For this stress to be equal to zero it follows that:

$$\left( \frac{f_x + f_n}{2} \right) = \left( \frac{f_x - f_n}{2} \right) + v^2 \quad \text{or} \quad f_x \cdot f_n = v^2$$

This relationship is demonstrated in the MOHR'S circle shown in Fig 6.6, in which it is assumed that the principal tensile stress is zero. For this state of affairs, a vertical compression of  $f_n > v^2/f_x$  must be applied. In the case of a composite section, this is not quite true over the whole section at the same level since  $f_x$  in the prestressed beam is due to prestressing force, while  $f_x$  in the top cast-in-situ concrete portion is due to external loads. But both portions exhibit higher shear strength since both are subjected to  $f_x$  and  $f_n$ , although not of similar ratios of  $f_x$  to  $f_n$ .

Since normal stresses  $f_x$  and  $f_n$  in the prestressed concrete beam are constant all over the prestressed section (prestressing force is concentric), the available maximum principal tensile strength is high and constant all over the section. In the top cast-in-situ concrete portion the normal stresses  $f_x$  due to external load are not constant all over the section, they are almost zero or

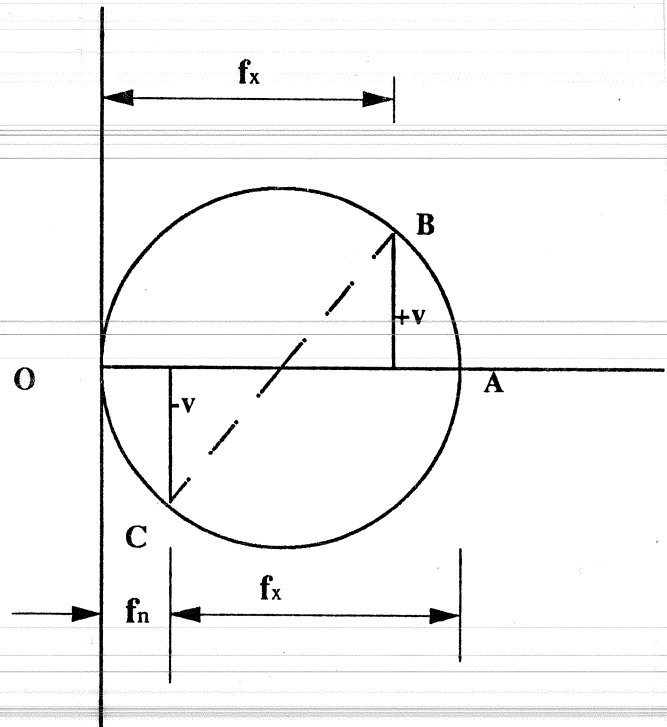

Figure 6.6 MOHR'S Circle for status of principal tensile stresses equal to zero.

tension at the bottom fibers of this portion. This may be the reason for the development of small web cracks that were observed in beam between the second and third prestressing bars in the bottom part of the cast-in-situ concrete portion.

It can be concluded that, in composite sections with transverse prestressing, the top deck behaves as an ordinary reinforced concrete section with transverse prestressing and exhibits less shear strength than the precast prestressed portion, which is prestressed in both X and Y directions.

**6.7.1.2 Horizontal Shear.** If the top surface of the precast-prestressed beam is roughened enough, the composite section will exhibit good horizontal shear strength at the interface. But if it is kept smooth, then bond failure at the interface will probably occur.

Using external post-tensioning bars considerably increases the horizontal shear strength of composite sections, particularly the ones tested in this study with smooth interface which lack adequate shear reinforcement. The external transverse prestressing stress creates an additional horizontal shear strength equal to the force multiplied by the coefficient of friction at the interface. The level of the external transverse prestressing stress should be increased to overcome the horizontal shear stresses at the interface due to external load, differential shrinkage and creep. Tables 6.2, 6.3 and 6.4 show the horizontal shear stresses at the interface at failure of each individual beam and the transverse stresses normal to the interface due to the external prestressing forces. Appendix C shows the shear forces and capacities for test beams.

Station	Distance from Support (feet)	$V_h$ Beam B1 (psi)	Transverse Prestress Normal to Interface		$V_h$ Beam B3 (psi)	Transverse Prestress Normal To Interface	
			Beam B1 (psi)			Beam R3 (psi)	
			North	South		North	South
1	1.0	369.30	0.0	0.0	540.10	407.30	339.40
2	2.5	366.60	0.0	0.0	537.00	407.30	339.40
3	4.0	362.70	0.0	0.0	533.0	407.30	339.40
4	5.5	359.20	0.0	0.0	530.50	407.30	339.40

**6.7.2 Evaluation of Ultimate Flexural Strength.** Test results proved that external transverse prestressing can improve the behavior of composite beams and ensure that they develop their full flexural capacities. But it does not increase the ultimate flexural capacity. As observed by many investigators<sup>11, 16</sup> the test results showed that the external transverse prestressing slightly increases the cracking load of the flexural members. Table 6.5 shows

Table 6.3 Horizontal Shear Stress and Transverse Prestress at the Interface, Beam R1.					
Station	Distance from Supprt (feet)	$V_{max}$ (kips)	$V_h$ (psi)	Transverse Prestress Normal to Interface, Beam R1 (psi)	
				North	South
1	1.0	47.80	618.70	829.60	829.60
2	2.5	47.70	616.70	829.60	829.60
3	3.5	47.30	616.70	829.60	829.60
4	4.5	47.10	609.70	829.60	829.60

Table 6.4 Horizontal Shear Stress and Transverse Prestress at the Interface, Beams R2 and R4							
Station	Distance from Support (feet)	$V_h$ Beam R2 (psi)	Transverse Prestress Normal to Interface Beam R2 (psi)		$V_h$ Beam R4 (psi)	Transverse Prestress Normal To Interface Beam R4 (psi)	
			North	South		North	South
1	1.0	519.50	509	509	44.70	169.70	339.40
2	2.5	516.60	509	509	441.60	169.70	339.40
3	4.0	513.50	509	509	439.20	169.70	339.40
4	5.5	510.50	509	509	435.70	169.70	339.40

comparison between test results and the cracking and ultimate moments according to ACI 318-89.

It can be seen from Table 6.5 that the test ultimate moments are in agreement with the ultimate moment calculated according to ACI 318-89. The test cracking moments are slightly higher than the cracking moments according to ACI 318-89. Appendix B shows calculations of cracking and ultimate moments for the test beams.



Table 6.5 Comparison of the Test Cracking and Ultimate Moments with the AASHTO/ACI-Code Provisions.

Beam (#)	Transverse Prestressing (ksi)		$L_d$ (in.)	Cracking Moment, $M_{cr}$ (kip-in.)		Ultimate Moment, $M_{ult}$ (kip-in.)		Mode of Failure		
	North	South		Test	Code	Test/Code	Test		Code	Test/Code
B1	0.0	0.0	72	1320	1428	0.92	1716*	2570	0.67	Horizontal Shear Failure (south)
R1	80	80	60	1458	1440	1.01	2527	2526	1.00	Flexural Failure
R2	60	60	72	1584	1440	1.10	2592	2526	1.03	Flexural Failure
R3	50	40	72	1584	1440	1.11	2542	2570	0.99	Flexural Failure
R4	20	40	72	1485	1428	1.03	2211*	2526	0.88	Horizontal Shear Failure (north)

\*Moment at failure.

## **CHAPTER SEVEN SUMMARY AND CONCLUSIONS**

### **7.1 Summary**

Many shear strengthening techniques can be utilized for retrofitting of prestressed flexural members. Prestressed concrete composite flexural member that lack shear reinforcement or shear connectors can be retrofitted and develop their full flexural capacity, while avoiding sudden shear failure.

This report presented some strengthening techniques that can be used to retrofit prestressed concrete composite flexural members in general, and in particular the utilization of external post-tensioning systems for strengthening such beams in shear.

Five test specimens were strengthened at different external prestressing levels and tested in flexure. Behavior of these beams were discussed and compared with the ACI 318-89 provisions. Behavior of companion beams were compared to determine the effects of transverse post-tensioning.

### **7.2 Conclusions**

Based on the test results of this study, the following conclusions were derived and include:

1. In composite construction, it is recommended that the top surface of the precast-prestressed beam should be always roughened to ensure good bond at interface between this beam and the cast-in-situ concrete deck.
2. External post-tensioning can successfully be used to improve shear strength of prestressed concrete composite flexural members that lack shear reinforcement. Horizontal shear failure can be prevented if the total transverse prestressing force on a shear span is greater than the horizontal shear force.
3. Using external prestressing stirrups increased the cracking load slightly. The difference is not significant for design. The ultimate load capacity of prestressed flexural members was not exceeded.
4. Due to the confinement of prestressing strands by the external prestressing stirrups, development lengths for the strands as short as 50% of recommended values can be used and the beam can still develop its full flexural capacity.

5. External prestressing stirrups allowed the beam to develop its flexural capacity with short development length, but with some end slip at failure load.
6. Web shear cracks were avoided by using external prestressing stirrups. The end region of the retrofitted test specimens showed no sign of distress in the concrete.
7. Observed flexural shear cracks in retrofitted beams were steeper than those in the unretrofitted beam. That is due to the presence of the external prestressing stirrups at spacings smaller than the depth of the beam.
8. External prestressing stirrups can prevent bond failure at the interface wherever they are provided along the span, provided that they develop enough normal stress on the interface to prevent horizontal shear failure. If cracks at the interface are to be prevented, external prestressing stirrups should be provided in the pure flexure region.
9. Stresses in strands in beams which failed in shear are lower than those in beams which failed in flexure since the loads were lower than the ultimate flexural loads.
10. External prestressing stirrups did not affect the deformation of the beam before cracking but increased the ductility of the beam.

## APPENDIX A CALCULATIONS OF PROPERTIES OF AREAS OF DIFFERENT SECTIONS

### Properties of Section Type One

$$A_c = (6.25 \times 12) + (5 \times 14.75) = 148.75 \text{ sq. in.}$$

$$y_b = \frac{\{(5 \times 14.75) (14.75/2) + (6.25 \times 12) (14.75 + 6.25/2)\}}{148.75} = 12.67''.$$

$$y_t = 21 - 12.67 = 8.33''$$

$$I = \frac{5(14.75)^3}{12} + (5 \times 14.75) (12.67 - 14.75/2)^2 + \frac{12(6.25)^3}{12} + (6.25 \times 12) (8.33 - 6.25/2)^2 = 5681 \text{ in}^4.$$

### Properties of Section Type Two

$$A_c = (6.25 \times 12) + (5 \times 15.25) = 151.25 \text{ sq. in.}$$

$$y_b = \frac{\{(5 \times 15.25) (15.25/2) + (6.25 \times 12) (15.25 + 6.25/2)\}}{151.25} = 12.95''.$$

$$y_t = 21 - 12.95 = 8.05''$$

$$I = \frac{5(15.25)^3}{12} + (5 \times 15.25) (12.95 - 15.25/2)^2 + \frac{12(6.25)^3}{12} + (6.25 \times 12) (8.05 - 6.25/2)^2 = 5703.17 \text{ in}^4.$$



**APPENDIX B**  
**CALCULATIONS OF ULTIMATE & CRACKING MOMENTS**  
**According to ACI-Code 318-89**

**Beam Type One**

$$A_{ps} = 3 (0.217) = 0.651 \text{ sq. in.}$$

$$d = 21 - 4.5 = 16.5''$$

$$b_f = 12'' \text{ \& } b_w = 5.0''$$

$$r_p = 0.651 / (12 \times 16.5) = 0.00329$$

$$f_{ps} = 270 \{ 1 - (0.28 / 0.7375) (0.00329) (270 / 6.25) \} = 255.4 \text{ ksi}$$

$$T = 0.651 (255.4) = 166.27 \text{ kips}$$

$$a = 166.27 / (0.85 \times 6.25 \times 12) = 2.61''$$

$$\omega_p = 0.00329 (255.4) / 6.25 = 0.134 < 0.36 \beta_1 = 0.265$$

$$\phi = 1.0$$

$$M_u = 166.27 (16.5 - 2.61 / 2) = 2526.5 \text{ kip-in.}$$

$$f_r = 7.5 (6250)^{0.5} = 593 \text{ psi}$$

$$r^2 = 5861 / 148.75 = 38.19 \text{ sq. in.}$$

$$K = 38.19 / 12.67 = 3.01 \text{ in.}$$

$$e = 12.67 - 4.5 = 8.17 \text{ in.}$$

$$f_{se} = 105 \text{ kips}$$

$$M_{cr} = 105 (8.17 + 3.01) + (593 \times 5681) / 12.67 \times 1000)$$

$$= 1439.8 \text{ kip-in.}$$

70

**Beam Type Two**

$$A_{ps} = 3 (0.217) = 0.651 \text{ sq. in.}$$

$$d = 21.5 - 4.75 = 16.75"$$

$$b_f = 12" \text{ \& } b_w = 5.0"$$

$$r_p = 0.651 / (12 \times 16.75) = 0.00324$$

$$f_{ps} = 270 \{ 1 - (0.28 / 0.7375) (0.00324) (270 / 6.25) \} = 255.65 \text{ ksi}$$

$$T = 0.651 (255.65) = 166.43 \text{ kips}$$

$$a = 166.27 / (0.85 \times 6.25 \times 12) = 2.61"$$

$$\omega_p = 0.00324 (255.65) / 6.25 = 0.132 < 0.36 \beta_1 = 0.265$$

$$\phi = 1.0$$

$$M_u = 166.43 (16.75 - 2.61 / 2) = 2570.5 \text{ kip-in.}$$

$$f_r = 7.5 (6250)^{0.5} = 593 \text{ psi}$$

$$r^2 = 5730 / 151.25 = 37.70 \text{ sq. in.}$$

$$K = 37.70 / 12.95 = 2.91 \text{ in.}$$

$$e = 12.95 - 4.75 = 8.20 \text{ in.}$$

$$f_{se} = 105 \text{ kips}$$

$$M_{cr} = 105 (8.20 + 2.91) + (593 \times 5681) / 12.95 \times 1000)$$

$$= 1427.7 \text{ kip-in.}$$

## APPENDIX C CALCULATION OF SHEAR FORCES AND SHEAR CAPACITIES

### SAMPLE CALCULATION (See Fig. C1)

#### Station One at $x = 1.0'$

$V_{cw}$  controls at this section.

$$f_{pc} = 105/148.75 = 0.705 \text{ ksi} = 705 \text{ psi}$$

$$V_{vp} = 0.0$$

$$d = 16.5''$$

$$0.8 h = 0.8 (21) = 6.8'' \text{ controls}$$

$$V_{cw} = [3.5(6250)0.5 + 0.3(7.05)] 5(16.8) + 0 = 41008 \text{ lbs.} - 41.0 \text{ kips}$$

#### Station Two at $x = 2.5'$

$$F_{se} = 105 \text{ kips}$$

$$F_{pc} = 105/148.75 + 105(8.17)0.5/5681 = 1.94 \text{ ksi} = 1940 \text{ psi}$$

$$M_d = 0.155(13)2.5/2 - 0.155(2.5)0.5/2 = 2.03 \text{ kip-ft.}; = 24.36 \text{ kip-in.}$$

$$F_d = 24.36(12.67)/5681 = 0.054 \text{ ksi} = 54 \text{ psi}$$

$$V_d = 0.155(6.2 - 2.5) = 0.62 \text{ kips}$$

$$M_{cr} = 5681 [(6) (6250)0.5 + 1940 - 54/12.67] \\ = 1058334.7 \text{ lb-in.}$$

$$V_u = 1.5(0.62) + 1.7(37.69) = 64.94 \text{ kips}$$

$$M_u = 1.4(24.36) + 1.7(37.69) (2.5 \times 12) = 1956.29 \text{ kip-in.}$$

$$V_i = 64.94 - 0.62 = 64.32 \text{ kips}$$

$$M_{max} = 1956.29 - 24.36 = 1932 \text{ kip-in.}$$



72

$$\begin{aligned} V_{ci} &= 0.6(6250)0.5(5 \times 16.8) + 620 + 64.32(1058334.7/1932) \\ &= 39898.5 \text{ lbs.} = 39.84 \text{ kips} \end{aligned}$$

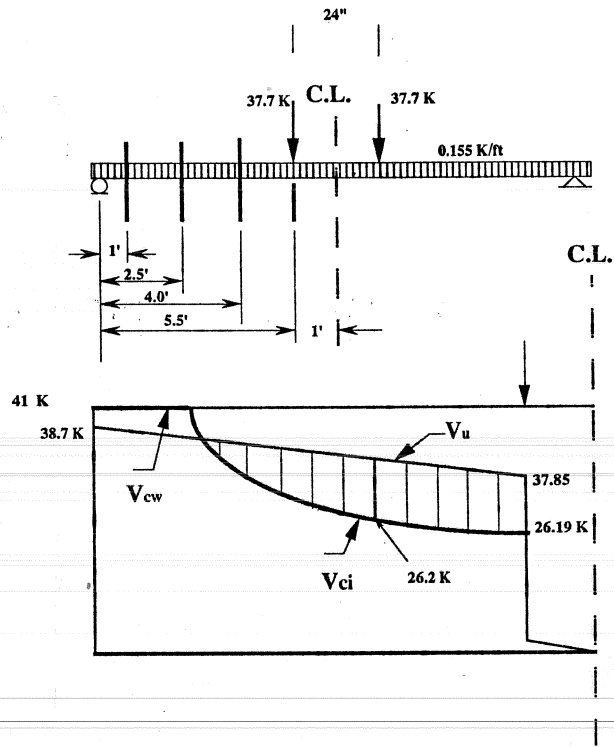

Figure C1. Ultimate shear force and concrete nominal shear strength (Beams R2 & R4).

## APPENDIX D CALCULATIONS OF HORIZONTAL SHEAR STRESSES

$$V_h = V_u Q / I b$$

$V_h$  = Shear stress at any given level

$Q$  = Statical moment of the cross-sectional area above (or below) that level about the centroidal axis

$b$  = width of the section at that level

$I$  = Second moment of inertia of cross section

### Type One Beams

$$I = 5681 \text{ in}^4$$

$$b = 5.0''$$

$$Q = (5 \times 9) (12.67 - 4.5) = 367.65 \text{ in}^3$$

$$V_h = V_u (367.65) / (5681 \times 5) = 0.012943 V_u$$

Table D1 Horizontal Shear Stress at Failure (Beams R1)			
Station #	Dist x from support	$V_f$ (kips)*	$V_h$ (psi)
1	1.0	47.8	618.7
2	2.5	47.7	616.7
3	3.5	47.3	616.7
4	4.5	47.1	609.7

\* Shear force at failure

Table D2 Horizontal Shear Stress at Failure (Beams R2)			
Station #	Dist x from support	$V_f$ (kips)*	$V_h$ (psi)
1	1.0	40.1	519.5
2	2.5	39.9	516.6
3	4.0	39.7	513.5
4	5.5	39.4	510.5

Table D3. Horizontal Shear Stress at Failure (Beams R4)			
Station #	Dist x from support	$V_f$ (kips)*	$V_h$ (psi)
1	1.0	34.4	444.7
2	2.5	34.1	441.6
3	4.0	33.9	439.2
4	5.5	33.7	435.7

### Type Two Beams

$$I = 5703.17 \text{ in}^4$$

$$b = 5.0''$$

$$Q = (5 \times 9.5) (12.95 - 4.75) = 389.5 \text{ in}^3$$

$$V_h = 0.013659 V_u$$

Table D4. Horizontal Shear Stress at Failure (Beams B1)			
Station #	Dist x from support	$V_f$ (kips)*	$V_h$ (psi)
1	1.0	27.04	369.3
2	2.5	26.8	366.6
3	4.0	26.6	362.7
4	5.5	26.3	359.2

Table D5. Horizontal Shear Stress at Failure (Beams R3)			
Station #	Dist x from support	$V_f$ (kips)*	$V_h$ (psi)
1	1.0	39.5	540.1
2	2.5	39.3	536.9
3	4.0	39.0	532.8
4	5.5	38.8	530.5



## APPENDIX E NOTATIONS

$a$	=	depth of compression zone
$A_c$	=	area of concrete section resisting shear transfer
$A_{ps}$	=	area of prestress reinforcement in tension zone
$b_f$	=	width of flange
$b_w$	=	width of web
$l_d$	=	development length
$d$	=	distance from extreme compression fiber to centroid of prestressed tension reinforcement
$d_b$	=	nominal diameter strand
$f_n$	=	stress in prestressed reinforcement at nominal strength
$f_r$	=	modulus of rupture
$f_{se}$	=	effective stress in prestressed reinforcement (after allowance for all prestress losses)
$F_{se}$	=	effective prestress force (after allowance for all prestress losses)
$f_x$	=	longitudinal normal stress
$I$	=	moment of inertia of gross concrete section
$K$	=	kern distance
$M_u$	=	ultimate flexural capacity of concrete section
$r$	=	radius of gyration
$T$	=	tensile force in prestressing strands

78

$v$  = shear stress

$V_h$  = horizontal shear stress

$V_f$  = shear force at failure

$y_b$  = distance from neutral axis to bottom fiber of concrete section

$y_t$  = distance from neutral axis to top fiber of concrete section

$\omega_p$  = reinforcement index

$\phi$  = strength reduction factor

## BIBLIOGRAPHY

1. Amirikian, A., "Split-Beam Prestressing," **The Navy Civil Engineer**, Vol. 4, No. 11, 1963, p. 35.
2. MacGregor, J.G., "Load and Resistance Factors for Concrete Design," **American Concrete Institute Journal, Proceedings**, Vol. 80, No. 4, July-August 1983, pp. 279-287.
3. "Short Course on Investigation of Structural Failure, Course Content Notes." Notes prepared for ASCE, Wiss, Janney, Elstner and Associates, Inc., Northbrook, May 1976.
4. American Concrete Institute, "Building Code Requirements for Reinforced Concrete," **ACI 318-89 and Commentary - ACI318R-89**, Detroit.
5. Hanson, N., "Precast - Prestressed Concrete Bridges, 2. Horizontal Shear Connection," **Journal of the PCA Research and Development Laboratories**, Vol. 2, No. 2, 1960, pp. 38-58.
6. Evans, R.H., and Parker, A.S., "Behavior of Prestressed Concrete Composite Beams," **ACI Journal, Proceedings**, Vol. 51, May 1955, pp. 861-878.
7. Bryson, J.O., Skoda, L.F., and Watstein, D., "Flexural Behavior of Prestressed Split Beam Composite Concrete Sections," **PCI Journal**, Vol. 10, No. 2, June 1965, pp. 77-91.
8. Veeraiyah, C., "Dynamic Behavior and Resistance of Prestressed Concrete Split Beams," Ph.D. Dissertation supervised by Dr. N.H. Burns, The University of Texas at Austin, Texas, 1972.
9. Elstner, R.C., and Hognestad, E., "Laboratory Investigation of Rigid Frame Failure," **ACI Journal**, Vol. 53, January 1957, pp. 637-668.
10. Anderson, Boyd G., "Rigid Frame Failure," **ACI Journal, Proceedings**, Vol. 53, January 1957, pp. 625-636.
11. Bruce, R.N., "The Action of Vertical, Inclined and Prestressed Stirrups in Prestressed Concrete Beams," **PCI Journal**, Vol. 9, No. 1, February 1964, pp. 14-25.



12. Collins, F., and Roper, H., "Laboratory Investigation of Shear Repair of Reinforced Concrete Beams Loaded in Flexure," **ACI Materials Journal**, March-April 1990, Vol. 87, No. 2, pp. 149-159.
13. MacGregor, J.G., **Reinforced Concrete, Mechanics and Design**, Prentice Hall, 1988.
14. Lin, T.Y., and Burns, N.H., **Design of Prestressed Concrete Structures**, Third Edition, John Wiley and Sons, 1981.
15. Hurst, M.K., **Prestressed Concrete Design**, Chapman and Hall, 1988, pp. 34-47.
16. Billet, D.F., and Appleton, J.H., "Flexural Strength of Prestressed Concrete Beams," **ACI Journal**, June 1954, pp. 837-854.
17. Zwoyer, E.M. and Siess, C.P., "Ultimate Strength in Shear of Simply-Supported Prestressed Concrete Beams Without Web Reinforcement," **ACI Journal**, Vol. 50, October 1954, pp. 181-200.
18. MacGregor, J.G., Sozen, M.A., and Siess, C.P., "Strength of Prestressed Concrete Beams with Web Reinforcement," **ACI Journal**, Vol. 62-83, December 1965, pp. 1503-1519.
19. Sozen, M.A., "Research on Shear Strength of Prestressed Beams," **PCI Journal**, Vol. 5, No. 2, June 1960, pp. 40-49.
20. Zekaria, I., "Shear Failure of Two-Span Continuous Prestressed Concrete Beams Without Web Reinforcement," **PCI Journal**, Vol. 3, No. 1, June 1958, pp. 10-53.
21. Bobrowski, J. and Bardhan-Roy, B.K., "A Method of Calculating the Ultimate Strength of Reinforced and Prestressed Concrete Beams in Combined Flexure and Shear," **The Structural Engineer**, Vol. 47, No. 5, May 1969, pp. 197-209.
22. Hanson, N.W., and Kaar, P.H., "Flexural Bond Tests of Pretensioned Prestressed Beams," **ACI Journal**, Vol. 55-51, January 1959, pp. 783-802.
23. Zia, P. and Mostafa, T., "Development Length of Prestressing Strands," **PCI Journal**, Vol. 22, No. 5, September-October 1977, pp. 54-65.
24. ACI Committee 224, "Causes, Evaluation and Repair of Cracks in Concrete Structures," (ACI 224.1R-84), **American Concrete Institute**, Detroit, 1984.

25. Chung, H.W., and Lui, L.M., "Epoxy-Repaired Concrete Joints," **ACI Journal, Proceedings**, Vol. 74, No. 6, June 1977, pp. 264-267.
26. Hewlett, P.C. and Morgan, J.G.D., "Static and Cyclic Response of Reinforced Concrete Beams Repaired by Resin Injection," **Magazine of Concrete Research** (London), Vol. 34, No. 118, March 1982, pp. 5-17.
27. Brondum-Nielsen, Troels, "Epoxy Resin Repair of Cracked Concrete Beams," **Report No. R89, Structural Research Laboratory**, Technical University of Denmark, Lyngby, 1978.
28. Stratton, F. Wayne, Alexander, Roger B., and Nolting, William J., "Repair of Cracked Structural Concrete by Epoxy Injection and Rebar Insertion," **Transportation Research Record No. 676**, Transportation Research Board, 1978, pp. 34-36.
29. Hewlett, P.C., and Shaw J.D.N., "Structural Adhesives Used in Civil Engineering," **Developments in Adhesives - 1**, Applied Science Publishers, London, 1977, pp. 55-59.
30. Irwin, C.A.K., "Strengthening of Concrete Beams by Bonded Steel Plates," **TRRL Supplementary Report No. 160**, Transport and Road Research Laboratory, Crowthorne, Berkshire, 1975.
31. Madeley, T.D., "Epoxy-Bonded External Reinforcement for Concrete Members in Direct Shear and Flexure," M.S. Thesis, University of Texas at Austin, December 1987.
32. "Engineered Repair of Concrete Structures," Seminar, The University of Sydney Civil and Mining Engineering Foundation/Concrete Institute of Australia, North Sydney, 1985, pp. 5.14-5.15.
33. Warner, R.F., "Strengthening, Stiffening and Repair of Concrete Structures," **IABSE Periodical No. 5-17/18**, International Association of Bridge and Structural Engineering, Zürich, May 1981, pp. 25-43.
34. Sommerard, T., "Swanley's Steel Plate Patch-Up," **New Civil Engineer** (London), June 16, 1977, pp. 18-19.
35. Johnson, S.M., "**Deterioration, Maintenance and Repair of Structures**," McGraw Hill Book Company, 1965, pp. 341-343.

36. Vernigora, E., Marcil, J.R.M., Slater, W.M., and Aiken, R.V., "Bridge Rehabilitation and Strengthening by Continuous Post-Tensioning," **PCI Journal**, Vol. 14, No. 2, April 1969, pp. 88-104.
37. Berridge, P.S.A., and Lee, D.H., "Prestressing Restores Weakened Truss Bridge," **Civil Engineering**, September 1956, pp. 48-49.
38. Rabbat, B.G., Kaar, P.H., Russell, H.G., and Bruce, R.N., Jr., "Fatigue Tests of Pretensioned Girders with Blanketed and Draped Strands," **PCI Journal**, Vol. 24, No. 4, July-August 1979, pp. 88-114.
39. Martin, L.D., and Scott, N.L., "Development of Prestressing Strand in Pretensioned Member," **ACI Journal, Proceedings**, Vol. 73, No. 8, August 1976, pp. 453-456.
40. Anderson, A.R., and Anderson, R.G., "An Assurance Criterion for Flexural Bond in Pretensioned Hollow Core Units," **ACI Journal**, August 1976, Vol. 73, No. 37, pp. 457-464.
41. Guyon, Y., "**Limit State Design of Prestressed Concrete**," Vol. 2, John Wiley and Sons, pp. 39-151.