

**ADHESIVE ANCHORS:  
BEHAVIOR AND SPACING REQUIREMENTS**

by

**G. T. DOERR AND R. E. KLINGNER**

**Research Report No. 1126-2  
Research Project 3-5-86-1126  
"Design Guide for Short Anchor Bolts"**

**Conducted for  
Texas  
State Department of Highways and Public Transportation  
In Cooperation with the  
U.S. Department of Transportation  
Federal Highway Administration**

by

**CENTER FOR TRANSPORTATION RESEARCH  
BUREAU OF ENGINEERING RESEARCH  
THE UNIVERSITY OF TEXAS AT AUSTIN**

**March 1989**

<b>1. Report No.</b> FHWA/TX-89+1126-2	<b>2. Government Accession No.</b>	<b>3. Recipient's Catalog No.</b>	
<b>4. Title and Subtitle</b> ADHESIVE ANCHORS: BEHAVIOR AND SPACING REQUIREMENTS		<b>5. Report Date</b> March 1989	<b>6. Performing Organization Code</b>
<b>7. Author(s)</b> G. T. Doerr and R. E. Klingner		<b>8. Performing Organization Report No.</b> Research Report 1126-2	
<b>9. Performing Organization Name and Address</b> Center for Transportation Research The University of Texas at Austin Austin, Texas 78712-1075		<b>10. Work Unit No.</b>	<b>11. Contract or Grant No.</b> Research Study 3-5-86-1126
<b>12. Sponsoring Agency Name and Address</b> Texas State Department of Highways and Public Transportation; Transportation Planning Division P. O. Box 5051 Austin, Texas 78763-5051		<b>13. Type of Report and Period Covered</b> Interim	
<b>14. Sponsoring Agency Code</b>			
<b>15. Supplementary Notes</b> Study conducted in cooperation with the U. S. Department of Transportation, Federal Highway Administration Research Study Title: "Design Guide for Short Anchor Bolts"			
<b>16. Abstract</b>  <p>The purpose of this study was to investigate the behavior of retrofit adhesive anchors in concrete, and to develop a rational design procedure for these anchors. The study involved 105 tensile tests on the following types of 5/8-inch adhesive anchors: fully bonded single anchors; partially bonded single anchors (debonded over their upper 2 inches); fully bonded anchor pairs; and other miscellaneous tests.</p> <p>Fully bonded single anchors failed by fracture of the anchor steel, or by formation of a shallow concrete cone (with an average depth between 1 and 2 inches), accompanied by pullout of the adhesive. Partially bonded single anchors either by fracture of the anchor steel, or by pullout of an adhesive core, without cone formation. Fully bonded paired anchors failed similarly to fully bonded single anchors. At close spacings, the concrete cones may overlap, producing a unified concrete cone for the anchor pair.</p> <p>Fully bonded adhesive anchors not exhibiting steel failure formed a concrete cone with an average depth between 1 and 2 inches. When the upper 2 inches of embedment were debonded, the concrete cone did not form, and failure was by bond. The capacity of a partially bonded anchors is approximately that of a fully bonded anchor in a hole of the same depth. The bond stress distribution for an adhesive anchor can be found using an elastic solution. The maximum bond stress can be found by tests on partially bonded anchors.</p> <p>Reductions in the capacity of closely spaced anchors are linked to the formation of overlapping concrete cones. Because fully bonded adhesive anchors form a cone with an average depth of 1 to 2 inches, anchors must be within about 4 inches of one another to have overlapping cones. Close spacing has little effect on the capacity of fully bonded adhesive anchors is minimal. For the anchors tested, spacings as small as 4 inches produced ultimate loads averaging 95% as high as those expected for two single anchors.</p> <p>Detailed design recommendations for adhesive anchors can be found in the Design Guide produced as Report 1126-4F of this project. All anchors should be designed using a capacity equation based on the behavior of partially bonded anchors, because this case is simpler than the fully bonded anchor and yields conservative results. A reduction in nominal capacity is recommended for both fully and partially bonded anchors spaced closer than 8 inches.</p>			
<b>17. Key Words</b> anchors, concrete, design procedure, retrofit, adhesive, fully bonded, partially bonded, failure, steel, cone, capacity, single, pairs		<b>18. Distribution Statement</b> No restrictions. This document is available to the public through the National Technical Information Service, Springfield, Virginia 22161.	
<b>19. Security Classif. (of this report)</b> Unclassified	<b>20. Security Classif. (of this page)</b> Unclassified	<b>21. No. of Pages</b> 86	<b>22. Price</b>

The contents of this report reflect the views of the authors, who are responsible for the facts and accuracy of the data presented herein. The contents do not necessarily reflect the official views or policies of the Federal Highway Administration. This report does not constitute a standard, specification, or regulation.

## PREFACE

Many structural details in current use by the Texas State Department of Highways and Public Transportation (SDHPT) involve the use of anchor bolts, sometimes in retrofit applications. Examples are attachment of traffic barriers to structures, attachment of bridge girders to bearing blocks, attachment of end fixtures to precast concrete components, and attachment of steel members to existing concrete. Anchors are of different types: cast-in-place, grouted, adhesive, expansion, or undercut. These anchors are now designed using procedures which are outdated and often erroneous. Recent investigations have suggested that various Texas SDHPT designs involving anchor bolts are inconsistent and possibly unconservative.

In developing more rational design procedures for such connections, it was necessary to study the basic behavior and spacing requirements of adhesive anchors. This report describes such a study. Based on the results of this study, recommendations are given for the design, qualification and testing of adhesive anchors in concrete.



## SUMMARY

The purpose of this study was to investigate the behavior of retrofit adhesive anchors in concrete, and to develop a rational design procedure for these anchors. The study involved 105 tensile tests on the following types of 5/8-inch adhesive anchors:

- 1) Fully bonded single anchors with embedment depths of 4 and 6 inches (26 tests)
- 2) Partially bonded single anchors with embedment depths of 4, 6, and 8 inches (36 tests). These anchors were debonded over their upper 2 inches.
- 3) Fully bonded anchor pairs spaced at 4, 6, and 8 inches (36 tests)
- 4) Miscellaneous tests to supplement a previous study conducted by Collins [1] (see Appendix C)

Fully bonded single anchors failed by fracture of the anchor steel, or by formation of a shallow concrete cone (with an average depth between 1 and 2 inches), accompanied by pullout of the adhesive. Partially bonded single anchors either by fracture of the anchor steel, or by pullout of an adhesive core, without cone formation. Fully bonded paired anchors failed similarly to fully bonded single anchors. At close spacings, the concrete cones overlapped, producing a unified concrete cone for the anchor pair.

Based on the test results reported here and elsewhere the following conclusions have been drawn regarding adhesive anchor behavior:

- 1) Fully bonded adhesive anchors not exhibiting steel failure form a concrete cone with an average depth between 1 and 2 inches. If the top 2 inches of embedment are debonded, the concrete cone does not form, and failure is by bond.
- 2) The capacity of a partially bonded anchor is approximately equal to that of a fully bonded anchor in a hole of the same depth.
- 3) The bond stress distribution for an adhesive anchor can be found using an elastic solution.

- 4) The maximum bond stress can be found by tests on partially bonded anchors.

Based on test results reported herein, the following conclusions have been drawn regarding the effects of close spacing on adhesive anchors:

- 1) Reductions in the capacity of closely spaced anchors are linked to the formation of overlapping concrete cones.
- 2) Because fully bonded adhesive anchors form a cone with an average depth of 1 to 2 inches, anchors must be within about 4 inches of one another to have overlapping cones.
- 3) Close spacing has little effect on the capacity of fully bonded adhesive anchors is minimal. For the anchors tested, spacings as small as 4 inches produced ultimate loads averaging 95% as high as those expected for two single anchors.

Detailed design recommendations can be found in the **Design Guide** produced as **Report 1126-4F** of this project. All anchors should be designed using a capacity equation based on the behavior of partially bonded anchors, because this case is simpler than the fully bonded anchor and yields conservative results. A reduction in nominal capacity is recommended for both fully and partially bonded anchors spaced closer than 8 inches.

## IMPLEMENTATION

This report is concerns a study of the behavior and design of adhesive anchors to concrete. The results of this report have already been incorporated into the draft of Research Report 1126-4F (**Design Guide**). That **Design Guide** should be used by the Texas SDHPT for design, qualification, and evaluation of connections involving short anchor bolts.





## TABLE OF CONTENTS

CHAPTER 1. INTRODUCTION . . . . .	1
1.1 General . . . . .	1
1.2 Scope and Objectives . . . . .	1
CHAPTER 2. BACKGROUND . . . . .	3
2.1 Introduction . . . . .	3
2.2 Current Knowledge of Adhesive Anchor Behavior . . . . .	3
2.3 Current Design Procedures for Adhesive Anchors . . . . .	7
CHAPTER 3. EXPERIMENTAL PROGRAM . . . . .	9
3.1 Test Matrix . . . . .	9
3.1.1 Test Phases . . . . .	9
3.1.2 Test Designations . . . . .	9
3.2 Test Specimens . . . . .	9
3.2.1 Development and Description of Test Specimens . . . . .	9
3.2.2 Construction of Test Specimens . . . . .	10
3.3 Anchor Installation Procedures . . . . .	11
3.3.1 Anchor Preparation . . . . .	11
3.3.2 Hole Preparation . . . . .	11
3.3.3 Preparation of Adhesives . . . . .	14
3.3.4 Placement of Anchors . . . . .	15
3.3.5 Curing . . . . .	16
3.4 Testing Apparatus and Procedure . . . . .	16
3.4.1 Loading System . . . . .	16
3.4.2 Instrumentation . . . . .	17
3.4.3 Test Procedure . . . . .	17

CHAPTER 4. TENSILE BEHAVIOR OF SINGLE ANCHORS . . . . .	21
4.1 General . . . . .	21
4.2 Tensile Behavior of Fully Bonded Single Anchors . . . . .	21
4.2.1 Failure by Concrete Cone with Adhesive Core . . . . .	21
4.2.2 Failure by Yield and Fracture of Anchor Steel . . . . .	21
4.3 Tensile Behavior of Partially Bonded Single Anchors . . . . .	22
4.3.1 Failure by Pullout of Adhesive Core . . . . .	22
4.3.2 Failure by Yield and Fracture of Anchor Steel . . . . .	22
CHAPTER 5. BEHAVIORAL MODELS FOR SINGLE ADHESIVE ANCHORS . . . . .	25
5.1 General . . . . .	25
5.2 Elastic Model for Bond Stress Distribution . . . . .	25
5.2.1 Development of Mathematical Model . . . . .	25
5.2.2 Application of Elastic Model to Partially Bonded Anchors . . . . .	29
5.2.3 Correlation of Elastic Theory with Test Data . . . . .	29
5.3 Application of Elastic Model to Fully Bonded Adhesive Anchors . . . . .	34
5.3.1 General . . . . .	34
5.3.2 Stages of Behavior . . . . .	34
5.4 Discussion of Elastic Model . . . . .	38
5.4.1 Advantages of Elastic Theory . . . . .	38
5.4.2 Disadvantages of Elastic Theory . . . . .	38
5.4.3 Resolution . . . . .	38
5.4.4 Conclusions Regarding Use of Elastic Theory . . . . .	38

CHAPTER 6. TENSILE BEHAVIOR OF FULLY BONDED PAIRED ANCHORS AT VARIOUS SPACINGS . . . . .	45
6.1 General . . . . .	45
6.2 Failure by Concrete Cones with Adhesive Cores . . . . .	45
6.3 Failure by Yield and Fracture of Anchor Steel . . . . .	47
6.4 Discussion of Results of Paired Anchor Tests . . . . .	48
CHAPTER 7. DESIGN RECOMMENDATIONS FOR ADHESIVE ANCHORS . . . . .	51
7.1 Capacities of Single Adhesive Anchors . . . . .	51
7.2 Design of Single Adhesive Anchors . . . . .	51
7.3 Design of Grouped Adhesive Anchors . . . . .	53
CHAPTER 8. SUMMARY, CONCLUSIONS, AND RECOMMENDATIONS . . . . .	55
8.1 Summary . . . . .	55
8.2 Conclusions . . . . .	56
8.2.1 Behavioral Model . . . . .	56
8.2.2 Spacing Effects . . . . .	57
8.3 Recommendations for Design . . . . .	57
8.4 Recommendations for Further Research . . . . .	58
APPENDIX A: COMPLETE TEST RESULTS FOR SINGLE ANCHORS	59
APPENDIX B: COMPLETE TEST RESULTS FOR PAIRED ANCHORS	63
APPENDIX C: COMPLETE TEST RESULTS FOR SUPPLEMENT TO COLLINS TEST . . . . .	65
REFERENCES . . . . .	67



## LIST OF TABLES

<u>Table</u>		<u>Page</u>
3.1	Test Matrix . . . . .	10
3.2	Cylinder Strengths . . . . .	12
5.1	Actual vs. Computed Capacity for Fully Bonded Adhesive Anchors .	39
6.1	Results of Tests on Paired Adhesive Anchors . . . . .	49



## LIST OF FIGURES

<u>Figure</u>		<u>Page</u>
2.1	Steel Failure of Adhesive Anchor . . . . .	5
2.2	Cone Failure of Concrete . . . . .	5
2.3	Pullout Failure of Adhesive Anchor . . . . .	5
2.4	Progressive Cone Failure Theory . . . . .	6
3.1	Test Designations . . . . .	11
3.2	Rotary Hammer Drill . . . . .	13
3.3	Cleaning Holes with Stiff Brush . . . . .	13
3.4	“Gun” Type Adhesive Applicator . . . . .	14
3.5	Example of Glass Capsule for Polyester Resin . . . . .	15
3.6	Loading System . . . . .	17
3.7	Schematic Drawing of Loading System, Single Anchor Tests . .	18
3.8	Schematic Drawing of Loading System, Paired Anchor Tests . .	18
3.9	Load Shoe for Paired Anchor Tests . . . . .	19
4.1	Concrete Cone with Adhesive, Core Failure Mode . . . . .	22
4.2a	Initial Configuration . . . . .	23
4.2b	Adhesive Core Failure Mode . . . . .	23
5.1	Model of Adhesive Anchor System for Elastic Analysis . . . . .	25
5.2	Shearing Stiffness of Adhesive . . . . .	27
5.3a	Load vs. Embedment Curve for Partially Bonded Anchors, Adhesive A1 . . . . .	31
5.3b	Load vs. Embedment Curve for Partially Bonded Anchors, Adhesive A2 . . . . .	31



5.3c	Load vs. Embedment Curve for Partially Bonded Anchors, Adhesive A3 . . . . .	32
5.3d	Load vs. Embedment Curve for Partially Bonded Anchors, Adhesive A4 . . . . .	32
5.3e	Load vs. Embedment Curve for Partially Bonded Anchors, Adhesive A5 . . . . .	33
5.3f	Load vs. Embedment Curve for Partially Bonded Anchors, Adhesive A6 . . . . .	33
5.4	Partially Bonded Anchor, Case 1 . . . . .	34
5.5a	Actual Shape of Concrete Cone . . . . .	35
5.5b	Fully Bonded Anchor as Concrete Cone, Begins to Form, Case 2 . . . . .	35
5.6	After Concrete Cone has Formed, Case 3 . . . . .	37
5.7a	Capacities of Fully Bonded vs. Partially Bonded Anchors, Adhesive A1 . . . . .	41
5.7b	Capacities of Fully Bonded vs. Partially Bonded Anchors, Adhesive A2 . . . . .	41
5.7c	Capacities of Fully Bonded vs. Partially Bonded Anchors, Adhesive A3 . . . . .	42
5.7d	Capacities of Fully Bonded vs. Partially Bonded Anchors, Adhesive A4 . . . . .	42
5.7e	Capacities of Fully Bonded vs. Partially Bonded Anchors, Adhesive A5 . . . . .	43

5.7f	Capacities of Fully Bonded vs. Partially Bonded Anchors, Adhesive A6 . . . . .	43
6.1	Concrete Cones with Adhesive Cores, Failure Mode . . . . .	45
6.2	Effect of Anchor Spacing on Cone Radius . . . . .	46
6.3	Effect of Anchor Spacing on Cone Depths . . . . .	46
6.4	Capacity per Anchor vs. Anchor Spacing . . . . .	47



## CHAPTER 1. INTRODUCTION

### 1.1 General

The Texas State Department of Highways and Public Transportation currently uses anchor bolts in many structural applications, including attachment of traffic barriers to structures, steel elements to concrete, and bridge girders to bearing blocks. The anchor bolts used are either cast in place, grouted, adhesive, expansion or undercut anchors. These attachments are sometimes designed using procedures which are not substantiated by test results.

### 1.2 Scope and Objectives

Inadequacies of some current design procedures have prompted Texas SDHPT Project 1126, "Design Guide for Short Anchor Bolts." The purpose of the project is to improve current design procedures for cast-in-place anchor bolts, and to develop rational design procedures for retrofit anchor bolts. The final product of this research will be a design guide for use by the Texas SDHPT.

**Project 1126** comprises the following four phases:

- Phase 1.** Behavior of single cast-in-place, adhesive, expansion, and undercut anchors under static, impact, and fatigue loadings.
- Phase 2.** Behavior of baseplates with groups of cast-in-place, adhesive, expansion, and undercut anchors under combined shear and moment.
- Phase 3.** Behavior of individual and paired adhesive anchors in tension.
- Phase 4.** Development of a design guide for single anchors, group anchors, and baseplate situations.

Work concluded in **Phase 3** is described herein, and had the following objectives:

- 1) To develop a model for bond between adhesive anchors and surrounding concrete.
- 2) To develop a behavior model for adhesive anchors.

- 3) To determine the effects of close spacing of multiple adhesive anchors.
- 4) This work is not directly related to the other three objectives, and is not discussed further in the body of this report. It is discussed in Appendix C of this report.

## CHAPTER 2. BACKGROUND

### 2.1 Introduction

Anchor bolts can be divided into two general categories: cast in place and retrofit. During recent years much has been learned about cast in place anchors. The growth of the nuclear industry in past years led to increased research on these anchors, and led to the development of ACI 349 Appendix B, a design guide for short headed anchors [2].

While retrofit anchors are less well understood than cast-in-place ones, they are preferable in some situations and the only choice in others. Use of retrofit anchors allows greater flexibility in attachment of objects to concrete. One major obstacle to understanding the behavior of retrofit anchors is the large variety of anchors. Research is complicated by the multitude of brands and types of retrofit anchors. Existing design codes give little or no assistance for the design of retrofit anchors.

### 2.2 Current Knowledge of Adhesive Anchor Behavior

Adhesive anchors generally behave like grouted anchors. The anchoring material is an adhesive usually consisting of epoxy, polyester, or vinylester resins.

Epoxy adhesives are synthetic compounds consisting of an epoxy resin combined with a curing agent. The epoxy resin is designated as component "A," and the curing agent, as component "B." Epoxy adhesives require heat to cure. This heat is generated by the exothermic reaction which occurs when the epoxy resin and the curing agent are combined. Advantages associated with epoxy resins include durability, long shelf life, crack resistance, and low shrinkage during curing.

Polyester adhesives are thermosetting plastics consisting of a polyester resin and a catalyst. Polyester resins tend to have a shorter curing time than epoxy adhesives. Limitations associated with polyester adhesives include short shelf life, tendency to degrade under ultraviolet light, and tendency to polymerize without the addition of a catalyst at high temperatures [17].

Vinylester adhesives are thermosetting plastics consisting of a vinylester resin and a catalyst. Vinylester resins tend to be more flexible than polyester resins. Limitations associated with vinylester resins include short shelf life, tendency to degrade under ultraviolet light, and tendency to polymerize without the addition of a catalyst at high temperatures.

Adhesive anchors transfer load differently than do headed cast-in-place or mechanical anchors. Headed anchors transfer load through bearing of the anchor head on the concrete. Adhesive anchors transfer load through adhesion to the concrete along the entire bonded portion of the anchor. Factors affecting this load transfer include the bond between adhesive and steel, and between the adhesive and concrete. Bond between the adhesive and the concrete is heavily influenced by the extent to which the adhesive impregnates the concrete surrounding the drilled hole. Proper hole preparation can assure maximum penetration of adhesive into the concrete [15]. Concrete dust left on the inside of the hole can create a poor bond to the concrete.

Adhesive anchors display three types of failure modes (Figs. 2.1, 2.2, and 2.3):

- 1) Fracture of anchor steel
- 2) Cone failure of concrete, usually with an adhesive core
- 3) Pullout of an adhesive core

Fracture of the anchor steel is likely to occur only with sufficiently long embedment depths, and the load depends on the tensile strength of the anchor.

It has been suggested by Daws [10] that a concrete cone can form without the presence of an adhesive core. Daws suggests (Fig. 2.4) that the cone fails by progressive formation of conical failure cracks farther and farther from the concrete surface. Testing conducted in all phases of this project showed no evidence to support this theory.

Other theories address the effect of the adhesive bond, combined with that of the concrete cone. Such combined failure mechanisms are strongly influenced by the distribution of bond stress along the anchor. Both linear and nonlinear bond

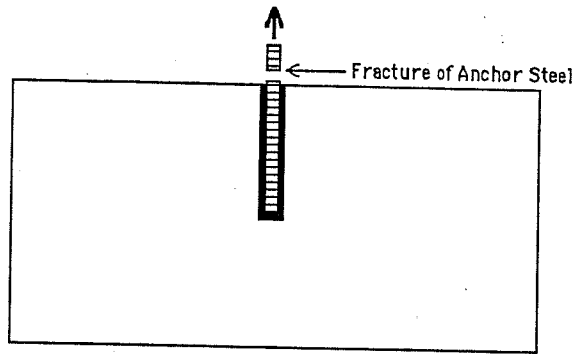

Fig. 2.1 Steel Failure of Adhesive Anchor

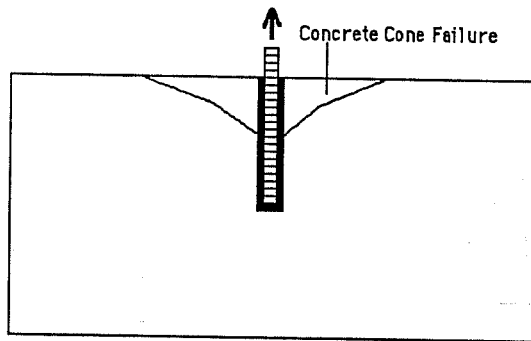

Fig. 2.2 Cone Failure of Concrete

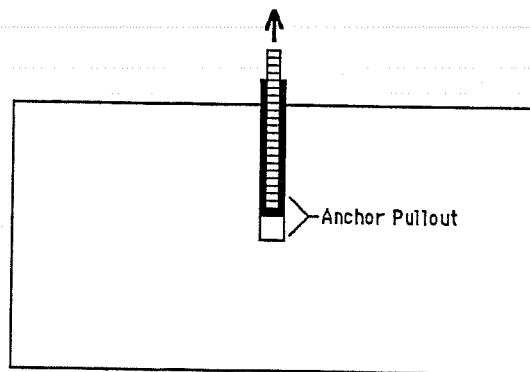

Fig. 2.3 Pullout Failure of Adhesive Anchor



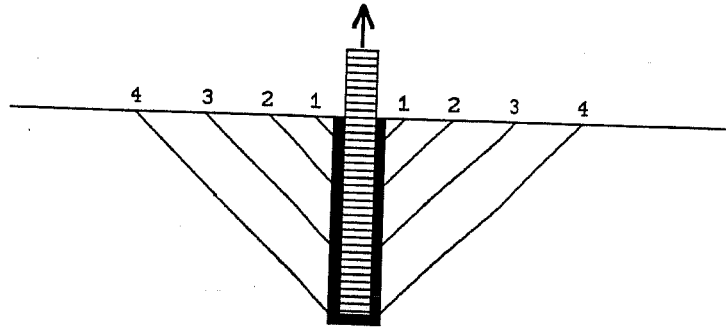

Fig. 2.4 Progressive Cone Failure Theory

stress distributions have been suggested [1]. One of the principal objectives of this study is to gain a better understanding of bond stress distribution.

As stated earlier, the load transfer of the adhesive depends on the bond between adhesive and concrete, and between the adhesive and steel. Along both interfaces, bond depends both on chemical bond, and on mechanical interlock. Failure along either interface can cause anchor pullout. Chemical bond failure may occur if the adhesive is improperly cured, or if the adhesive lacks adequate bond strength characteristics. Mechanical interlock failure may occur when the anchor is improperly cleaned or when the hole is improperly prepared.

Pullout of an adhesive core can also occur when the top portion of the embedment length is debonded. Debonding lowers the point of load transfer so that a concrete cone is prevented from forming. Anchor behavior is then dependent only on the adhesive bond and the properties of the steel.

### **2.3 Current Design Procedures for Adhesive Anchors**

No specific design codes are available in the U.S. for adhesive anchors. Currently, most designers follow manufacturers' recommendations, which are usually based on average strengths determined in laboratory tests [12, 18]. Required embedments based on these average strengths are then increased by a factor of safety between 3 and 4. The purpose of this study is to assess the behavior of adhesive anchors so that rational design procedures can be developed.



## CHAPTER 3. EXPERIMENTAL PROGRAM

### 3.1 Test Matrix

*3.1.1 Test Phases.* Three phases of tests were conducted on the following types of specimens:

- 1) Fully bonded single anchors with varying embedment depths
- 2) Partially bonded single anchors with varying embedment depths
- 3) Fully bonded paired anchors with varying spacings

For all phases, the anchors used were 5/8-inch diameter threaded rod, made of high-strength steel meeting ASTM A193-B7. In each phase, six different adhesives were used. The complete test matrix is summarized in Table 3.1. Test designations are outlined in Section 3.1.2.

In Phase 1, the embedment depths for the anchors were either 4 inches or 6 inches. In Phase 2, the embedment depths were 4 inches, 6 inches or 8 inches. In Phase 3, all embedment depths were 8 inches. In Phase 3, the paired anchors were spaced at 4 inches, 6 inches, or 8 inches.

*3.1.2 Test Designations.* Each test was identified with a set of 5 characters, as shown in Fig. 3.1. The first two characters designate the adhesive. The next letter designates the test phase. The next number designates the length of embedment for Phases 1 and 2 and the spacing for Phase 3. The final number is the replicate number.

### 3.2 Test Specimens

*3.2.1 Development and Description of Test Specimens.* The test specimens consisted of anchors placed in a concrete block measuring 24 x 40 x 56 inches. Several anchors were placed in each block. The concrete blocks were cast with Texas SDHPT Class C concrete. The minimum design compressive strength was 3600 psi

---



---

**TABLE 3.1**  
**TEST MATRIX**

Test Designation	Adhesive					
	A1	A2	A3	A4	A5	A6
E4	2	2	2	2	2	2
E6	2	2	2	2	2	2
B4	2	2	2	2	2	2
B6	2	2	2	2	2	2
B8	2	2	2	2	2	2
S4	2	2	2	2	2	2
S6	2	2	2	2	2	2
S8	2	2	2	2	2	2

Adhesives

A1 - Ramset ITW Epcon System

A2 - Hilti HIT C100 System

A3 - Hilti HVA Glass Capsule

A4 - Kelken Gold KeliGrout System

A5 - Sika Sikagel

A6 - Sika Sika Injection System

---



---

at 28 days. Compression tests were performed on cylinders made during each cast. All cylinder strengths exceeded the required minimum strength (Table 3.2).

The blocks were designed so that the top, bottom, and one side could all be used for placement of anchors. The blocks were also used in Phase 2 of the project (Section 1.2). The reinforcing steel in the blocks consisted of seven #6 bars on top and bottom with twelve #4 U-stirrups. This reinforcement was to prevent cracking of the blocks during handling. It did not influence the behavior of the anchors.

**3.2.2 Construction of Test Specimens.** Three sets of forms were constructed so that three blocks could be cast during each pour. All specimens were

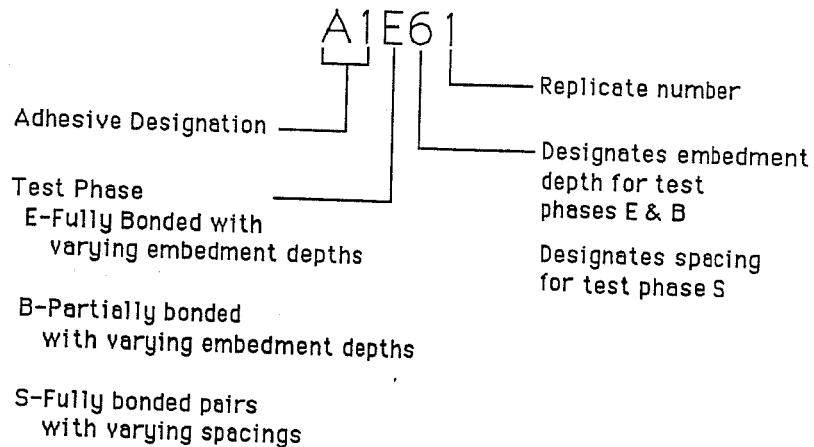

Fig. 3.1 Test Designations

cast outdoors using ready-mix concrete, consolidated with a mechanical vibrator, then screened and troweled to a smooth finish. Cylinders were cured beside the specimens under the same conditions as the specimens. The formwork was usually stripped 24 hours after casting. Specimens were tested at ages between 28 and 155 days.

### 3.3 Anchor Installation Procedures

**3.3.1 Anchor Preparation.** All anchors were made of 5/8-inch threaded rod meeting ASTM A193-B7. These threaded rods were cut to the desired length, wire-brushed, and immersed in a solvent, usually methyl-ethyl-ketone. The rods were then wiped clean to remove any residue.

**3.3.2 Hole Preparation.** Unless otherwise specified by the manufacturers, all holes were drilled with a 3/4-inch bit. This hole diameter adheres to recommendations by several manufacturers that the optimum hole diameter should be only 1/8 inch larger than the anchor diameter. A rotary hammer drill (Fig. 3.2) was used

**TABLE 3.2**  
**CYLINDER STRENGTHS**

Pour #	Compressive Strength (28 days) psi	Compressive Strength (at Testing) psi
1	4500	05750-6500
2	5000	5500-6500
3	4000	4500-6500
4	6000	6000-6500
5	5500	6500-6750
6	6000	6250-6750
7	4500	4750
8	4500	4500
9	4500	5500

to drill all holes. Hole depths were measured with a tape measure after the holes were cleaned.

All holes were cleaned (Fig. 3.3) using a stiff brush and a vacuum cleaner. This procedure follows recommendations from previous research [1]. The walls of the holes were brushed using a stiff bottle brush to loosen as much dust as possible. The holes were then vacuumed using an industrial vacuum cleaner. A long, 1/4-inch diameter nozzle was used to remove dust from the sides and bottom of hole. This procedure was continued until a gloved finger rubbed on the walls came out dust-free.

For the partially bonded anchor tests, the top 2 inches of the hole and anchor were treated with a debonding agent, in most cases a viscous silicone sealant. For the glass capsule adhesive, a different approach was used, because the glass shredded the silicone during the placement process. The top two inches of the hole were redrilled with a larger diameter drill bit. The inside of this portion of the hole was then coated with silicone. A piece of 2 inch wide duct tape was placed on the anchor in the correct location.



Fig. 3.2 Rotary Hammer Drill

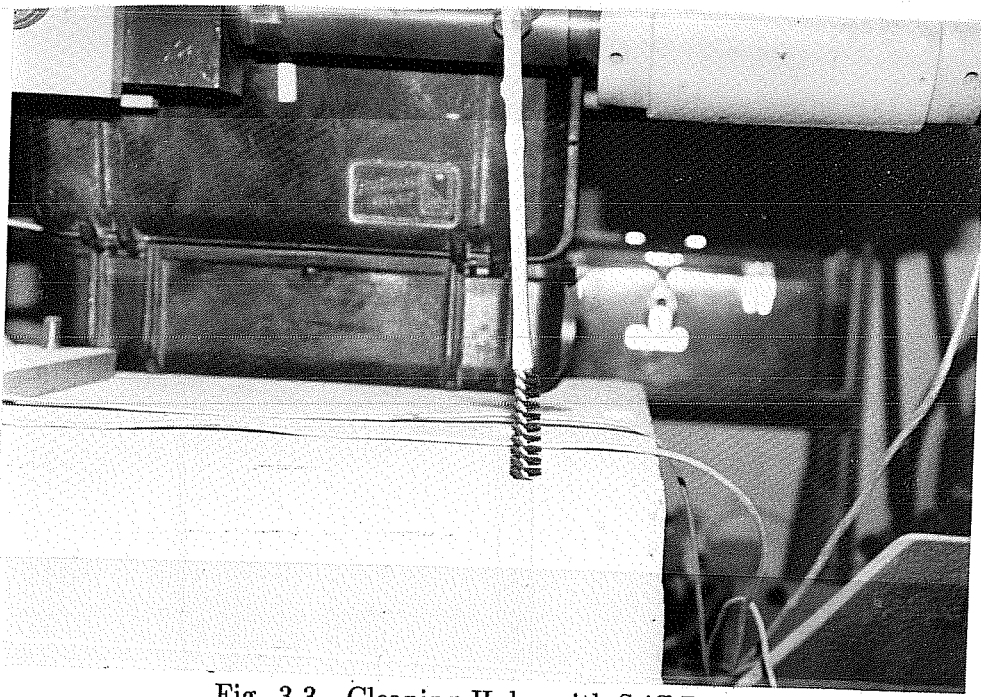

Fig. 3.3 Cleaning Holes with Stiff Brush



**3.3.3 Preparation of Adhesives.** Temperatures in the laboratory were often high. To assure that the adhesives were placed under favorable conditions, the adhesives were refrigerated prior to preparation. The adhesives came in three forms:

- 1) Automatic "gun" type applicators (Fig. 3.4)

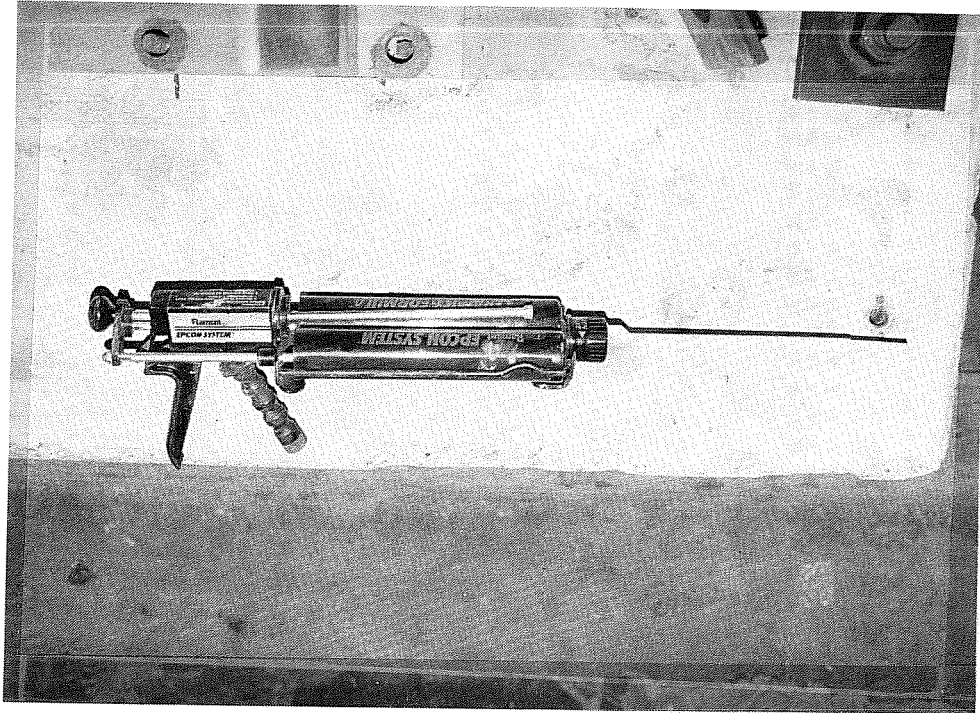

Fig. 3.4 "Gun" Type Adhesive Applicator

- 2) Two-component systems, mixed by hand
- 3) Glass capsules (Fig. 3.5)

The epoxy adhesives came either in the "gun" type applicator, or with the resin and catalyst in separate containers. The vinylester adhesive also came in a "gun" type applicator. Adhesives which were supplied with a "gun" applicator did not require proportioning and mixing prior to placement. Care was taken, however, to discard the first part of each package by pumping adhesive onto a paper towel until an even mixture was noted. When hand mixing was required, the two

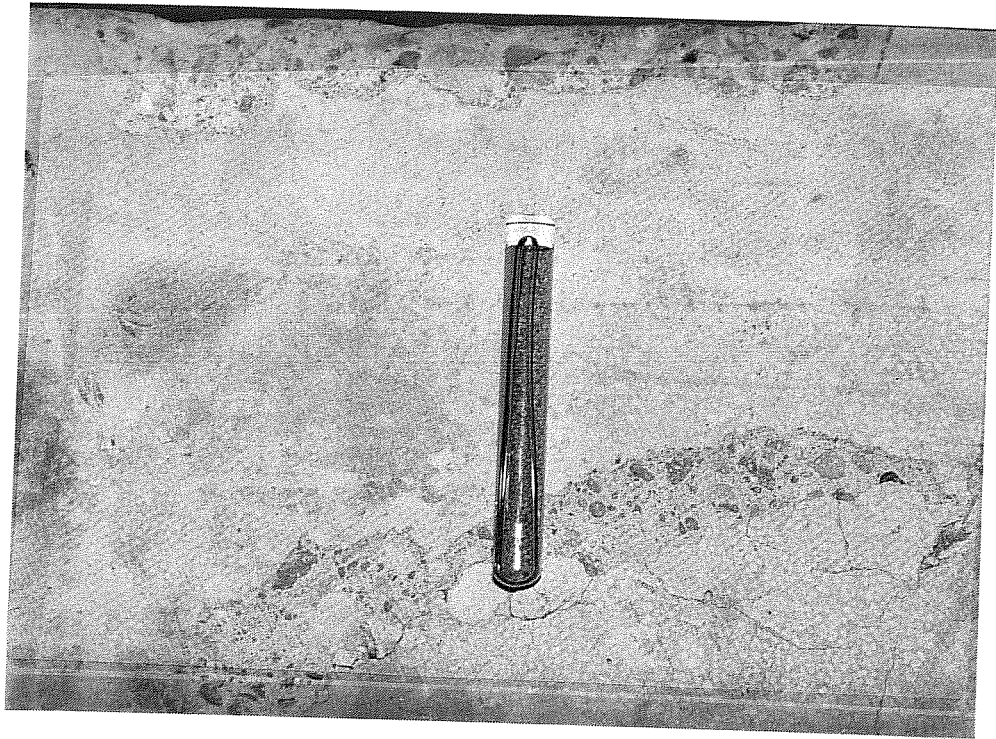

Fig. 3.5 Example of Glass Capsule for Polyester Resin

component systems were carefully measured according to manufacturers' recommendations. Once proportioned, the components were mixed using a paint mixer turned by a rotary drill for the time specified by the manufacturer.

The polyester adhesives were supplied either in a glass capsule, or as a two-component resin and catalyst system. No preparation of adhesive was necessary with the glass capsules. The two-component system contained a premeasured package of catalyst and a can of resin. The entire package of catalyst was added to a full can of resin and mixed by hand.

*3.3.4 Placement of Anchors.* All anchors were placed vertically. The adhesive was placed in the hole, and the threaded rod was inserted into the adhesive filled hole. Mixed adhesive was poured into the hole, filling it about  $1/3$  to  $1/2$  full. Adhesives with "gun" type applicators were placed by starting at the bottom of the hole and slowly moving the gun upward until the hole was  $1/2$  to  $1/3$  full. Threaded

rods were slowly pushed into the adhesive-filled hole while being rotated. Excess adhesive was removed from the concrete surface.

To place anchors with the glass capsule adhesive, the glass capsule was inserted into the hole. A threaded rod with an angled tip was forced into the hole with a rotary drill to break the capsule and mix the resin and catalyst components. Mixing and installation were complete when the anchor touched the bottom of the hole.

*3.3.5 Curing.* All anchors were cured at room temperature for 7 days before testing, except when a shorter curing time was requested by the manufacturer.

### 3.4 Testing Apparatus and Procedure

*3.4.1 Loading System.* The loading system is shown in Figs. 3.6, 3.7, and 3.8. Loads were applied to the anchors using a 100-ton, center-hole hydraulic ram and a reaction frame bearing on the concrete block. The reaction frame consisted of 2 structural steel channels (MC 6x18) placed back-to-back on a steel ring. This ring, 27 inches in diameter and 10 inches high, placed the compression reaction at a sufficient distance from the anchors to avoid any effect of local bearing stresses. Hydraulic pressure was supplied by a hand pump.

For the single anchor tests (Fig. 3.7), load was applied to the anchor through a 1 inch diameter, 36 inch long high strength steel rod running through the load cell at the top of the ram, and connected to a hardened steel shoe at the anchor end. The shoe, which had a 3/4-inch hole in its base plate, was placed over the threaded portion of the anchor protruding from the concrete surface. A washer and a heavy hex nut on the anchor secured the shoe to the anchor.

For the paired anchor tests (Fig. 3.8), a procedure similar to that for single anchor tests was used. The high-strength rod was 1-1/2 inches in diameter instead of 1 inch, and the loading shoe was different. For the paired anchor tests, two shoes were constructed—one for the 4- and 8-inch spacings, and a second for the 6-inch spacings. The load shoes (Fig. 3.9) consisted of a 1-1/2 inch hardened steel plate with 3/4-inch holes spaced at 4, 6, or 8 inches on center.

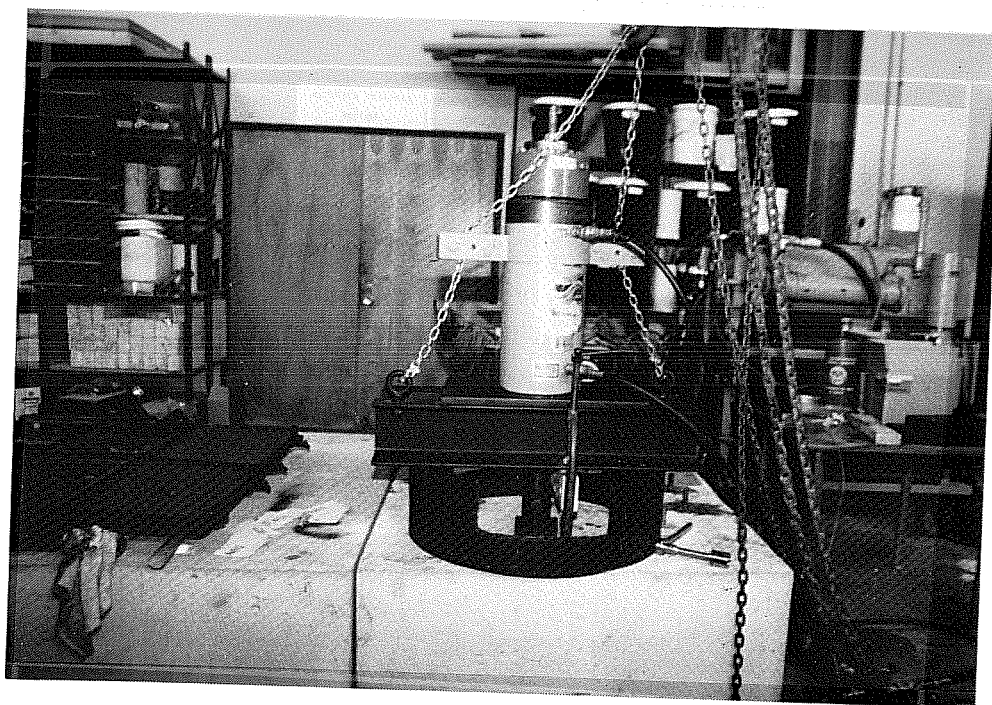

Fig. 3.6 Loading System

3.4.2 Instrumentation. *Photograph of* Applied load was measured using a Interface 100

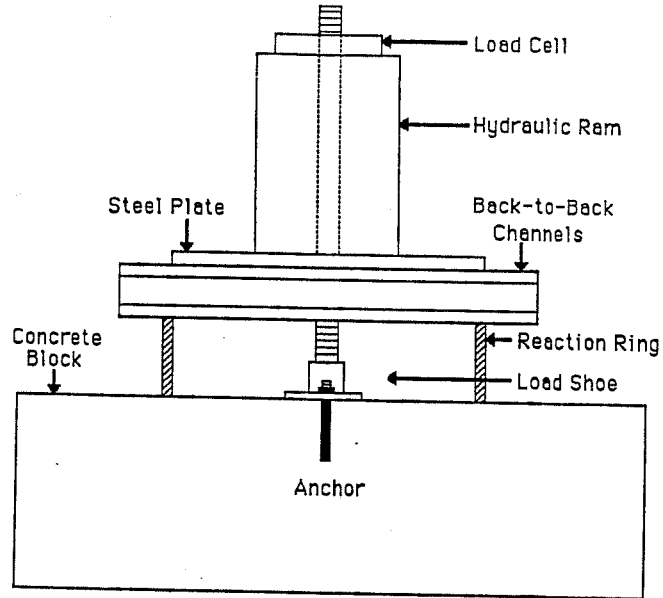

Fig. 3.7 Schematic Drawing of Loading System, Single Anchor Tests

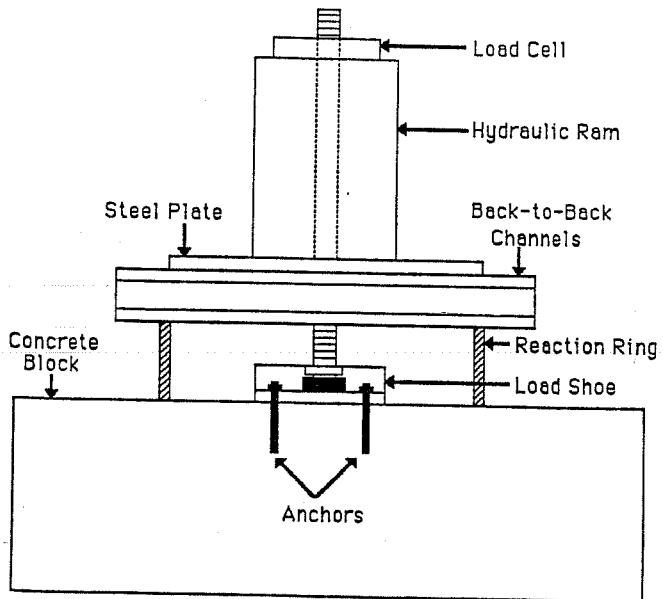
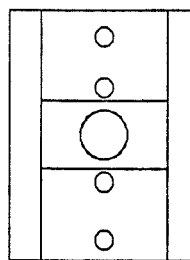
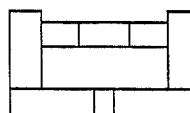

Fig. 3.8 Schematic Drawing of Loading System, Paired Anchor Tests



Top View



Front View

**Fig. 3.9 Load Shoe for Paired Anchor Tests**



## CHAPTER 4. TENSILE BEHAVIOR OF SINGLE ANCHORS

### 4.1 General

Typical results from the tests using single anchor, fully bonded, and partially bonded anchors are presented in separate sections. Test results are presented according to failure mode. In Appendix A, complete test results are given for each test.

Results presented in this thesis apply only for the anchors tested in this study and for the conditions under which they were studied. The results given should not be construed as an endorsement of any particular brand or type of adhesive anchor. There are many factors not included in this study, including effects of environmental exposure.

### 4.2 Tensile Behavior of Fully Bonded Single Anchors

*4.2.1 Failure by Concrete Cone with Adhesive Core.* All but one of the 26 tests in this phase exhibited a failure of this type (Fig. 4.1). The anchors failed by pullout of a single concrete cone with an average depth between 1 and 2 inches, and an adhesive core surrounding the anchor below the core pulled out of the concrete. The concrete cones varied widely in depth and base diameter. Although the average cone depths were between 1 and 2 inches, these depths ranged from 1/4 inch to 4 inches. Similarly, cone diameters at the surface of the concrete varied between 2 and 24 inches. The depth and diameter of the cone also seemed to be affected by the proximity of reinforcing steel. When the anchor was placed close to reinforcing steel, the cones tended to be shallower and of a larger diameter. This occurred in only two cases, and those tests were repeated using anchors placed farther from the reinforcing steel.

*4.2.2 Failure by Yield and Fracture of Anchor Steel.* Failure by fracture of the anchor steel occurred in only one test with a 6-inch embedment. Considerable yielding was observed prior to failure. The anchor steel failed at the concrete surface.

Several of the anchors that formed a cone also exhibited yielding of the anchor prior to ultimate load. For these anchors, yield should have occurred at



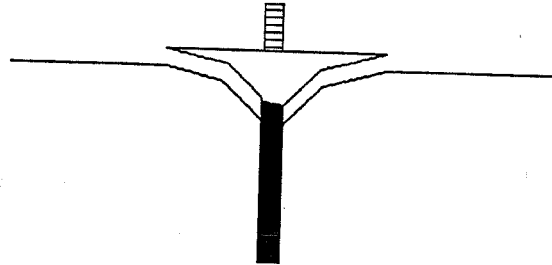

Fig. 4.1 Concrete Cone with Adhesive Core, Failure Mode

approximately 25 kips. Of the 25 anchors which formed a cone, 7 had ultimate loads of 25 kips or more. All of these had an embedment depth of 6 inches.

### 4.3 Tensile Behavior of Partially Bonded Single Anchors

*4.3.1 Failure by Pullout of Adhesive Core.* Thirty-six tests were performed on partially bonded anchors to gain a better understanding of the adhesive bond stress distribution along the anchor. Debonding lowered the point of load transfer so that a concrete cone was not likely to form. If cone failure is prevented, the capacity of the partially bonded anchor is dependent only on adhesive bond. Of the 36 tests completed in this phase, 35 failed by pullout of an adhesive core (Fig. 4.2). Debonding of the top 2 inches of the anchor length was sufficient to eliminate concrete cone formation.

*4.3.2 Failure by Yield and Fracture of Anchor Steel.* Only one anchor failed by fracture of steel in this test phase. That anchor failed at the surface of the concrete after exhibiting a great deal of yielding.

Of the 35 anchors which failed by pullout, 16 failed at a load exceeding the minimum specified yield load of 25 kips.

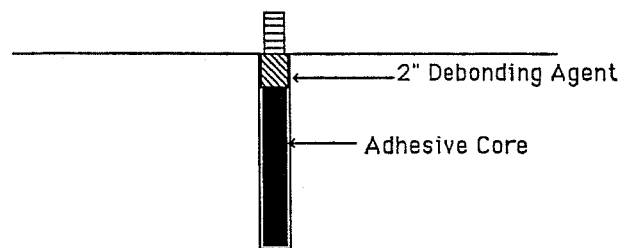

Fig. 4.2a Initial Configuration

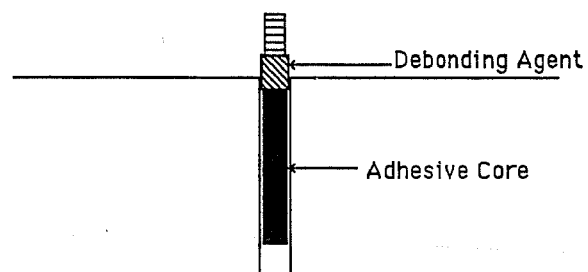

Fig. 4.2b Adhesive Core Failure Mode



## CHAPTER 5. BEHAVIORAL MODELS FOR SINGLE ADHESIVE ANCHORS

### 5.1 General

Several theories have been proposed for the distribution of bond stress along the depth of an adhesive anchor. For purposes of design, the bond stress is often assumed to have a uniform distribution along the length of the anchor. A uniform distribution is reasonably consistent with test results for short embedments. As noted in Ref. 1, it does permit an approximate estimation of cone depth. However, the uniform stress approach significantly overestimates the capacity of longer embedments. It is not discussed further here.

### 5.2 Elastic Model for Bond Stress Distribution

*5.2.1 Development of Mathematical Model.* The bond stress distribution that best fits the observed behavior of adhesive anchors can be derived from an elastic analysis. The elastic analysis is concerned only with the bond stress at the interface between the adhesive and the concrete. The strength of the concrete itself is not considered. The total energy in the system (Fig. 5.1) is given by the following equations:

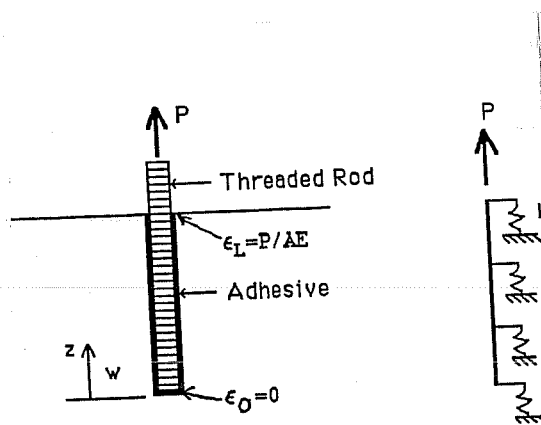

Fig. 5.1 Model of Adhesive Anchor System for Elastic Analysis

Internal Strain Energy-*Due to Threaded Rod:*

$$\Pi_{tr} = \frac{l}{2} \int_0^l \int_A \sigma \epsilon \, dA \, dz \quad (\text{Eq. 5.1})$$

where:

 $\Pi_{tr}$  = internal strain energy of deformation of the anchor $l$  = anchor embedment length $A$  = anchor cross-sectional area $\epsilon$  = axial strain in anchor $\sigma$  = axial stress in anchor

Since:

 $\epsilon = \frac{dw}{dz} \equiv w'$ , where  $w$  = axial displacement of anchor, $\sigma = \epsilon E = w' E$ , where  $E$  = elastic modulus of anchor steel, $\int_A dA = A$ 

then:

$$\Pi_{tr} = \frac{l}{2} \int_0^l E A (w')^2 \, dz \quad (\text{Eq. 5.2})$$

*Due to Adhesive:*

$$\Pi_a = \frac{l}{2} \int_0^l k w^2 \, dz \quad (\text{Eq. 5.3})$$

where:

 $\Pi_a$  = internal strain energy of deformation of the adhesive $k$  = shearing stiffness of the adhesive

External Work-

$$\Pi_e = -P w(l) \quad (\text{Eq. 5.4})$$

where  $P$  = tensile load applied to the anchor

Total Energy-

$$\Pi_{tr} = \frac{1}{2} \int_0^l E A (w')^2 dz + \frac{1}{2} \int_0^l k w^2 dz - P w(l) \quad (\text{Eq. 5.5})$$

Minimizing the total energy with respect to  $w$  yields the following equation:

$$w'' - \frac{k}{E A} w = 0 \quad (\text{Eq. 5.6})$$

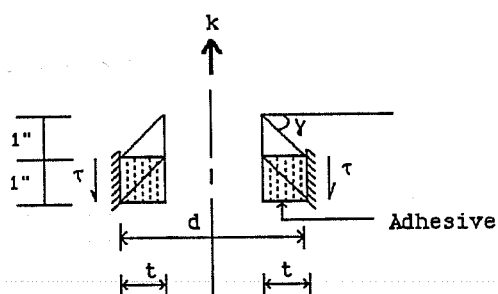

Fig. 5.2 Shearing Stiffness of Adhesive

The shearing stiffness of the adhesive,  $k$  (see Fig. 5.2), is given by the following equation:

$$k = u \Pi d \quad (\text{Eq. 5.7})$$

where:  $u$  = shearing stress of adhesive,  $G$  = shear modulus.

Since  $u = \gamma G$ ,  $\gamma = (1 / t)$ , where  $\gamma$  = shearing strain of adhesive,  $t$  = thickness of adhesive layer, then  $u = (G / t)$ , which gives

$$k = \frac{G \Pi d}{t} \quad (\text{Eq. 5.8})$$

where the units of  $k$  are  $kips/in^2$ .

With Eq. 5.8, then Eq. 5.6 can be rewritten as:

$$w'' - \frac{G \Pi d}{t E A} w = 0 \quad (\text{Eq. 5.9})$$

This differential equation can be solved to give:

$$w(z) = C_1 e^{\lambda z} + C_2 e^{-\lambda z} \quad (\text{Eq. 5.10})$$

$$\text{where } \lambda = \sqrt{\frac{G \Pi d}{t E A}}.$$

Imposing boundary conditions yields the following equations:

$$w(z) = \left( \frac{P}{E A \lambda} \right) \frac{\cosh(\lambda z)}{\sinh(\lambda l)} \quad (\text{Eq. 5.11})$$

where  $l$  = the anchor length and  $P$  = the applied load.

Then, solving for  $P$  yields:

$$P = \left( w(z) E A \lambda \right) \frac{\sinh(\lambda l)}{\cosh(\lambda z)} \quad (\text{Eq. 5.12})$$

Since  $w(l) = t u_{max} / G$  for  $z = l$ ,

$$P = u_{max} \left( \frac{t E A}{G} \right) \tanh(\lambda l) \quad (\text{Eq. 5.13})$$

$$\lambda = \sqrt{\frac{G \pi d}{t E A}}$$

$$\frac{t E A}{G} = \frac{\pi d}{\lambda^2}$$

$$P = u_{max} \frac{\pi d}{\lambda^2} \tanh(\lambda l) \quad (\text{Eq. 5.14})$$

In order to make the analysis general,  $\lambda$  is replaced with a variable,  $\lambda'$ , that is dependent only on adhesive properties:

$$\lambda = \sqrt{\frac{4 G \pi}{\pi d^2 t E}} \quad (\text{Eq. 5.15})$$

Remove the diameter to make  $\lambda'$  dependent only on the adhesive:

$$\lambda' = \lambda \sqrt{d} = \sqrt{\frac{4 G}{t E}} \quad (\text{Eq. 5.16})$$

This gives the following equation in terms of  $\lambda'$ :

$$P = \left( \frac{\pi u_{max} d^{1.5}}{\lambda'} \right) \tanh\left(\frac{\lambda' l}{\sqrt{d}}\right) \quad (\text{Eq. 5.17})$$

**5.2.2 Application of Elastic Model to Partially Bonded Anchors.** Equation 5.17 defines the behavior of an adhesive anchor as predicted by the elastic model. The effect of pullout of a concrete cone, however, is not reflected. Equation 5.17 therefore describes the capacity of a partially bonded anchor, with no slip along the epoxy-concrete interface.

**5.2.3 Correlation of Elastic Theory with Test Data.** Test Phase 2 consisted of tensile tests on single anchors with the upper 2 inches debonded. Embedment depths of 4, 6, and 8 inches, corresponding to bonded lengths of 2, 4, and 6 inches,



respectively, were tested. Debonding the top 2 inches eliminated the influence of concrete cone failure on anchor behavior.

For each adhesive, a maximum bond stress,  $u_{max}$ , was found using the anchors with a 2-inch bonded length. For short bonded lengths (for example, 2 inches), the bond stress distribution can be assumed uniform, because the hyperbolic tangent of  $x$  is approximately equal to  $x$  for small values of  $x$ . The bond capacity is therefore given as:

$$P = \pi d u_{max} l_b \quad (Eq. 5.18)$$

where:  $l_b =$  bonded lengths = 2 inches.

From the above equation and the experimentally observed capacities, a value was calculated for  $u_{max}$  for each adhesive.

For each adhesive, after finding  $u_{max}$  the corresponding value of  $\lambda'$  was determined by a least-squares fit between the data points and the curve of Equation 5.17, using  $l = l_b$ . In fitting the curve to the available data, the tests with 2-inch and 4-inch bonded lengths were used. The tests with a 6-inch bonded length were omitted, because they were in the range of steel yielding. Inclusion of points influenced by steel yielding would have produced an artificially low value for the capacity of the adhesive.

The resulting curves are shown in Figs. 5.3a-5.3f. The curves indicate that the elastic solution does fit the experimental data very well. This is not surprising since the constant  $\lambda$  was determined on that basis. It should also be noted that these curves were produced with a small amount of data. More data involving ultimate loads below yielding is needed to produce more accurate curves. Also, because these curves were produced using only the data from the partially bonded anchor tests, they apply only to those tests.

Also shown on the curves is a horizontal line corresponding to  $A_s f_{ut}$ . Two of the curves approach asymptotes below  $A_s f_{ut}$ , implying that steel failure would be impossible with those adhesives. However, other tests on these adhesives [1] showed that all of the adhesives tested are strong enough to result in failure by steel fracture.

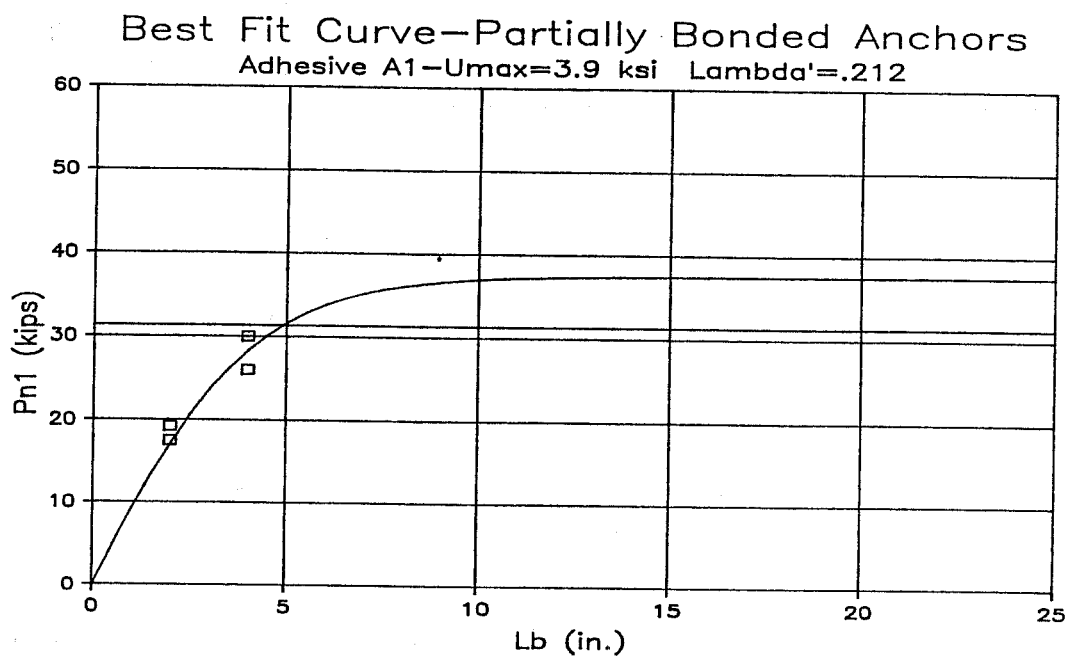

Fig. 5.3a Load vs. Embedment Curve for Partially Bonded Anchors, Adhesive A1

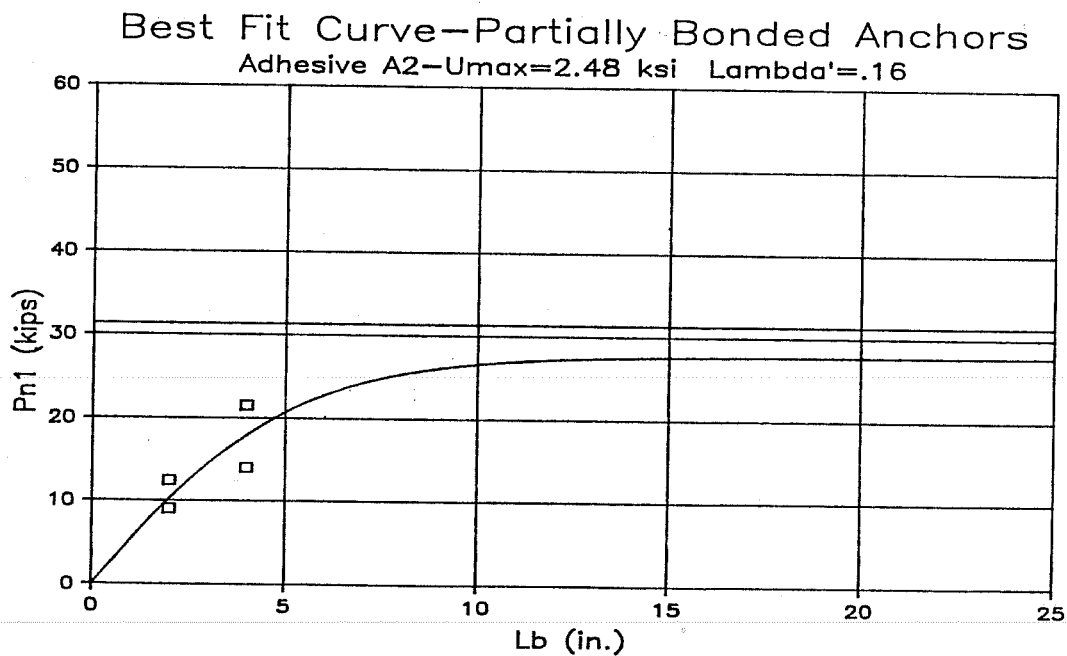

Fig. 5.3b Load vs. Embedment Curve for Partially Bonded Anchors, Adhesive A2

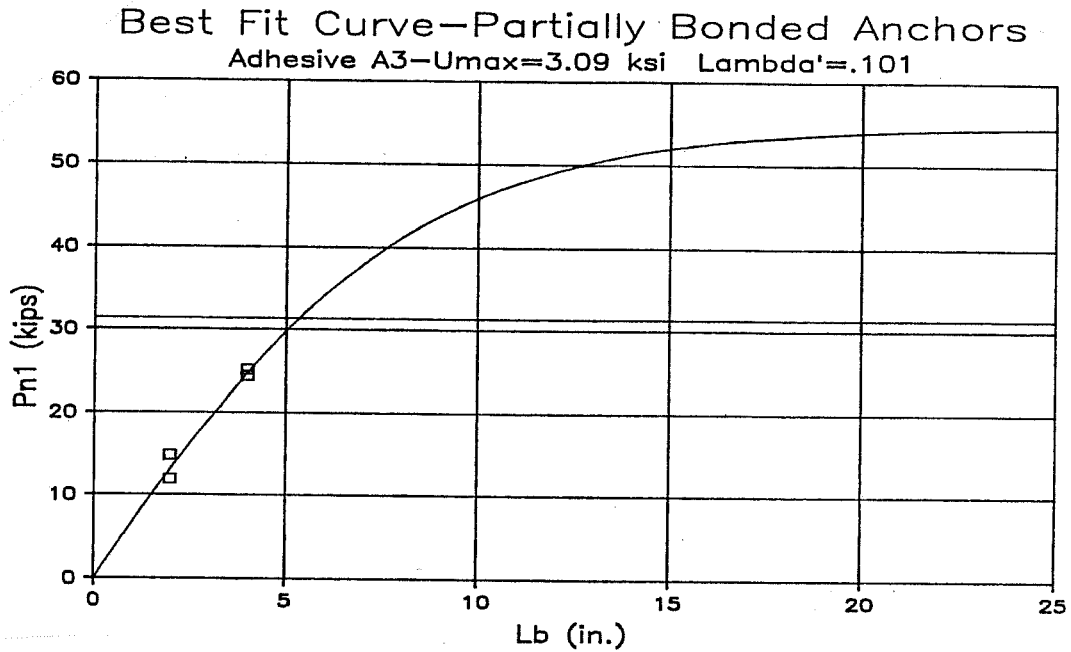

Fig. 5.3c Load vs. Embedment Curve for Partially Bonded Anchors, Adhesive A3

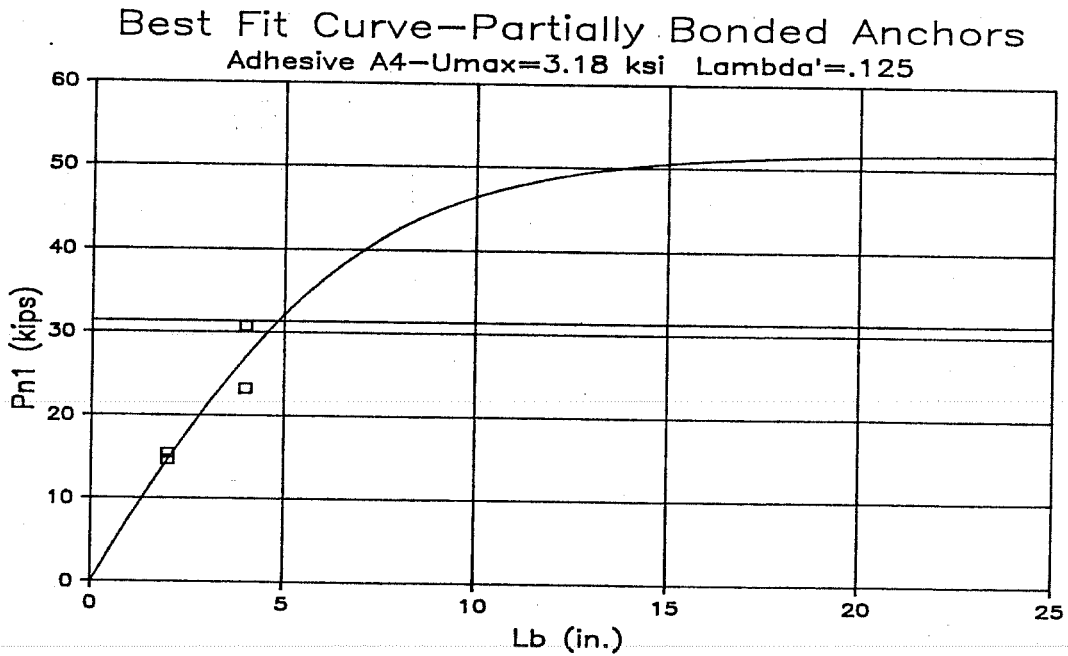

Fig. 5.3d Load vs. Embedment Curve for Partially Bonded Anchors, Adhesive A4

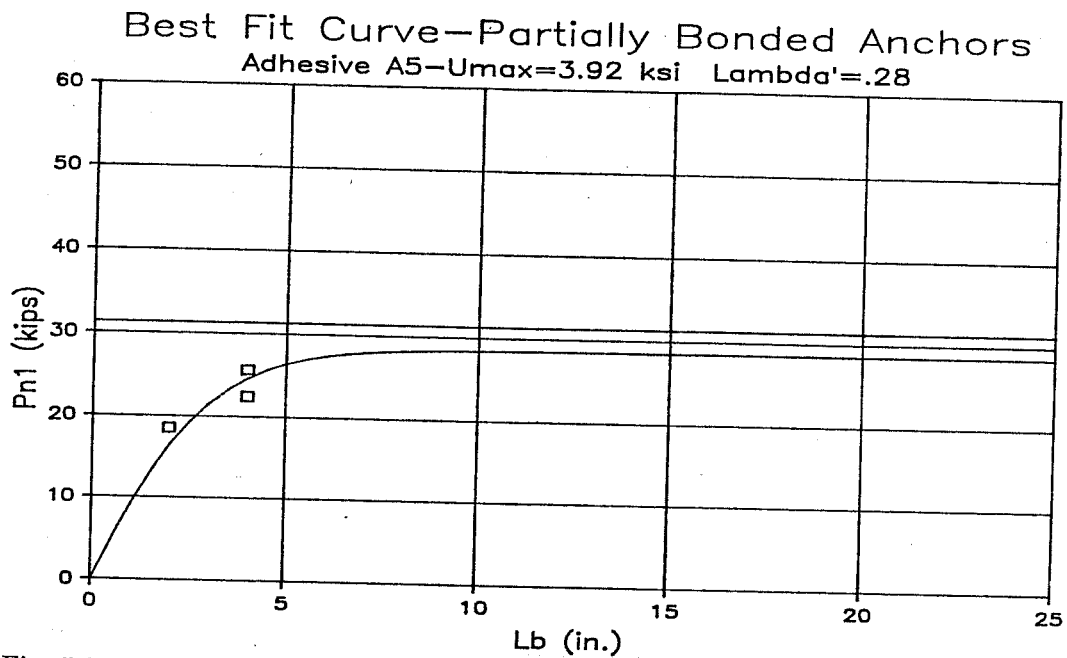

Fig. 5.3e Load vs. Embedment Curve for Partially Bonded Anchors, Adhesive A5

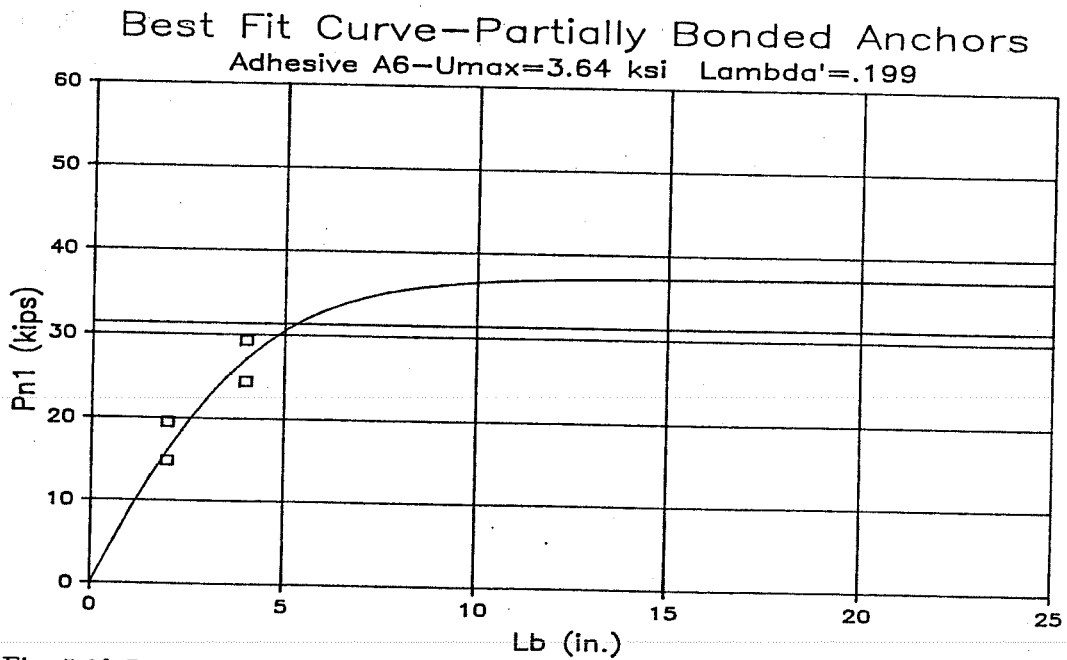

Fig. 5.3f Load vs. Embedment Curve for Partially Bonded Anchors, Adhesive A6

This apparent discrepancy could be resolved by conducting more tests on partially bonded anchors embedded less than the depth required to produce yielding.

In any event, the elastic model does describe the distribution of bond stress along the anchor, and can be used to predict the capacity of a partially bonded anchor. The elastic model indicates that past a certain embedment length, an increase in embedment does not increase the capacity of the anchor. Problems occur, however, when the elastic model is extended to fully bonded anchors.

### 5.3 Application of Elastic Model to Fully Bonded Adhesive Anchors

**5.3.1 General.** In order to extend the elastic approach for partially bonded anchors to the case of fully bonded anchors, the effects of cone pullout must be included.

**5.3.2 Stages of Behavior.** The behavior of adhesive anchors can be described in terms of three cases.

#### Case 1

Case 1, shown in Fig. 5.4, involves a partially bonded anchor. The maximum bond stress,  $u_{max}$ , occurs at the top of the bonded length,  $l_b$ . The capacity of the anchor in Case 1,  $P_{n1}$ , can be found by applying elastic theory, described in detail in Section 5.1. The following result is obtained:

$$P_{n1} = \left( \frac{\pi u_{max} d^{1.5}}{\lambda'} \right) \tanh\left(\frac{\lambda' l_b}{\sqrt{d}}\right) \quad (\text{Eq. 5.19})$$

where  $d$  = diameter of the hole,  $l_b$  = bonded length of the anchor,  $l_e$  = total embedded length of anchor, and  $l_b = l_e - 2$  inches.

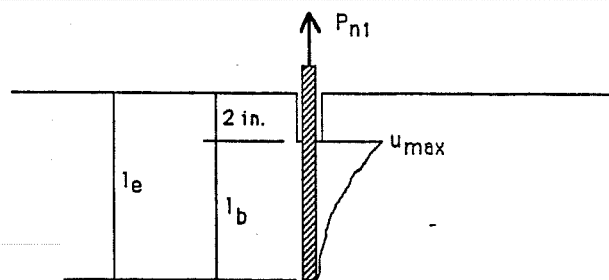

Fig. 5.4 Partially Bonded Anchor, Case 1

### Case 2

Case 2, shown in Fig. 5.5(b), involves a fully bonded anchor when a concrete pullout cone is forming. The depth of the cone is taken here as  $l_c$ . As shown in Fig. 5.5(a), the cone usually exhibits a steeper angle near the anchor and a lesser angle farther from the anchor. For purposes of analysis, these angles can be approximated by a single average cone angle,  $\alpha$ .

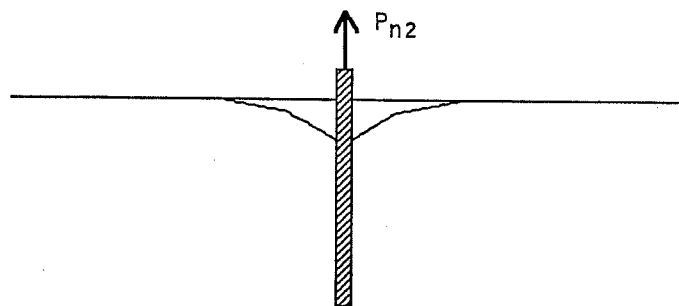

Fig. 5.5a Actual Shape of Concrete Cone

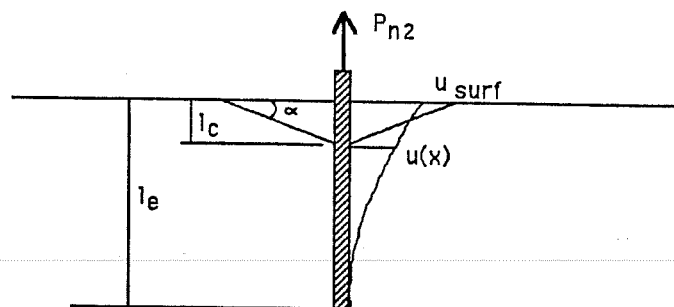

Fig. 5.5b Fully Bonded Anchor as Concrete Cone Begins to Form, Case 2

If a combined failure mechanism exists at the time of cone formation, the capacity of the anchor in Case 2,  $P_{n2}$ , is the sum of the concrete cone capacity and the adhesive bond capacity between the cone tip and the end of the anchor:

$$P_{n2} = P_{cone} + P_{bond} \quad (Eq. 5.20)$$

$$P_{cone} = \pi f_t \left( \frac{l_c}{\tanh(\alpha)} \right)^2 \quad (Eq. 5.21)$$

where:

$$f_t = 4 \sqrt{f'_c}$$

$$P_{bond} = \int_0^{l_e - l_c} u(x) \pi d dx \quad (Eq. 5.22)$$

where:  $u(x)$  = bond stress at a distance  $x$  from the bottom of the hole,  
 $l_c$  = depth of cone.

$$u(x) = \left( \frac{P \lambda'}{\pi d^{1.5}} \right) \frac{\cosh\left(\frac{\lambda' x}{\sqrt{d}}\right)}{\sinh\left(\frac{\lambda' l_e}{\sqrt{d}}\right)} \quad (Eq. 5.23)$$

$$P_{bond} = \int_0^{l_e - l_c} \left( \frac{P \lambda'}{\pi \sqrt{d}} \right) \frac{\cosh\left(\frac{\lambda' x}{\sqrt{d}}\right)}{\sinh\left(\frac{\lambda' l_e}{\sqrt{d}}\right)} dx \quad (Eq. 5.24)$$

The final form for  $P_{n2}$  is:

$$P_{n2} = f_t \pi \left( \frac{l_c}{\tanh(\alpha)} \right)^2 \frac{\sinh\left(\frac{\lambda' l_e}{\sqrt{d}}\right)}{\sinh\left(\frac{\lambda' l_e}{\sqrt{d}}\right) - \sinh\left(\frac{\lambda'(l_e - l_c)}{\sqrt{d}}\right)} \quad (Eq. 5.25)$$

where  $\alpha$  = single average cone angle.

### Case 3

Case 3, shown in Fig. 5.6, occurs after the cone has formed. The concrete cone no longer contributes to the anchor capacity. The bond stress at the tip of the cone becomes  $u_{max}$ . The capacity of the anchor in Case 3,  $P_{n3}$ , is the bond capacity over the remaining bonded length:

$$P_{n3} = \left( \frac{\pi u_{max} d^{1.5}}{\lambda'} \right) \tanh \left( \frac{\lambda' (l_e - l_c)}{\sqrt{d}} \right) \quad (Eq. 5.26)$$

The load applied to the anchor in Case 3,  $P_3$ , is related to the Case 2 capacity:

$$P_3 = P_{bond} + (DF) P_{cone} \quad (Eq. 5.27)$$

where (DF) is a dynamic load factor associated with formation of the concrete cone. If the capacity  $P_{n3}$  from Equation 5.26 is less than or equal to the applied load  $P_3$ , the capacity from adhesive bond will be insufficient, and the anchor head will slip. If the capacity  $P_{n3}$  exceeds the applied load  $P_3$ , the anchor will not slip at the unloaded end, and its capacity will continue to increase after the cone forms.

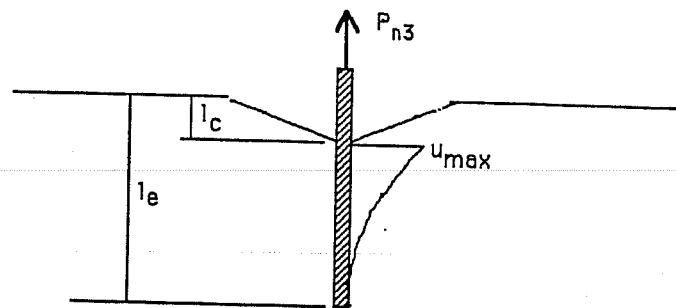

Fig. 5.6 After Concrete Cone has Formed, Case 3



## 5.4 Discussion of Elastic Model

*5.4.1 Advantages of Elastic Theory.* The one-dimensional elastic theory reviewed here produces acceptable results for the limited number of partially bonded anchors tested in this study. With a larger number of data points, the results should be more accurate. The formulation is reasonably simple to use. Each adhesive can be tested to determine its  $u_{max}$  and  $\lambda'$ . Once these values are established, Equation 5.19 is a simple equation to use to predict the capacity of a partially bonded anchor.

*5.4.2 Disadvantages of Elastic Theory.* However, this one-dimensional elastic theory has one serious drawback. It gives no consistent way of predicting the depth of the concrete cone. Numerous attempts to develop an equation for the cone depth were unsuccessful. One attempt assumed a simultaneous failure of cone and bond with the bond stress at the base of the cone equal to  $u_{max}$ . However, this assumption is unjustified, and produces cone depths much lower than those encountered experimentally. Use of those computed cone depths also produces values of  $P_{n3}$  which tend to be too large.

The equation for predicting  $P_{n2}$  is extremely sensitive to cone depth. For typical experimental cone depths, the  $P_{n2}$  capacities predicted from Equation 5.25 appear too large.

*5.4.3 Resolution.* Values of final capacity  $P_{n3}$  calculated using elastic theory and experimental cone depths appear to be accurate. Typical cone depths ranged between 1.5 and 2 inches. Table 5.1 shows a comparison between actual ultimate loads of fully bonded anchors and computed  $P_{n3}$  values using an observed cone depth of 2 inches.

Experimental data, shown in Figures 5.7(a)-5.7(f), also shows that fully bonded anchors have only slightly higher capacities than do partially bonded anchors of the same embedment length. Apparently, the capacity of either a fully bonded anchor or a partially bonded anchor can be predicted using Equation 5.17 with an  $l$  equal to the embedment length,  $l_e$ , less the cone depth,  $l_c$ .

*5.4.4 Conclusions Regarding Use of Elastic Theory.* The one-dimensional elastic theory used is sufficiently accurate to predict the capacity of anchors in cases where cone formation is not a factor. For partially bonded anchors, the theory works well and is simple to use. There are many advantages to using partially bonded

Table 5.1 Actual vs. Computed Capacity for Fully Bonded Anchors

Adhesive	Embedment (in.)	Pn-Exper. (kips)	Pn-Calc. (kips)	Exper/ Calc.
A1	4	20.74	17.04	1.22
	4	19.5	17.04	1.14
	6	30.5	28.26	1.08
	6	20.25	28.26	0.72
	6	23.9	28.26	0.85
A2	4	14.64	10.21	1.43
	4	15.0	10.21	1.47
	6	21.47	17.99	1.19
	6	25.6	17.99	1.42
A3	4	20.25	13.09	1.55
	4	17.1	13.09	1.31
	6	28.5	24.77	1.15
	6	32.45	24.77	1.31
A4	4	9.0	14.58	0.62
	4	17.6	14.58	1.21
	6	26.25	27.03	0.97
	6	20.0	27.03	0.74
A5	4	21.0	16.27	1.29
	4	23.2	16.27	1.43
	6	22.9	24.57	0.93
	6	30.2	24.57	1.23
A6	4	18.8	16.04	1.17
	4	21.5	16.04	1.34
	6	25.1	27.07	0.93
	6	30.0	27.07	1.11

anchors. Partially bonded anchors produce no concrete cone or spall, making them more aesthetically pleasing than fully bonded anchors. Also, if repairs must be made, no concrete must be replaced with a partially bonded anchor. The debonding material for a partially bonded anchor might actually protect the adhesive from some environmental effects.

While the fully bonded case cannot be fully described with the one-dimensional elastic theory, the equation for a partially bonded anchor can be adapted for a fully bonded anchor by neglecting the top 2 inches of embedment, for anchors with diameters near 5/8-inches. This method gives conservative results as discussed in Section 5.3.3.

In order to better describe the fully bonded anchor case, additional research should be conducted. The elastic theory should be expanded into two and three

dimensions to account for movement of the concrete and for thickness of the glue line. This additional research should involve many more tests below the yield point of the steel. This will allow a more accurate definition of  $\lambda'$ .

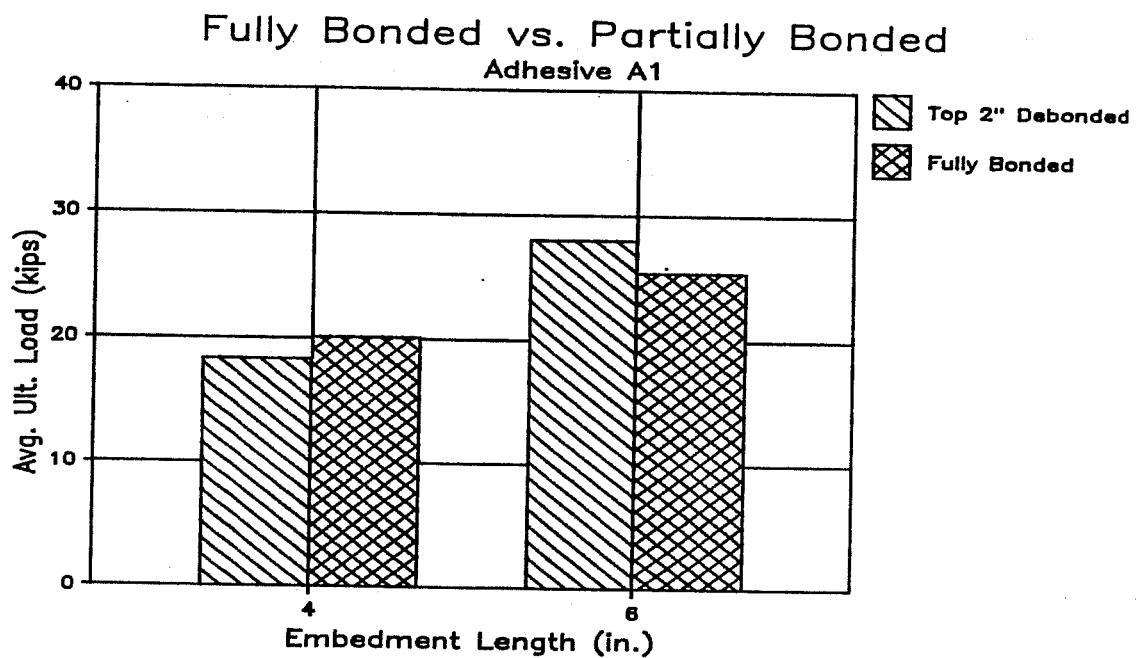

Fig. 5.7a Capacities of Fully Bonded vs. Partially Bonded Anchors, Adhesive A1

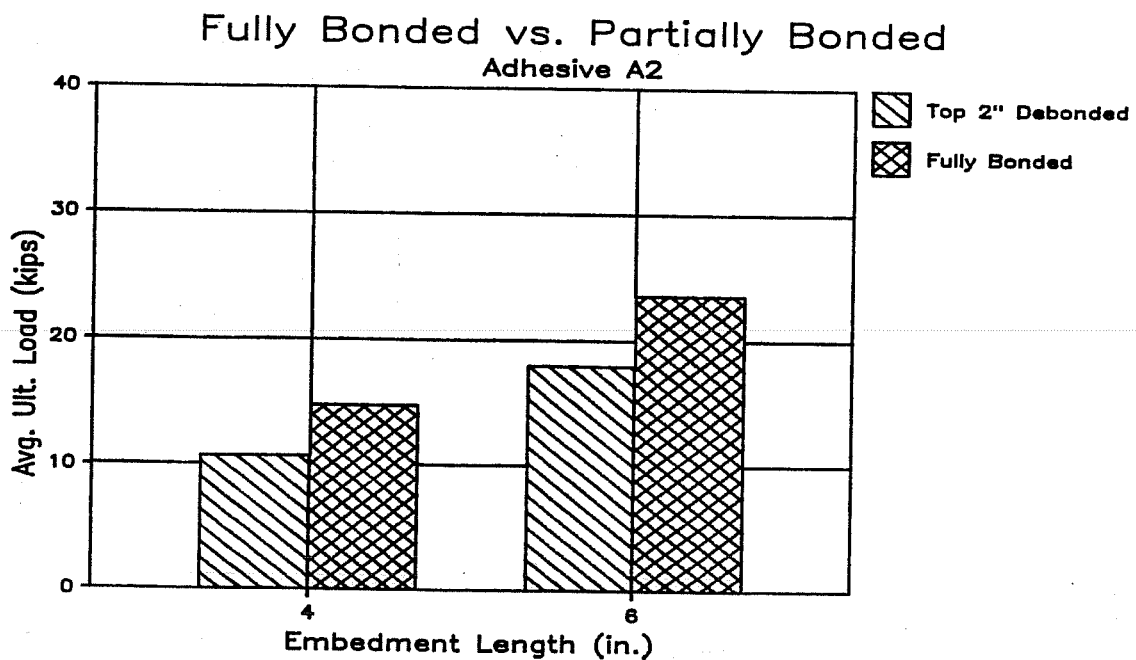

Fig. 5.7b Capacities of Fully Bonded vs. Partially Bonded Anchors, Adhesive A2

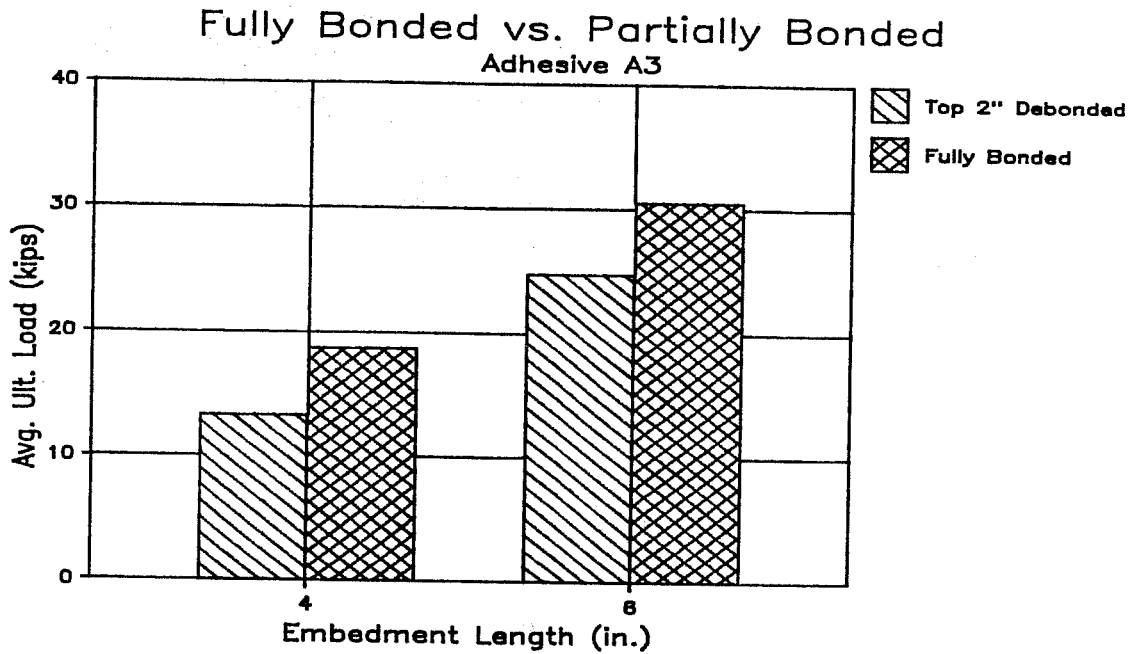

Fig. 5.7c Capacities of Fully Bonded vs. Partially Bonded Anchors, Adhesive A3

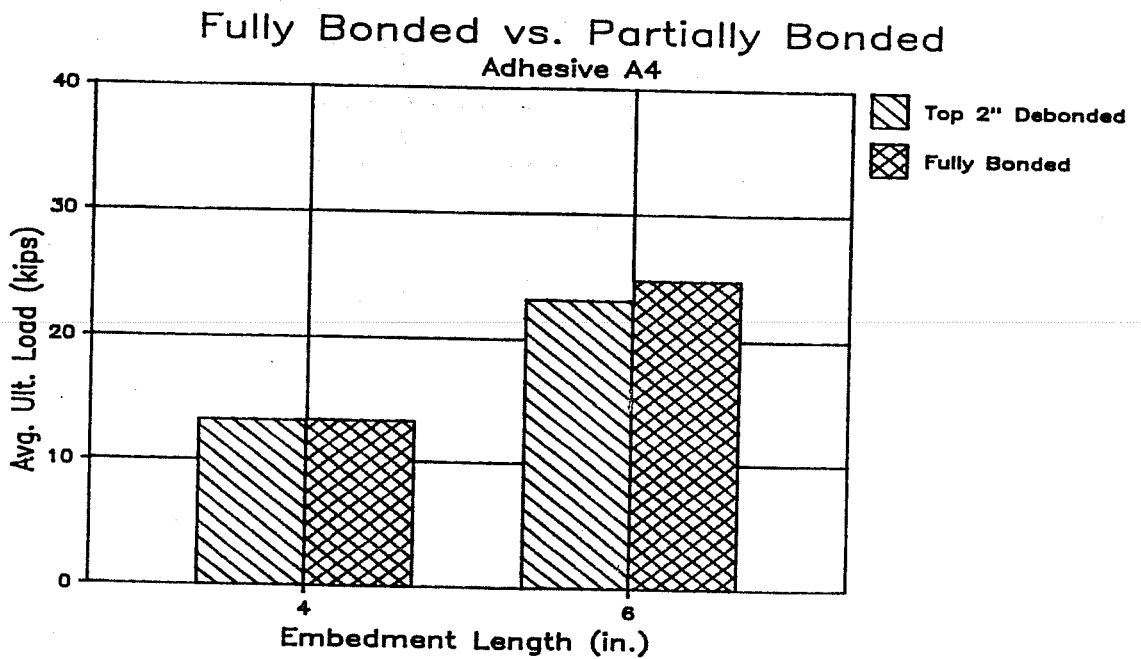

Fig. 5.7d Capacities of Fully Bonded vs. Partially Bonded Anchors, Adhesive A4

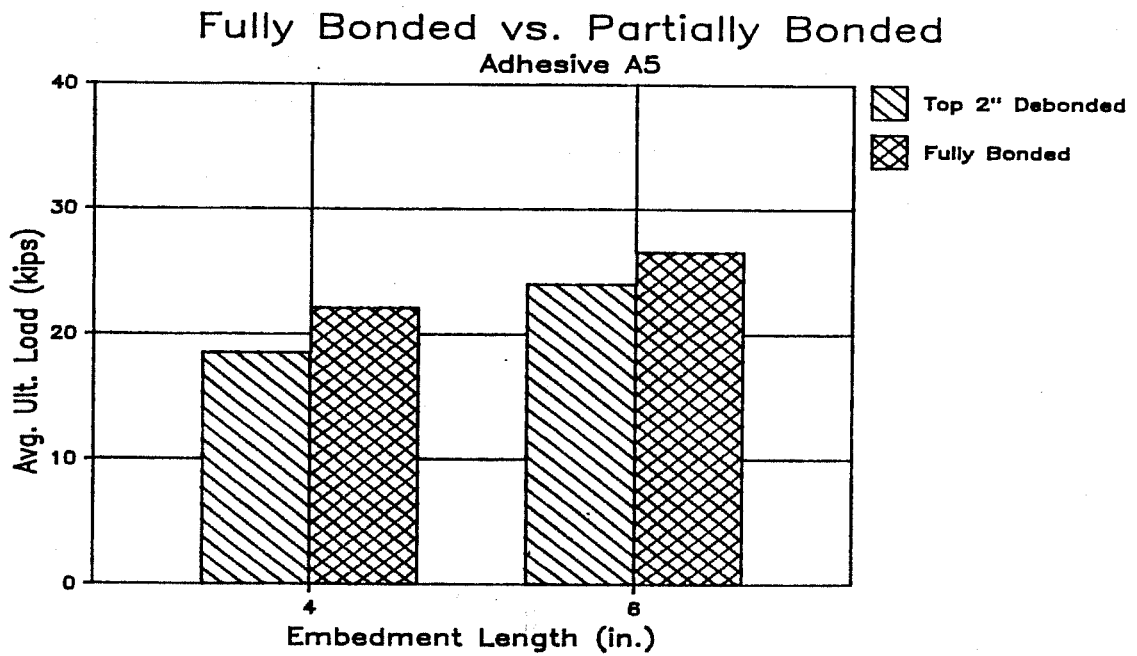

Fig. 5.7e Capacities of Fully Bonded vs. Partially Bonded Anchors, Adhesive A5

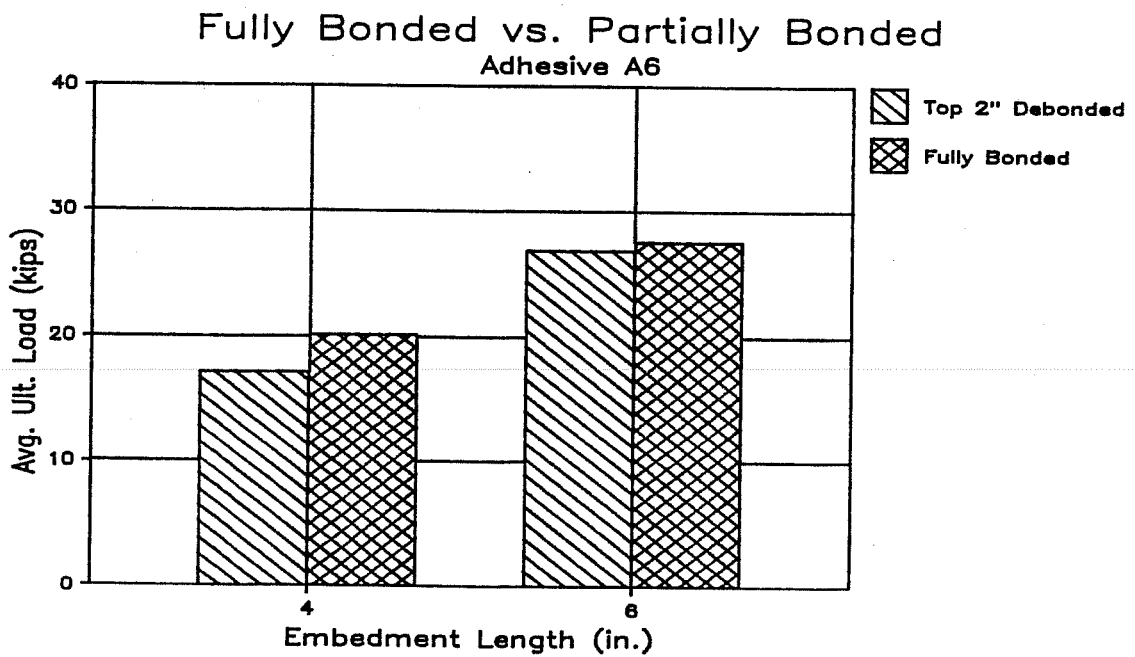

Fig. 5.7f Capacities of Fully Bonded vs. Partially Bonded Anchors, Adhesive A6



## CHAPTER 6. TENSILE BEHAVIOR OF FULLY BONDED PAIRED ANCHORS AT VARIOUS SPACINGS

### 6.1 General

In this chapter, typical results from tests on paired anchors are presented and discussed. All the anchors in these tests were fully bonded over an embedment depth of 8 inches. The results in this chapter are presented by failure mode. Complete test results are given in Appendix B.

### 6.2 Failure by Concrete Cones with Adhesive Cores

Each of the 36 tests developed concrete cones around both anchors, with adhesive cores below the cone (Fig. 6.1). The diameter of the concrete cones around each anchor ranged from 2 inch to 20 inches. The depth of these cones ranged from 1/2 inch to 5 inches. On the average, however, as the spacing increased both the diameter and depth decreased (Figs. 6.2 and 6.3). Also, as the spacing increased, the number of overlapping cones decreased. At an 8-inch spacing, 9 of the 12 tests exhibited individual cones for each anchor, while at a 4-inch spacing, 11 of 12 tests exhibited a combined pullout cone.

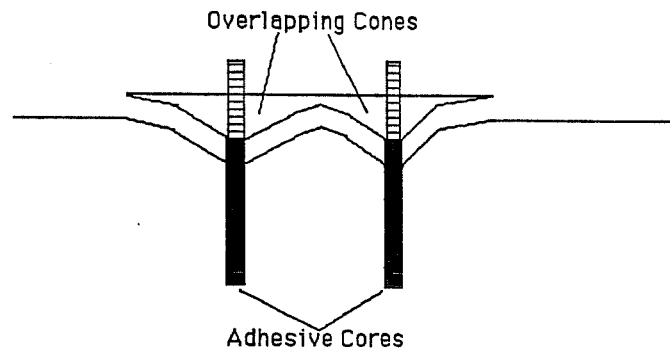

Fig. 6.1 Concrete Cones with Adhesive Cores, Failure Mode



### 6.3 Failure by Yield and Fracture of Anchor Steel

While all tests showed some concrete cone formation, several involved steel fracture in one anchor of the pair. The number of tests showing fracture of steel decreased with decreasing spacing. Correspondingly, the average ratio of experimental capacity to calculated capacity of all tests also decreased with decreased spacing (Fig. 6.4). This decrease in load, however, was not dramatic. The average ratio at a 4-inch spacing was 0.95, while at an 8-inch spacing it was 0.98.

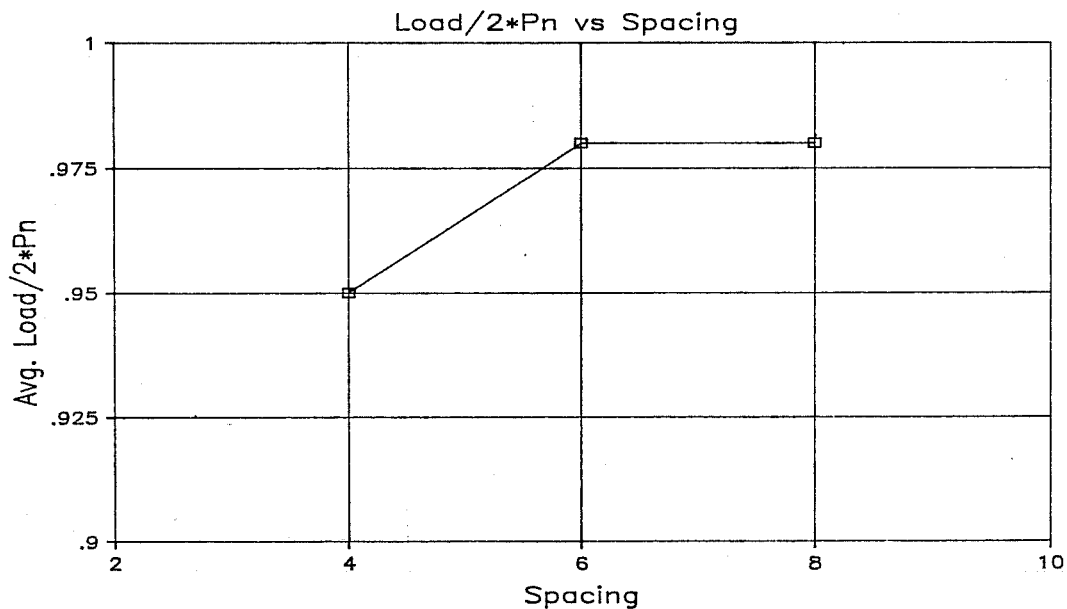

Fig. 6.4 Capacity per Anchor vs. Anchor Spacing

#### 6.4 Discussion of Results of Paired Anchor Tests

As the spacing of 5/8-inch adhesive anchors was decreased from 8 to 4 inches, several things occurred:

- 1) The radii of the concrete cones increased
- 2) The depths of the concrete cones increased
- 3) The number of overlapping cones increased
- 4) The number of anchors failing by steel fracture decreased
- 5) The ratio of experimental capacity to calculated capacity decreased slightly

Results from the paired anchor tests indicate that in the range of spacings studied, adhesive anchors were only slightly affected by close spacing of anchors. For most of the adhesives tested, at the closest spacing of 4 inches, the ultimate capacity for the pair was at least 80% of the capacity of two single anchors (Table 6.1). Capacities for single anchors were predicted using Equation 5.19 as recommended in Chapter 5, and were limited to the steel strength for Table 6.1. On average, for most of the adhesives, the experimentally determined capacity for paired anchors spaced at 4 inches is 95% of the combined predicted capacities of two single anchors.

Table 6.1 Results of Tests on Paired Adhesive Anchors

Adhesive	Spacing (in.)	Experimental Paired Load	2*P <sub>n</sub> Predicted	Experimental/ 2*P <sub>n</sub>
A1	4	58.8	62.6	0.94
	4	56.8	62.6	0.91
	6	62.2	62.6	0.99
	6	60.5	62.6	0.97
	8	62.4	62.6	1.00
A2	8	61.4	62.6	0.98
	4	50.0	45.5	1.10
	4	32.8	45.5	0.72
	6	42.3	45.5	0.93
	6	58.8	45.5	1.29
A3	8	40.8	45.5	0.90
	8	42.3	45.5	0.93
	4	59.6	62.6	0.95
	4	60.7	62.6	0.97
	6	58.1	62.6	0.93
A4	6	64.6	62.6	1.03
	8	58.6	62.6	0.94
	8	58.4	62.6	0.93
	4	52.0	62.6	0.83
	4	61.8	62.6	0.99
A5	6	37.8	62.6	0.60
	6	56.6	62.6	0.90
	8	62.3	62.6	1.00
	8	60.6	62.6	0.97
	4	60.4	54.8	1.10
A6	4	64.7	54.8	1.18
	6	62.2	54.8	1.13
	6	61.7	54.8	1.13
	8	62.3	54.8	1.14
	8	60.5	54.8	1.10
A6	4	57.2	62.6	0.91
	4	51.6	62.6	0.82
	6	60.6	62.6	0.97
	6	56.5	62.6	0.90
	8	54.1	62.6	0.86
	8	62.4	62.6	1.00



## CHAPTER 7. DESIGN RECOMMENDATIONS FOR ADHESIVE ANCHORS

### 7.1 Capacities of Single Adhesive Anchors

Although the load at which the cone forms cannot be accurately predicted, prediction of the ultimate capacity of any adhesive anchor can be based upon the partially bonded anchor, Case 1. Experimental results, see Figures 5.7(a)- 5.7(f), show that the capacity of a fully bonded anchor is only slightly greater than the capacity of a partially bonded anchor of the same embedment length. The ultimate capacity of any anchor can then be predicted by use of the Case 1 and Case 3 equations.

Based on experimental data, the concrete cone is approximately 1-1/2 inches deep for 5/8-inch diameter anchors. For anchors with diameters between 1/2 and 1 inch, cone depths should also be approximately 1-1/2 inches.

A conservative prediction of the nominal tensile strength of the embedment,  $T_e$ , for either a partially bonded anchor or a fully bonded anchor is given by the following equation:

$$T_e = \left( \frac{\pi u_{max} d^{1.5}}{\lambda'} \right) \tanh \left( \frac{\lambda' (l_e - 2)}{\sqrt{d}} \right) \quad (Eq. 7.1)$$

where:

$u_{max}$  = maximum calculated bond stress for the adhesive, determined as described in subsection 5.2.3,

$l_e$  = embedment length of the anchor,

$d$  = diameter of the hole,

$\lambda'$  = stiffness parameter for the adhesive (see subsection 5.2.3).

### 7.2 Design of Single Adhesive Anchors

Design procedures for single adhesive anchors can then be developed by applying appropriate load and resistance factors,  $\Phi$ , to Equation 7.1. The elastic

solution indicates that the capacity of an adhesive anchor, as governed by adhesive failure, does not increase as embedment is increased past a certain depth. For adhesive anchors in this embedment range, the resistance factors should be less conservative, because a shorter embedment will produce little variation in capacity. When the capacity calculated using Equation 7.1 is within 95% of the asymptote of the capacity curve, a resistance factor of 0.8 should be applied to the capacity. The asymptote of the curve can be calculated with the following formula:

$$Asymptote = \left( \frac{\pi u_{max} d^{1.5}}{\lambda'} \right) \quad (Eq. 7.2)$$

When the computed capacity from Equation 7.1 is less than 95% of the asymptote, a resistance factor of only 0.65 should be used. This lower resistance factor accounts for a greater drop in capacity with decreasing embedment length along this portion of the capacity curve.

The following resistance factors,  $\Phi$ , are recommended:

$$\Phi = 0.80, \text{ when } T_e \geq 0.95 \left( \frac{\pi u_{max} d^{1.5}}{\lambda'} \right) \quad (Eq. 7.3)$$

$$\Phi = 0.65, \text{ when } T_e < 0.95 \left( \frac{\pi u_{max} d^{1.5}}{\lambda'} \right) \quad (Eq. 7.4)$$

These resistance factors, applied to the capacity found using Equation 7.1, will ensure a ductile anchorage:

$$\Phi T_e \geq A_s f_{ut}, \quad (Eq. 7.5)$$

where:

$A_s$  = area of steel,  $f_{ut}$  = ultimate tensile capacity of steel.

### 7.3 Design of Grouped Adhesive Anchors

The chief reason for the reduction in capacity for groups of anchors is the effect of overlapping failure cones. No tests were conducted on pairs of partially bonded anchors (less than 8 inches), but it is expected that there would be little if any reduction in capacity for close spacings of these anchors. Because a properly designed partially bonded anchor should not produce a concrete cone, such anchors should experience little if any reduction in strength due to group effects. Fully bonded adhesive anchors will have overlapping failure cones at close spacings. The overlap is small and causes a correspondingly small reduction in capacity as stated in Chapter 6.

For design purposes, however, some reduction in capacity should be assumed for all closely spaced adhesive anchors until more extensive testing confirms that such reductions are negligible.

For anchors with a hole diameter between 0.5 inches and 1 inch, a capacity reduction of 15% is suggested for spacings between 4 and 8 inches. No data were obtained in this study for spacings less than 4 inches. For spacings of 8 inches or more, no reduction in capacity is required. In other words, no reduction due to group effects is assumed in calculating the embedment necessary to produce a ductile connection.

$$T_{ec} = 0.85 N_a T_e, \quad (\text{Eq. 7.6})$$

for spacings between 4 and 8 inches.

$$T_{ec} = N_a T_e, \quad (\text{Eq. 7.7})$$

for spacings > 8 inches.                      where:

$T_e$  = the nominal tensile strength of a single embedment, as defined in Section 7.1,

$T_{ec}$  = the nominal tensile strength of the connection,

$N_a$  = the number of anchors in the connection.

In order to assure a ductile anchorage the following limit is recommended:

$$\Phi T_{ec} \geq N_a A_s f_{ut} \quad (\text{Eq. 7.8})$$

where:

$\Phi$  = the reduction factor as described in Section 7.1.



## CHAPTER 8. SUMMARY, CONCLUSIONS, AND RECOMMENDATIONS

### 8.1 Summary

The purpose of this study was to investigate the behavior of retrofit adhesive anchors in concrete in order to develop a rational design procedure for these anchors. The study involved 105 tensile tests. These tests included the following:

- 1) Fully bonded single anchors with embedment depths of 4 inches and 6 inches (26 tests)
- 2) Partially bonded single anchors with embedment depths of 4, 6, and 8 inches (36 tests)
- 3) Fully bonded anchor pairs at spacings of 4, 6, and 8 inches (36 tests)
- 4) Miscellaneous tests to supplement a study conducted by Collins [1] (see Appendix C).

All anchors were 5/8-inch nominal diameter, high-strength threaded rod. Concrete meeting the Texas State Department of Highways and Public Transportation's specifications for Class C concrete was used for all tests.

Results of the tests presented in this thesis should be interpreted under the following conditions:

- a) Results are strictly valid only for the adhesives tested in this study and the conditions under which they were studied.
- b) Results of these tests could be modified as a result of changes in adhesive specifications, concrete type, installation procedures, or testing environment.
- c) Results should not be construed to imply that all adhesives of a given type are better than all adhesives of another type.
- d) Results should not be construed as an endorsement of any particular anchor type or brand.
- e) Results do not include the effects of environmental behavior.

The following behavior was observed:

#### Fully Bonded Single Anchors

Fully bonded single anchors failed in two ways. Fully bonded adhesive anchors (5/8" threaded rods) failed by formation of a shallow concrete cone with an average depth between 1 and 2 inches. Below the tip of the cone, the adhesive core surrounding the anchor pulled out of the concrete. Other fully bonded adhesive anchors failed by fracture of the anchor steel.

#### Partially Bonded Single Anchor Tests

Partially bonded single anchors failed by either pullout of an adhesive core or by fracture of the anchor steel. No concrete cones were formed with the partially bonded adhesive anchors.

#### Paired Anchor Tests

Fully bonded paired anchors had the same failure modes as fully bonded single anchors. At close spacings, the concrete cones overlapped and produced a unified concrete cone for the anchor pair.

## **8.2 Conclusions**

*8.2.1 Behavioral Model.* Based on the test results of 5/8" anchors reported herein and elsewhere the following conclusions on adhesive anchor behavior have been drawn:

- 1) Fully bonded adhesive anchors not exhibiting steel failure form a concrete cone with an average depth between 1 and 2 inches. If the top 2 inches of embedment are debonded, the concrete cone does not form, and the failure mode is a bond failure.
- 2) The capacity of a partially bonded anchor is approximately equal to that of a fully bonded anchor with the same embedment depth; that is, in a hole of the same depth.
- 3) The bond stress distribution for an adhesive anchor can be found using an elastic solution.

- 4) The maximum bond stress can be found using results of tests on partially bonded anchors, as discussed in Subsection 5.1.2.
- 5) After formation of a concrete cone, the bond does not necessarily fail throughout the bonded length. The remaining length over which bond acts is capable of developing a larger capacity than that required to form the cone.

*8.2.2 Spacing Effects.* Based on test results reported herein, the following conclusions regarding effects of close spacing on adhesive anchors have been drawn:

- 1) Reductions in anchor capacity of closely spaced anchors are linked to formation of overlapping concrete cones.
- 2) Because fully bonded adhesive anchors form a cone with an average depth of 1 to 2 inches, anchors must be within about 4 inches of one another to have overlapping cones.
- 3) The effect of close spacing on fully bonded adhesive anchors is minimal. On average, for the anchors tested, spacings as small as 4 inches produced ultimate loads 95% as high as those expected for two single anchors.

### **8.3 Recommendations for Design**

Design recommendations are discussed fully in Chapter 7. Detailed design recommendation can be found in the design guide produced as Report 1126-4F of this project.

In the design guide, no distinction is made between fully bonded and partially bonded single anchors, because test results indicated no significant difference between capacities of these two types of anchors. All anchors should be designed using the capacity equation outlined in Chapter 7. This capacity prediction is based on the behavior of the partially bonded anchor, because this case is simpler than the fully bonded anchor and yields conservative results for the fully bonded anchor.

For anchor groups, a reduction in nominal capacity is recommended for both fully bonded and partially bonded anchors spaced closer than 8 inches.

#### 8.4 Recommendations for Further Research

Based on the results reported in this study, the following additional research is recommended:

- 1) Investigate the effects of even closer spacings on partially bonded adhesive anchors.
- 2) Investigate the optimum depths of debonding for partially bonded anchors with various embedment depths, anchor diameters, adhesives, and concrete strengths.
- 3) Investigate the behavior of a fully bonded anchor at the time of cone formation. This would require additional tests using anchors large enough in diameter to produce cone failures at steel stresses below yield. These tests should be conducted on fully bonded anchors of various diameters and embedment depths.
- 4) Investigate the effects of environmental factors on behavior of in-place adhesive anchors. This would include the effects of ultraviolet light and freeze-thaw cycling.
- 5) Investigate the behavior of anchors subjected to various environmental factors during placement of the anchors. This would include effects of temperature, moisture in the hole, and presence of sulfates at time of placement.

**APPENDIX A**  
**COMPLETE TEST RESULTS**  
**FOR SINGLE ANCHORS**

TEST	ANCHORS PER TEST	Le	Lb	ANCHOR SPACING	Pult	STEEL FAILURE?	CONE DEPTH
A1E41	ONE	4"	4"	-	20.7 k	NO	4"
A1E42	ONE	4"	4"	-	19.5 k	NO	2.25"
A1E61	ONE	6"	6"	-	30.5 k	NO	2"
A1E62	ONE	6"	6"	-	20.3 k	NO	1.75"
A1E63	ONE	6"	6"	-	23.9 k	NO	1.75"
A2E41	ONE	4"	4"	-	14.6 k	NO	2"
A2E42	ONE	4"	4"	-	15.0 k	NO	2"
A2E61	ONE	6"	6"	-	21.5 k	NO	1"
A2E62	ONE	6"	6"	-	25.6 k	NO	0.75"
A3E41	ONE	4"	4"	-	20.3 k	NO	1.5"
A3E42	ONE	4"	4"	-	17.1 k	NO	1"
A3E61	ONE	6"	6"	-	28.5 k	NO	1.75"
A3E62	ONE	6"	6"	-	32.5 k	YES	-
A4E41	ONE	4"	4"	-	9.0 k	NO	1.5"
A4E42	ONE	4"	4"	-	17.6 k	NO	1"
A4E61	ONE	6"	6"	-	26.3 k	NO	1.25"
A4E62	ONE	6"	6"	-	20.0 k	NO	1"
A5E41	ONE	4"	4"	-	21.0 k	NO	2.25"
A5E41	ONE	4"	4"	-	23.2 k	NO	4"
A5E61	ONE	6"	6"	-	22.9 k	NO	2"
A5E62	ONE	6"	6"	-	30.2 k	NO	1"
A6E41	ONE	4"	4"	-	18.8 k	NO	2"
A6E42	ONE	4"	4"	-	21.5 k	NO	1.75"
A6E61	ONE	6"	6"	-	25.1 k	NO	2.25"
A6E62	ONE	6"	6"	-	30.0 k	NO	2.5"

TEST	ANCHORS PER TEST	Le	Lb	ANCHOR SPACING	Pult	STEEL FAILURE?	CONE DEPTH
A1B41	ONE	4"	2"	-	19.2 k	NO	-
A1B42	ONE	4"	2"	-	17.5 k	NO	-
A1B61	ONE	6"	4"	-	26.0 k	NO	-
A1B62	ONE	6"	4"	-	30.0 k	NO	-
A1B81	ONE	8"	6"	-	30.3 k	NO	-
A1B82	ONE	8"	6"	-	31.7 k	NO	-
A2B41	ONE	4"	2"	-	12.4 k	NO	-
A2B42	ONE	4"	2"	-	9.0 k	NO	-
A2B61	ONE	6"	4"	-	21.5 k	NO	-
A2B62	ONE	6"	4"	-	14.4 k	NO	-
A2B81	ONE	8"	6"	-	29.5 k	NO	-
A2B82	ONE	8"	6"	-	28.3 k	NO	-
A3B41	ONE	4"	2"	-	11.9 k	NO	-
A3B42	ONE	4"	2"	-	14.8 k	NO	-
A3B61	ONE	6"	4"	-	24.4 k	NO	-
A3B62	ONE	6"	4"	-	25.1 k	NO	-
A3B81	ONE	8"	6"	-	30.7 k	NO	-
A3B82	ONE	8"	6"	-	31.1 k	NO	-
A4B41	ONE	4"	2"	-	14.6 k	NO	-
A4B42	ONE	4"	2"	-	15.4 k	NO	-
A4B61	ONE	6"	4"	-	23.2 k	NO	-
A4B62	ONE	6"	4"	-	30.7 k	NO	-
A4B81	ONE	8"	6"	-	32.2 k	YES	-
A4B82	ONE	8"	6"	-	29.8 k	NO	-
A5B41	ONE	4"	2"	-	18.5 k	NO	-
A5B42	ONE	4"	2"	-	18.5 k	NO	-
A5B61	ONE	6"	4"	-	25.6 k	NO	-
A5B62	ONE	6"	4"	-	22.4 k	NO	-
A5B81	ONE	8"	6"	-	30.0 k	NO	-
A5B82	ONE	8"	6"	-	21.5 k	NO	-
A6B41	ONE	4"	2"	-	19.5 k	NO	-
A6B42	ONE	4"	2"	-	14.8 k	NO	-
A6B61	ONE	6"	4"	-	24.4 k	NO	-
A6B62	ONE	6"	4"	-	29.3 k	NO	-
A6B81	ONE	8"	6"	-	31.0 k	NO	-
A6B82	ONE	8"	6"	-	29.2 k	NO	-





**APPENDIX B  
COMPLETE TEST RESULTS  
FOR PAIRED ANCHORS**

TEST	ANCHORS PER TEST	Le	Lb	ANCHOR SPACING	Pult	STEEL FAILURE?	CONE DEPTH
A1S41	TWO	8"	8"	4"	58.8 k	NO	2"
A1S42	TWO	8"	8"	4"	56.8 k	NO	1.75"
A1S61	TWO	8"	8"	6"	62.2 k	NO	2"
A1S62	TWO	8"	8"	6"	60.5 k	NO	1.75"
A1S81	TWO	8"	8"	8"	62.4 k	NO	1"
A1S82	TWO	8"	8"	8"	61.4 k	NO	.75"
A2S41	TWO	8"	8"	4"	50.0 k	NO	2"
A2S42	TWO	8"	8"	4"	32.8 k	NO	2.25"
A2S61	TWO	8"	8"	6"	42.3 k	NO	2"
A2S62	TWO	8"	8"	6"	58.8 k	NO	2.25"
A2S81	TWO	8"	8"	8"	40.8 k	NO	1"
A2S82	TWO	8"	8"	8"	42.3 k	NO	1.5"
A3S41	TWO	8"	8"	4"	59.6 k	NO	2"
A3S42	TWO	8"	8"	4"	60.7 k	NO	1.5"
A3S61	TWO	8"	8"	6"	58.1 k	NO	1.75"
A3S62	TWO	8"	8"	6"	64.6 k	YES	1.5"
A3S81	TWO	8"	8"	8"	58.6 k	NO	1"
A3S82	TWO	8"	8"	8"	58.4 k	NO	0.75"
A4S41	TWO	8"	8"	4"	52.0 k	NO	2"
A4S42	TWO	8"	8"	4"	61.8 k	NO	1.75"
A4S61	TWO	8"	8"	6"	37.8 k	NO	2"
A4S62	TWO	8"	8"	6"	56.6 k	NO	1.75"
A4S81	TWO	8"	8"	8"	62.3 k	YES	1"
A4S82	TWO	8"	8"	8"	60.6 k	NO	1.5"
A5S41	TWO	8"	8"	4"	60.4 k	NO	2"
A5S42	TWO	8"	8"	4"	64.7 k	YES	2.25"
A5S61	TWO	8"	8"	6"	62.2 k	YES	2"
A5S62	TWO	8"	8"	6"	61.7 k	NO	2.25"
A5S81	TWO	8"	8"	8"	62.3 k	NO	1"
A5S82	TWO	8"	8"	8"	60.5 k	YES	1.5"
A6S41	TWO	8"	8"	4"	57.2 k	NO	2"
A6S42	TWO	8"	8"	4"	51.6 k	NO	1.75"
A6S61	TWO	8"	8"	6"	60.6 k	YES	2"
A6S62	TWO	8"	8"	6"	56.5 k	NO	1.5"
A6S81	TWO	8"	8"	8"	54.1 k	NO	1.0"
A6S82	TWO	8"	8"	8"	62.4 k	NO	.75"

**APPENDIX C**  
**COMPLETE TEST RESULTS**  
**FOR SUPPLEMENT TO COLLINS TEST [1]**

TEST	ANCHORS PER TEST	Le	Lb	ANCHOR SPACING	Pult	STEEL FAILURE?	CONE DEPTH
A1St71	ONE	8"	8"	-	32.45 k	NO	-
A1St72	ONE	8"	8"	-	26.84 k	NO	-
A1St81	ONE	8"	8"	-	30.6 k	YES	-
A1St82	ONE	8"	8"	-	30.5 k	YES	-
A4H61	ONE	6"	6"	-	21.6 k	NO	3.5"
A4H81	ONE	8"	8"	-	30.5 k	NO	1.5"
A4H82	ONE	8"	8"	-	31.6 k	NO	1.75"

## REFERENCES

1. Collins, David, "Load-Deflection Behavior of Cast-In-Place and Retrofit Concrete Anchors Subjected to Static, Fatigue, and Impact Tensile Loads," Master's Thesis, The University of Texas at Austin, May, 1988.
2. ACI Committee 349, **Code Requirements for Nuclear Safety Related Structures**, (ACI 349-83), American Concrete Institute, Detroit, Michigan, 1983.
3. **PCI Design Handbook-Precast and Prestressed Concrete**, 2nd Edition, Prestressed Concrete Institute, Chicago, 1978.
4. **PCI Manual for Structural Design of Architectural Precast Concrete**, Prestressed Concrete Institute, Chicago, 1977.
5. James, R.W., De la Guardia, C., and McCreary, C.R., "Strength of Epoxy-Grouted Anchor Bolts in Concrete," **ASCE Journal of Structural Engineering**, Vol. 113 No. 12, December 1987, pp. 2365-2381.
6. Wilson, F., "The A,B,C's of Epoxy Grouting," Paper presented to The Gas Compressor Institute, University of Oklahoma, Wil- Cor, Inc., Pasadena, TX.
7. Lee, H.L. and Lawrence, N., **Handbook of Epoxy Resins**, McGraw-Hill, New York, 1969, 869 pp.
8. Peier, Walter H., "Model for Pull-out Strength of Anchors in Concrete," **ASCE Journal of Structural Engineering**, Vol. 109 No. 5, May 1983, pp. 1155-1173.
9. Beveridge, R.L.W., "Resin Anchors," **Civil Engineering (British)**, Morgan-Grampian Professional Press Ltd., August 1976, pp. 71-75.
10. Daws, G., "Resin Anchors," Parts I and II, **Civil Engineering (British)**, Morgan-Grampian Professional Press Ltd., October 1978, pp. 71-75, December 1978, pp. 61-63.
11. Davies, Peter, "Epoxy Structural Adhesives," **Civil Engineering (British)**, Morgan-Grampian Professional Press Ltd., August 1976, pp. 77-81.

12. **Technical Guide for Anchor and Power Actuated Fastening**, Hilti, Corp. Product Guide, 1987.
13. Dusel, John P. Jr. and Bon, Vu Dinh, "Determination of Minimum Embedment Depth For Polyester Resin Capsule Anchors Securing Bridge-Mounted Signs," Report No. FHWA/CA/TL-85/03, California Department of Transportation, February 1985.
14. Lee, N. K., Mayfield, B., and Snell, C., "Resin Anchors in Concrete," Parts I and II, **Civil Engineering** (British), Morgan-Grampian Press Ltd., April 1980, pp. 35-41, June 1980, pp. 47-53.
15. Luke, Philip Chi Chung, "Strength and Behavior of Rebar Dowels Epoxy-Bonded in Hardened Concrete," Unpublished Master's Thesis, Civil Engineering Department, The University of Texas at Austin, May 1984.
16. Cannon, R. W., Godfrey, D. A., and Moreadith, F. L., "Guide to the Design of Anchor Bolts and Other Steel Embedments," **Concrete International**, Vol. 3, No. 7, July 1981.
17. Doyle, E. N., **The Development and Use of Polyester Products**, McGraw-Hill, New York, 1969, 365 pp.
18. Wiewel, Harry, **EPCON Ceramic 6 Epoxy Anchor Tests- Results of Tests on the ITW Ramset EPCON System**, Techmar, Inc. Test Report, Long Beach, California, 1988.