

# Ferguson Structural Engineering Lab Newsletter



Volume 10, Issue 1

THE UNIVERSITY OF TEXAS AT AUSTIN - STRUCTURAL ENGINEERING

Fall 2018

## Fall Semester Kickoff BBQ!

Ferguson Lab once again celebrated the return of a new school year with our Fall BBQ tradition. Research projects were on display, incoming students made introductions, and the beer and BBQ were plentiful.



## New Faces at FSEL

### Sangwook Park



I am a first-year PhD student in UT. I am from South Korea, and I received BS and MS in architectural engineering from Yonsei University. My research is focusing on the Earthquake Engineering with structures. I recently joined the project: System Level Seismic Performance of Steel Gravity Framing (NSF project). I often work out in Gregory gym and enjoy watching all kinds of sports games in my free time. I am glad be studying and working in FSEL.

## Annual Flag Football Game!

The flag football game took place earlier this fall with a great turnout. Thanks to Walter P Moore for providing BBQ and helping make this even a success!

### Yamamoto Naoki

I'm a second-year Master's student of Kyoto University, Japan. Currently, I'm here as an exchange student, working on delamination of curved post-tensioned concrete project with Dr. Jongkwon Choi. My own research project is about steel columns though. I'm really glad to be here as a member at FSEL. I'm here only this semester but I hope I can communicate with people as much as I can. In my spare time I enjoy Netflix.

### Inside this issue:

- |  |   |
|--|---|
| INVESTIGATION OF LIMIT STATE BEHAVIOR OF PT STEEL BEAM-TO-COL CONN DUE TO LOCAL BUCKLING | 2 |
| STATIC TESTS OF BREAKAWAY CONN, DAMAGE ASSESSMENT OF RC BENT CAPS                        | 3 |
| STM OF DRILLED SHAFT FTG, MECH CHAR OF STRUCT CONC USING DIC                             | 4 |
| DIAGONAL CRACKING OF BRIDGE MEMBERS, FEA OF THE SEISMIC RESPONSE OF RC COL               | 5 |
| CORROSION MONITORING OF PT STRANDS, IMPROVED TUB GIRDER DTLS                             | 6 |

# Ferguson Structural Engineering Lab Newsletter

## Florentia Kavoura



I was born and raised in Greece. I received my Bachelor's and Master's degrees from the University of Cyprus and my Ph.D. degree from the University of Houston. For my Master's research I examined the seismic performance of high-rise buildings according to Eurocodes provisions. During my doctoral studies, I investigated the influence of column to base-plate connection stiffness on the design of metal buildings. Currently, I am a Post-doctoral Research Fellow at UT Austin and I am working under the supervision of Prof. Helwig and Prof. Engelhardt on a research focused on the evaluation of the performance of breakaway connections. I am excited to be part of the FSEL team!

## Investigation of Limit State Behavior of Post-tensioned Steel Beam-to-Column Connections due to Local Buckling - Sedef Kocakaplan

Self-centering moment resisting frames with post-tensioned (PT) beam-to-column connections have been proposed as a damage-mitigating alternative to conventional moment-resisting frames used in seismic force-resisting structural systems. The self-centering capability of properly designed PT connections proves to be an effective tool for improving resilience of building following an earthquake; however, the rocking behavior of PT beam-to-column connections could result in excessive compressive forces at the contact surfaces between beams and columns. These compressive forces can cause local buckling at beam flanges. To address the beam local buckling, we performed finite element analysis. To vali-

date our finite element models, we used the experiments conducted by Hulsey (2015). Next semester, we will perform a parametric computational study through finite element methods and compare our results with AISC

Seismic Provisions (2016) for flange and web width-to-thickness limits of beams for PT beam-to-column connections.

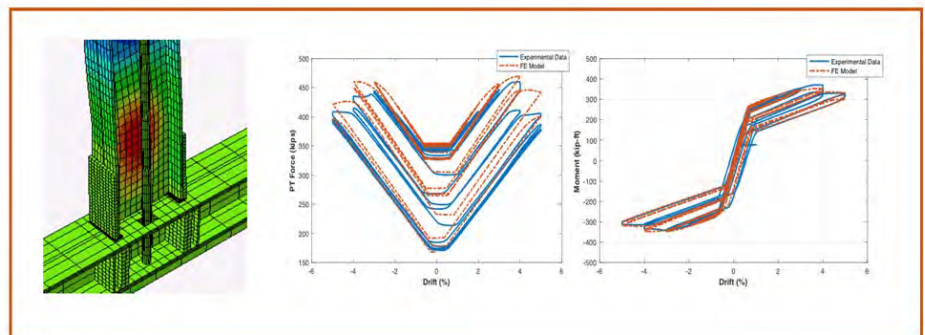

## Static Tests of Breakaway Connections - Florentia Kavoura

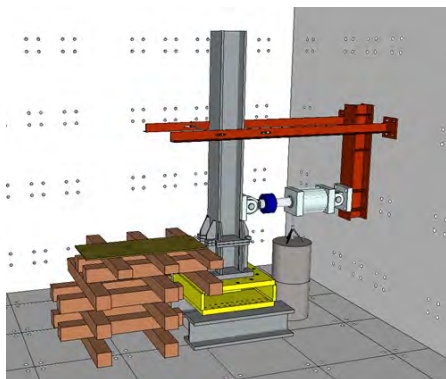

This research program examines the behavior of a proposed breakaway base connection for catenary poles. The experimental work is conducted at the Ferguson Structural Engineering Laboratory and it is funded by Protec-

tion Engineering Consultants (PEC). The scope of this research focuses on the development of a resilient wayside structure that can reduce passenger injury/fatality risk by lessening the amount of intrusion, penetration, and passenger motion during a derailment event.

The experimental program of the research is divided into two phases. The first phase includes six standard slip plate tests. These slip tests determine the slip coefficient of the galvanized surfaces in contact during the full-scale experiments. The second phase of the experimental program includes full-scale experiments of the proposed breakaway connection, in order to evaluate the performance of the

breakaway connection under static loads. The test matrix of the full-scale specimens includes tests where the connection is loaded along both principal axes of the column and the load is applied at two different heights: adjacent to the slip plane and farther up the column section. It is expected this catenary pole base breakaway connection could have a substantial impact on railway safety.

## Damage Assessment of Decommissioned Reinforced Concrete Bent Caps - Bernardo Perez

The objective of this research is to assess two recently decommissioned reinforced concrete bent caps from Interstate Highway 20 and State Highway 351 in Texas. This research will provide experimental results to provide insight into the performance of real-world bridge components under distributed loading conditions. The primary tasks associated with this research are: site inspection, lab inspection after removal, ultimate load testing, carbon fiber reinforced polymer (CFRP) retrofit, and data synthesis and analysis.

The ultimate load test for the first bent cap has been completed. Currently, the critical spans of the second bent cap are in the process of being retrofitted using CFRP. Such retrofit will bring in-

sight on the performance CFRP under shear loads. Additionally, the material properties of the first bent cap have been determined.



# Ferguson Structural Engineering Lab Newsletter

## Strut-and-Tie Modeling and Design of Drilled Shaft Footings - Yousun Yi, Dennis Kim, Ryan Boehm, and Stephan Mühlberg

The design and detailing of reinforced concrete footings supported by a grid of drilled shafts varies greatly on a state, district, and even municipality basis due to the continued use of legacy; sectional design method. Therefore, a full transition to strut-and-tie modeling is required for uniform design and detailing of shaft-supported footings. This project hopes to refine the STM guidelines for 2D structures to those for 3D structures; shaft-supported footings through experimental and analytical approaches.

During the fall 2018 semester, the first four specimens have been tested. After analyzing the test results, the team will decide on the reinforcement layout (grid or banded layout of bottom mat

reinforcement) that will be used for subsequent specimens. This decision is based on multiple factors including strength, serviceability, and constructability. After the rebar layout is decided, fabrication of the next series will begin, and the specimens will be cast before winter break.



## Mechanical Characterization of Structural Concrete using Digital Image Correlation - Xiaoyi Chen

Digital image correlation (DIC) is a non-contact measurement method that provides full-field displacement and strain data of an object based on the comparison of digital images taken before and after deformation. The objective of this research is to experimentally characterize the complex mechanical response of concrete based on high-resolution deformation data obtained from a three-dimensional (3D) DIC system. Full-field deformation data obtained from standard material tests (such as, uniaxial compression, splitting tension, and three-point notched beam bending tests) will be used to extract valuable information about compressive/tensile strengths, elastic properties (modulus of elasticity and Poisson's ra-

tio), uniaxial stress-strain relations, strain localization and fracture process in concrete. Ultimately, DIC data will be used to validate and calibrate advanced constitutive models for concrete.

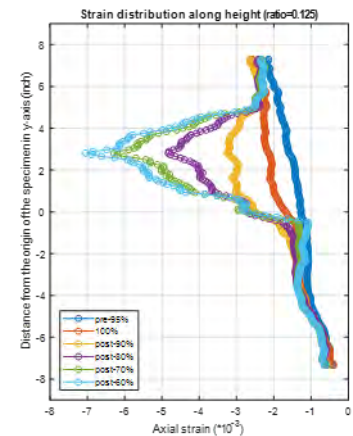
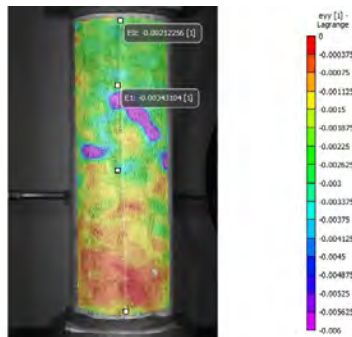

## Evaluation of Diagonally Cracking in Reinforced Concrete Bridge Members - Apostolos Athanasiou and Jarrod Zaborac

To bridge the gap between fast inspections and accuracy, the research team explored the application of fractal analysis in the inspection process. Inherent to that approach, it is assumed that the spatial properties of crack patterns can be used as a predictor for the estimation of damage and for the classification of different cracking types. Computational procedures (i.e., fractal and multifractal analyses) are used to pave the way toward explicit quantification and characterization of crack patterns. In this project, procedures are developed to extract data from crack patterns and to harvest those data for useful information that can relate cracking pattern properties to structural behavior properties and

response.

Additionally, a RC-mechanics based approach estimates stress-strain states based on crack width, spacing, and inclination. The results from analyses on an experimental database have shown that the procedure can provide reasonable estimates of structural residual capacity. Currently, work is being com-

pleted to validate additional modeling approaches and assumptions to refine the procedure.

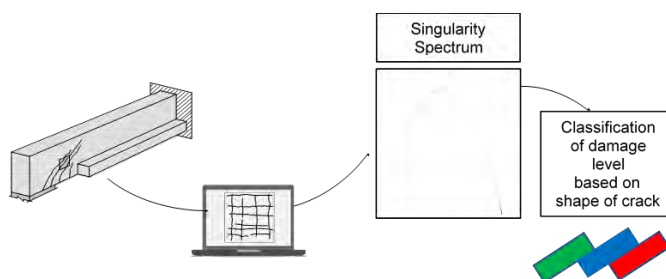

## Finite Element Analysis of the Seismic Response of RC Columns with Modified Bond Properties – Ghassan Fawaz

Reinforced concrete (RC) columns are critical components of the earthquake load-resisting systems of bridges and buildings. Current seismic design procedures favor the formation of plastic hinges in RC columns and other members to ensure a ductile structural response and avoid collapse during a severe earthquake. However, large strain concentrations in the longitudinal reinforcement of hinging components may lead to a premature fracture of steel and the failure of the component.

This research aims to: (1) develop accurate tools to simulate the seismic response of RC columns, and (2) investigate bond modification strategies to alleviate rebar strain concentrations and improve column performance.

Three-dimensional nonlinear finite element (FE) models of columns tested under cyclic lateral loading have been developed. The FE models comprise a triaxial constitutive model for concrete that is capable of simulating compression failure and tension cracking under cyclic loading. The bond-slip behavior of longitudinal reinforcing bars is modeled using a concrete-steel interface element. The interface element has a bond stress-slip constitutive law that predicts bond deterioration caused by bar slip, cyclic loading and tensile yielding of steel. The FE models are being used to study bond and anchorage modification strategies to alleviate strain concentrations and delay rupture of longitudinal steel bars. Currently, I

am also working on improving the steel model to capture rebar buckling and rupture due to low-cycle fatigue.

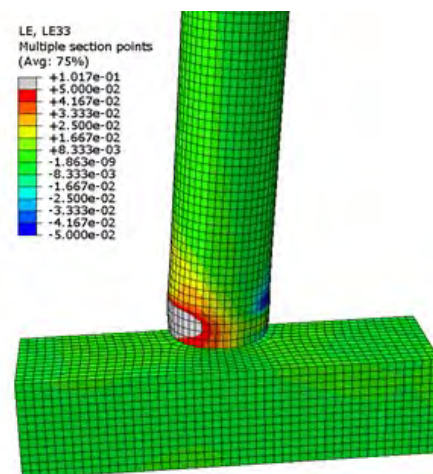

## Corrosion Monitoring of Prestressing Strands Using Guided Ultrasonic Waves (GUWs) - Brennan Dubuc and Arvin Ebrahimkhanlou

This project examines the suitability of a monitoring system based on guided ultrasonic waves (GUWs) for detecting the initiation and growth of corrosion damage in prestressed concrete beams. The objective of this project is to design, implement, and validate the use of an innovative monitoring system for the nondestructive evaluation of prestressed steel strands. The proposed monitoring system is based on low profile piezoelectric sensors, which have the capability of transmitting and receiving GUWs and can localize damage. The effects of accumulating corrosion and resulting prestress losses on GUW characteristics are studied, such as wave amplitude and velocity. Experiments on unbonded strands under

accelerated corrosion have been carried out. Upcoming experiments are also planned for studying the accelerated corrosion of small-scale prestressed concrete blocks.

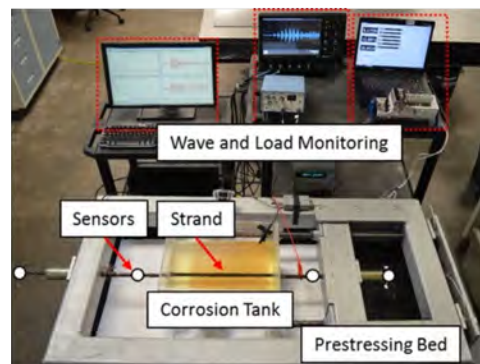
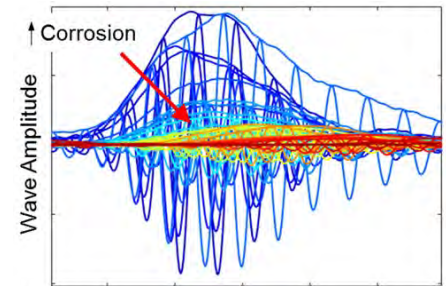

## Improved Tub Girder Details - Stalin Armijos M and Yang Wang

Steel trapezoidal box girders, known as tub girders, are a popular alternative in systems with large torsional demands, such as horizontal curved bridges, because of the torsional stiffness of their closed section. The objective of the current research study is to improve the economy and structural behavior of steel tub girders by modifying tub girder proportions and the bracing details for the girders.

The activities during the Fall 2018 semester include experimental ultimate-strength tests of our third tub girder which has been built with shallow webs. Two different configurations have been considered for the ultimate strength tests: a continuous and simply supported girder configuration. The three

specimens have been tested. For the continuous girder configuration, extensive yielding on top and bottom flanges, as well as in the webs, were observed; while for the simply supported configuration, the girders were pushed up to failure (crashing on concrete deck). In addition to the experimental part, extensive parametric finite element analysis are being carried out to extend the study of the details tested in the lab floor.

